



01
2023



HOSPITAL



CATALOGO HOSPITAL

La gamma **HOSPITAL LABEL** è progettata per permettere a progettisti e contractors di rispondere alle più diverse esigenze dei propri committenti con un prodotto dal **design elegante** che permetta una **customizzazione estrema**, mantenendo un eccellente rapporto qualità/prezzo.

La modularità delle diverse componenti consente un'infinita gamma di soluzioni rispondenti alle più stringenti **normative internazionali** relativamente ad automazioni per accessi controllati, laboratori, sale operatorie, sale radiologiche e spazi pubblici. Se volete la certezza di potere contare su un'azienda con una **presenza capillare** a livello internazionale, un servizio di **aftersales qualificato** e un **supporto tecnico** anche in fase di definizione di capitolati allora la gamma **HOSPITAL LABEL** è la scelta perfetta per voi.



CATALOGUE HOSPITAL

*The **HOSPITAL** range by **LABEL** is designed to enable designers and contractors to meet the different requirements of their customers with a product featuring an **elegant design** that allows an **extreme customization**, while maintaining an **excellent quality/price ratio**.*

*The modularity of the different components allows an infinite range of solutions to meet the most stringent **international regulations** relative to automations for controlled access, laboratories, operating theatres, radiology rooms and public spaces.*

*If you want to rely on a company with a **capillary presence** at international level, a **qualified aftersales service** and a **technical support** also during the definition of specifications, the **HOSPITAL** range by **LABEL** is the perfect choice for you.*



INDICE

Come scegliere le porte ospedaliere.....	4	COMPONENTI OPZIONALI	94
Guida alla gamma delle porte Hospital Label	6	Opzionali per porte automatiche scorrevoli e a battente	96
Come leggere i codici parlanti	10	Vetri speciali e finiture per porte vetrate	98
Struttura delle porte Label Hospital.....	12	Opzionali per porte vetrate	99
Porte vetrate.....	14	Imbotti, semi-imbotti ed estensioni.....	100
PORTE SCORREVOLI	16	Rivestimenti speciali e fasce	102
Porte scorrevoli automatiche a tenuta ermetica.....	18	Schermature in piombo per porte scorrevoli	104
Porte scorrevoli automatiche a tenuta ermetica heavy	22	Maniglie	108
Porte scorrevoli automatiche a tenuta semplice	24	Serrature.....	110
Porte scorrevoli manuali a tenuta ermetica	30	Interblocco	112
Porte scorrevoli manuali a tenuta semplice	34	Elettroblocchi e accessori	116
PORTE A BATTENTE	40	Dispositivi di impulso per porte automatiche	117
Porte automatiche a battente a tenuta semplice 75	42	Dispositivi di sicurezza, accessori per porte automatiche	118
Porte automatiche a battente asimmetriche a tenuta semplice 75	48	Batterie per porte automatiche	118
Porte automatiche a battente a tenuta semplice 150	50	Accessori per porte a battente	119
Porte automatiche a battente asimmetriche a tenuta semplice 150	56	Finiture	120
Porte automatiche a battente con lastre in piombo 150	58	MODULO DI RICHIESTA PER LA CONFIGURAZIONE	
Porte automatiche a battente asimmetriche con lastre in piombo 150	60	DELL'IMPIANTO	122
Porte automatiche a battente a tenuta semplice 300	62	ELENCO DELLE DIRETTIVE	
Porte automatiche a battente asimmetriche a tenuta semplice 300	68	E DELLE NORME EUROPEE DI RIFERIMENTO	124
Porte automatiche a battente con lastre in piombo 300	70	CONDIZIONI GENERALI DI VENDITA	
Porte manuali a battente a tenuta semplice	72	Disposizioni generali per trasporto e lo stoccaggio.....	128
Porte manuali a battente con lastre in piombo	78	Condizioni generali di vendita.....	130
PORTE SALVASPAZIO	80		
Porte scorrevoli telescopiche automatiche	82		
Porte automatiche a soffietto.....	86		
PORTE VETRATE ICU-CCU	88		
Porte vetrate scorrevoli automatiche - ICU-CCU	90		
Porte vetrate scorrevoli manuali - ICU-CCU	91		
Porte vetrate scorrevoli automatiche e manuali TLCA - ICU-CCU	92		

Note

La scelta di ciascuna porta dipende dalla destinazione e utilizzo: è fondamentale conoscere l'impiego previsto per ciascun prodotto e le sue funzionalità.

Le sale operatorie richiedono differenze di pressioni molto diverse fra loro in funzione della tipologia di intervento medico per cui sono adibite. In funzione dei sistemi di gestione dell'aria si possono utilizzare porte a tenuta semplice oppure porte a tenuta ermetica; tale indicazione deve essere decisa dal progettista che dispone degli elementi per la scelta.

Tutte le porte sono disponibili con pannellatura in acciaio Inox, laminata o vetrata; la scelta ottimale dipende dall'utilizzo delle porte e dalla loro destinazione.

In ogni ambito sia nei blocchi operatori, sia altri ambienti possono essere utilizzate le porte con finitura in laminato oppure acciaio.

Nelle ultime pagine del catalogo è disponibile un modulo grafico che vi guida nella configurazione della vostra porta.

The choice of each door depends on its destination and use: it is essential to know the intended use for each product and its features.

Operating rooms require very different pressure differences depending on the type of medical task for which they are used. Depending on the air management systems, simple sealing or hermetically sealing doors can be used; this must be established by the designer who has the information to make the choice.

All doors are available with stainless steel, HPL, or glazed panels; the optimal choice depends on the use of the doors and their destination. Doors with a HPL or steel finish can be used both in surgery areas and in other environments.

In the last pages of the catalogue there is a graphic module that guides you in the configuration of your door.

LE PORTE PER OSPEDALI LABEL

I sistemi di porte ospedaliere Label

Le porte scorrevoli o battenti per Ospedali Label possono essere richieste

- nella versione con apertura automatica o manuale
- con finitura HPL (125 colori base oppure colore RAL a richiesta), acciaio inox, o in alluminio-vetro
- con visive complanari, di varie dimensioni, dotate di tende interne elettriche o manuali.

Il sistema della porta in combinazione con il telaio/imbotte a muro soddisfa i più elevati requisiti in materia di norme asetticità, protezione dal rumore e dalle radiazioni. I certificati di prova sono disponibili su richiesta. Se è richiesto un livello più elevato di tenuta all'aria, possiamo dotare le nostre porte di un sistema di chiusura ermetica.

Ambienti di terapia intensiva e sub-intensiva

Normalmente si utilizzano porte dedicate che permettono sia una completa visibilità all'interno della sala, sia di garantire la privacy quando necessario.

In questi casi specifici le soluzioni ICU/CCU Label sono particolarmente efficienti soprattutto in abbinamento ai vetri LCD che permettono di passare da vetro trasparente ad opaco semplicemente sfiorando un pulsante.

Alcune applicazioni sono dotate di sistema a sfondamento integrale per soddisfare l'esigenza di avere l'intero vano di passaggio apribile per permettere il transito dei letti di degenza, delle strumentazione e degli accessori.

Come tutte le porte ospedaliere Label ogni soluzione ha la possibilità di essere equipaggiata anche con diversi accessori.

Soluzioni radiologiche e protezioni dai raggi

Per tutti quei contesti in cui vi è un'emissione di Raggi X, è possibile richiedere porte con all'interno una lamina di piombo (sono disponibili diversi spessori) per schermare dai raggi emessi dalle apparecchiature utilizzate all'interno delle sale.

La scelta dello spessore da utilizzare compete al progettista e al tecnico che in funzione della tipologia di apparecchiatura ne consiglia l'utilizzo.

Accessori ed elementi opzionali

Ogni soluzione ha la possibilità di essere equipaggiata anche con diversi accessori. È possibile scegliere fra diverse colorazioni, un'ampia gamma di maniglie, interblocchi per la gestione delle zone filtro e anche vari pulsanti e contatti di apertura/chiusura.

LABEL HOSPITAL DOORS

Label hospital door systems

Label sliding or swing doors for hospitals can be requested

- in automatic or manual opening version
- with HPL finish (125 basic colours or RAL colour on request), stainless steel, or aluminium-glass
- with flush vision panels, of various sizes, equipped with internal electric or manual blinds.

The door system together with the frame/wall frame meets the highest requirements in terms of asepticity, noise, and radiation protection regulations. Test certificates are available on request. If a higher level of air tightness is required, we can provide our doors with a hermetic seal system.

Intensive and sub-intensive care environments

Usually, dedicated doors are used that allow full visibility inside the room and at the same time guarantee privacy when necessary.

In these specific cases, ICU/CCU Label solutions are particularly efficient, especially in combination with LCD glass, which allows to switch from transparent to opaque glass with the touch of a button. Some applications are equipped with an integral breakout system to meet the need to have the entire passage opening openable to allow the transit of hospital beds, instruments, and accessories.

Like all Label hospital doors, each solution has the possibility to be equipped with different accessories.

X-ray solutions and radiation protection

For all those contexts where there is an emission of X-rays, it is possible to request doors with a lead foil inside (different thicknesses are available) to shield from the rays emitted by the equipment used inside the rooms.

The choice of the thickness to be used is the responsibility of the designer and the technician who selects it according to the type of equipment.

Accessories and optional items

Each solution has the possibility to be equipped with different accessories. It is possible to choose among different colours, a wide range of handles, interlocks for the management of the filter zones and also various buttons and opening/closing contacts.

LA SCELTA DELLA PORTA

La scelta della tipologia della porta si basa sulla richiesta di finitura del pannello e del tipo di prestazione che il locale in cui viene installata richiede:

- **Sale operatorie:** porta automatica con pannello in acciaio inox o laminato HPL, soluzione a tenuta semplice o ermetica, completamente cieca o con visiva.
- **Sale ICU o CCU:** porta con soluzione vetrata ampia o sistemi TLCA ad apertura totale del vano. Può essere automatica o manuale.
- **Area di servizio alle sale operatorie:** porta con pannello in acciaio inox o laminato HPL, soluzione a tenuta semplice o ermetica, completamente cieche o con visive, soluzione con vetrata ampia, sistemi di TLCA ad apertura totale del vano. Può essere automatica o manuale.
- **Aree Laboratori o Radiologiche:** porta con pannello in acciaio inox o laminato HPL, soluzione a tenuta semplice o ermetica, completamente cieca o con visiva. Può avere la schermatura ai raggi RX in piombo di diverso spessore: 1, 2, 3 o 4 mm in base alla richiesta del fisico progettista.

L'IGIENE E AFFIDABILITÀ SONO LE PRIORITÀ

I sistemi di porte ospedaliere Label sono progettati per agevolare le operazioni di pulizia e manutenzione perché l'igiene in un ospedale è una priorità imprescindibile.

I sistemi di apertura automatica, con pulsante a gomito o con sensore a sfioramento concorrono a rendere più agevole il transito tra i diversi locali evitando il contatto diretto con la maniglia che può essere un luogo di trasmissione dei batteri.

Le Visive sono installate complanari alla pannellatura per evitare il permanere dello sporco e facilitare la pulizia delle superfici; per la stessa ragione sono disponibili con tendine manuali o elettriche interne al vetro, con sistema Smart Glass e con o senza protezione dai Raggi X.

THE CHOICE OF THE DOOR

The choice of the door type is based on the panel finish and the type of performance required by the room in which it is installed:

- **Operating rooms:** automatic door with stainless steel or HPL panel, simple or hermetic sealing solution, completely blind or with vision panel.
- **ICU or CCU rooms:** door with wide glazed solution or TLCA systems which enable full passage opening. It can be either automatic or manual.
- **Service area for operating rooms:** Door with stainless steel or HPL panel, simple or hermetic sealing solution, completely blind or with vision panel, solution with wide glazing, TLCA systems which enable full passage opening. It can be either automatic or manual.
- **Labs and X-ray rooms:** automatic door with stainless steel or HPL panel, simple or hermetic sealing, completely blind or with vision panel. It can have a lead X-ray shielding of different thickness: 1, 2, 3, or 4 mm ($\frac{1}{8}$ ", $\frac{1}{6}$ ", $\frac{1}{4}$ " or $\frac{3}{16}$ "") depending on the request of the designer.

HYGIENE AND RELIABILITY ARE OUR PRIORITIES

Label hospital door systems are designed to facilitate cleaning and maintenance because hygiene in a hospital is a top priority.

The automatic opening systems, with elbow push button or touch sensor help make the transit between the different rooms easier by avoiding direct contact with the handle which can be a place of transmission of bacteria.

Vision panels are installed flush with the panels to prevent dirt settlement and ease surface cleaning; for the same reason they are available with manual or electric blinds inside the glass, with Smart Glass system and with or without X-ray protection.









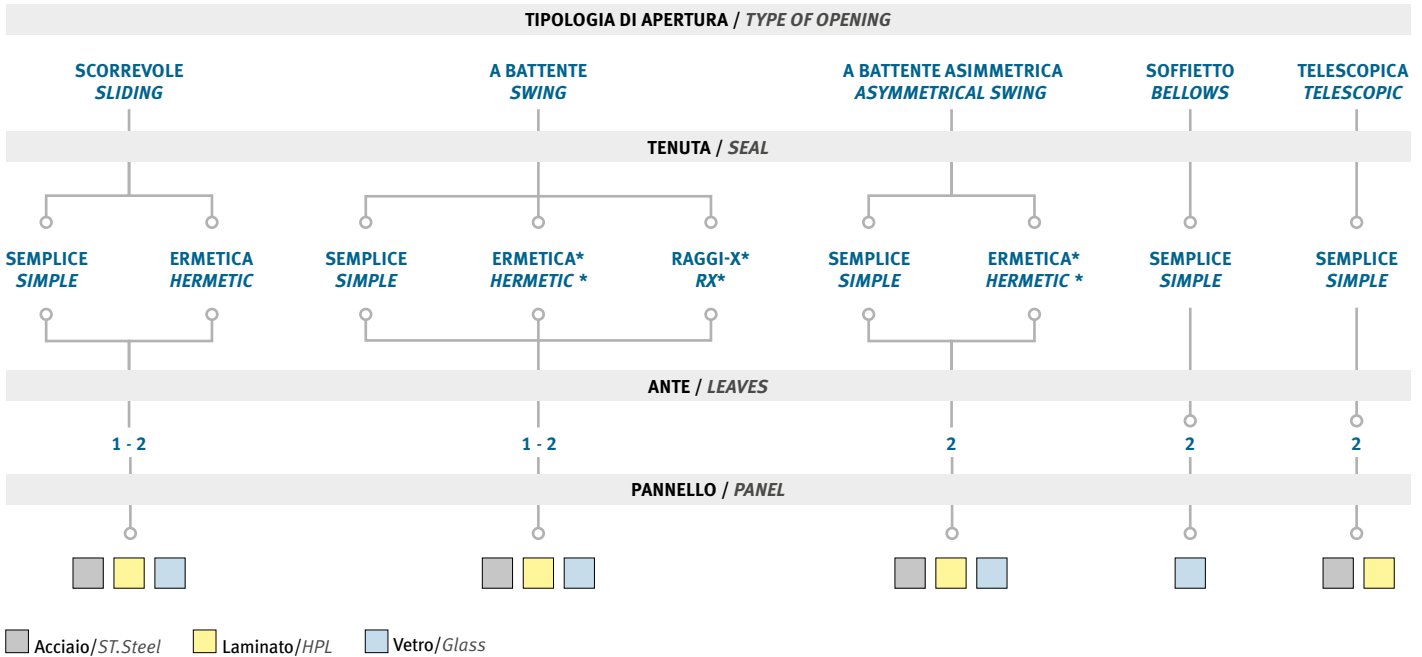

GUIDA ALLA GAMMA DELLE PORTE HOSPITAL LABEL

La gamma Porte HOSPITAL LABEL è progettata per permettere a progettisti e contractors di rispondere alle più diverse esigenze dei propri committenti con un prodotto dal design elegante che permetta una customizzazione estrema, mantenendo un eccellente rapporto qualità/prezzo.

La modularità delle diverse componenti consente un'infinita gamma di soluzioni rispondenti alle più stringenti normative internazionali relativamente ad automazioni per accessi controllati, laboratori, sale operatorie, sale radiologiche e spazi pubblici.

Porte Automatiche/Automatic Doors

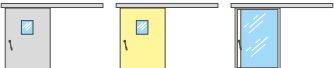

MODELLI PORTE / DOOR MODELS	TIPOLOGIA / TYPE	MODELLI PORTE / DOOR MODELS	TIPOLOGIA / TYPE
	Automatica Scorrevole 1 Anta <i>Automatic Sliding 1 Leaf</i>		Manuale Scorrevole 2 Ante <i>Manual Sliding 2 Leaves</i>
	Automatica Scorrevole 2 Ante <i>Automatic Sliding 2 Leaves</i>		Automatica A Battente A Battente Asimmetrica 2 Ante <i>Automatic Swing Asymmetrical Swing 2 Leaves</i>
	Automatica A Battente 1 Anta <i>Automatic Swing 1 Leaf</i>		Manuale A Battente 1 Anta <i>Manual Swing 1 Leaf</i>
	Manuale Scorrevole 1 Anta <i>Manual Sliding 1 Leaf</i>		Manuale A Battente A Battente Asimmetrica 2 Ante <i>Manual Swing Asymmetrical Swing 2 Leaves</i>

GUIDE TO THE LABEL HOSPITAL DOOR RANGE

The **HOSPITAL range by LABEL** is designed to enable designers and contractors to meet the different requirements of their customers with a product featuring an elegant design that allows an extreme customization, while maintaining an excellent quality/price ratio.

The modularity of the different components allows an infinite range of solutions to meet the most stringent international regulations relative to automations for **controlled access, laboratories, operating theatres, radiology rooms and public spaces.**

Porte Manuali/Manual Doors

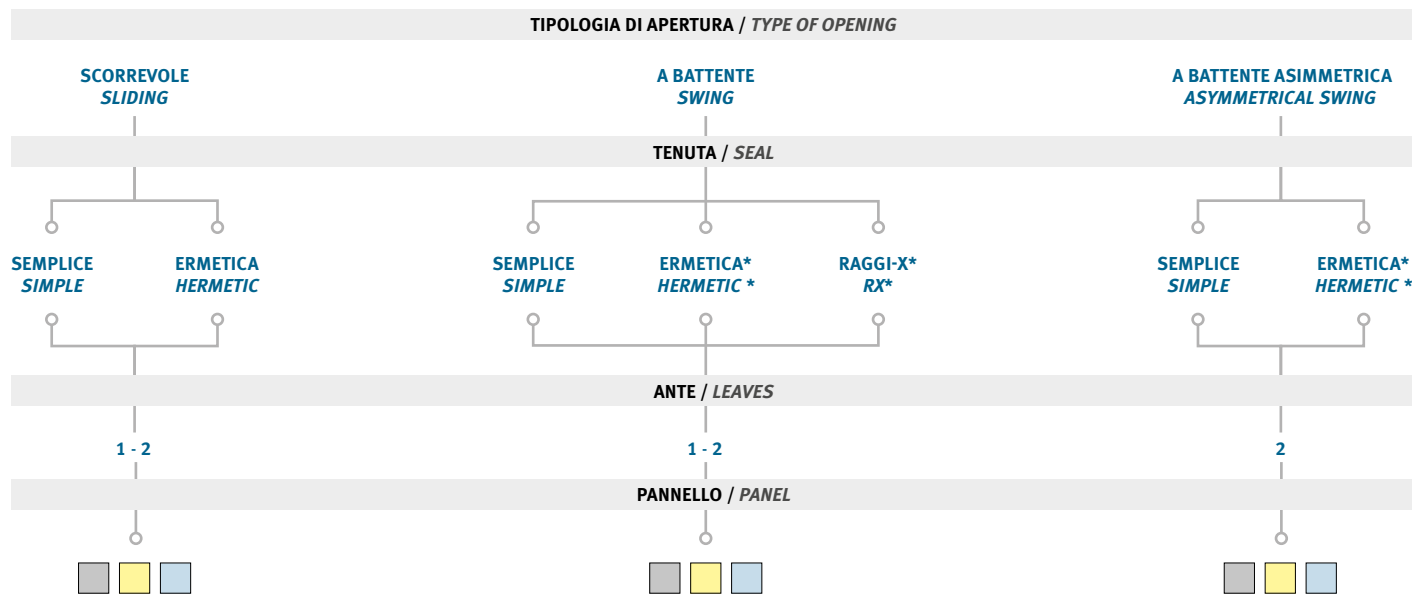

* Per tutti i modelli di porte a battente è disponibile un "Kit tenuta ermetica" dedicato / A special "Hermetic Seal Kit" is available for each of our swing door models.

MODELLI PORTE / DOOR MODELS	TIPOLOGIA / TYPE	MODELLI PORTE / DOOR MODELS	TIPOLOGIA / TYPE
	Automatica A Battente (RX) A Battente Asimmetrica (RX) 1-2 Ante Automatic Swing (RX) Asymmetrical Swing (RX) 1-2 Leaves		ICU/CCU per terapia intensiva con anta scorrevole lineare che scorre su un laterale fisso. - Automatica/Manuale - Scorrevole a tenuta semplice ed ermetica - 1 Anta CU/CCU for intensive care with linear sliding door sliding on a fixed side screen. - Automatic/Manual - Simple and hermetic sliding door - 1 leaf
	Manuale A Battente (RX) A Battente Asimmetrica (RX) 1-2 Ante Manual Swing (RX) Asymmetrical Swing (RX) 1-2 Leaves		ICU/CCU per terapia intensiva con dispositivo TLCA (Total Light Compartment Accessible). - Automatica/Manuale - Scorrevole a tenuta semplice - 1 Anta - Passaggio libero ad ante aperte a 90° con laterale apribile. ICU/CCU for intensive care with TLCA (Total Light Compartment Accessible) device. - Automatic/Manual - Simple sealing sliding door - 1 leaf - Free passage with leaves open at 90° with openable side screen.
	Automatica Telescopica Scorrevole 2 Ante Automatic Telescopic Sliding 2 Leaves		
	Automatica Soffietto 4 Ante (2 dx-2 sx) Automatic Bellows 4 Leaves (2 rh-2 lh)		

NESSUN COMPROMESSO: UN'AMPIA GAMMA DI COMPONENTI PER PERSONALIZZARE LA VOSTRA PORTA

TECNOLOGIA, DESIGN E CONFORMITÀ

I sistemi di porte ospedaliere LABEL sono progettati per essere utilizzati nelle diverse tipologie di strutture ospedaliere e sanitarie. È un sistema modulare che permette di configurare ciascuna porta in base a specifiche caratteristiche tecniche, funzionali ed estetiche.

Le porte Ospedaliere Label sono state sottoposte a vari test prestazionali in Laboratori accreditati e soddisfano i più diffusi standard internazionali.

TECHNOLOGY, DESIGN AND COMPLIANCE

LABEL Hospital Door Systems are designed to be used in different hospital and healthcare facilities.

It is a modular system allowing to configure each door according to specific technical, functional, and aesthetic features.

Label Hospital doors have been subjected to various performance tests in accredited laboratories and meet the most common international standards.



L'IGIENE PRIMA DI TUTTO

I sistemi di porte Label sono progettati per agevolare le operazioni di pulizia e sanificazione.

- I pannelli in laminato o in acciaio possono essere equipaggiati con diverse tipologie di visive la cui complanarità rende in tal modo il prodotto sprovvisto di punti con sedimentazione.
- Le porte in laminato possono essere corredate di fascia paracolpi orizzontale in acciaio.

HYGIENE FIRST AND FOREMOST

Label door systems are designed to facilitate cleaning and sanitation

- *The panels made of HPL or steel can be equipped with different types of flush vision panels which avoid dust settling points.*
- *HPL doors can be fitted with a horizontal steel bump band.*

PER LA TUTELA DELLA PRIVACY

La gamma Label include una serie di soluzioni per agevolare o inibire la visuale all'interno delle stanze in modo semplice ed igienico. Sono indicate per applicazioni nei reparti ICU e CCU, sale operatorie, sale visita.

- I vetri Smart-glass permettono di gestire la privacy della stanza attivando la funzione trasparenza o opacità
- Le tendine elettriche o manuali all'interno delle visive e delle porte vetrate sono una soluzione pratica e igienica per gestire la visibilità all'interno della stanza garantendo il massimo igiene.

FOR THE PROTECTION OF PRIVACY

The Label range includes a series of solutions to facilitate or inhibit the view inside the rooms in a simple and hygienic way. They are suitable for applications in ICUs and CCUs, operating rooms, visit rooms.

- *Smart-glass glazing allows you to manage the privacy of your room by switching the transparency or opacity function*
- *The electric or manual blinds inside the vision panels and glazed doors are a practical and hygienic solution to manage the visibility inside the room, ensuring maximum hygiene.*



NO COMPROMISE: A WIDE RANGE OF COMPONENTS TO CUSTOMIZE YOUR DOOR



TECNOLOGIA SMART

I sistemi di porte Label sono dotati di una vastissima gamma di accessori per il controllo delle porte e per la protezione acustica e da radiazioni

- Per gli ambienti di Radioprotezione i pannelli Label possono essere dotati di piombature di varie dimensioni, rendendo anche il prodotto fonoisolante.
- Per agevolare il transito degli operatori sanitari e del pubblico e per garantire la sicurezza di specifici ambienti sono disponibili un'ampia gamma di accessori quali: maniglie, serrature e varie tipologie di interblocchi.

SMART TECHNOLOGY

Label door systems are equipped with a wide range of accessories for door control, soundproofing, and radiation protection

- for Radioprotection environments, Label panels can be equipped with a variety of lead foils of various sizes, making the product also soundproofing.
- To facilitate the transit of health workers and the public and to guarantee the safety of specific environments, a wide range of accessories is available, such as: handles, locks and various types of interlocks.



L'IMPORTANZA DEL DESIGN

- Stampe digitali, serigrafie, applicazioni di pellicole
- Pannelli in laminato disponibili in 125 colori base o con colore RAL personalizzato.

THE IMPORTANCE OF DESIGN

- Digital printing, screen printing, film applications
- HPL panels available in 125 basic colours or custom RAL colour.



COME LEGGERE I CODICI PARLANTI

I codici delle porte ospedaliere Label sono “parlanti”, ovvero riassumono le specifiche del prodotto per aiutarvi quando effettuate gli ordini. Questo schema vi aiuta a comprendere subito quali sono tutte le caratteristiche di una porta, semplicemente dal suo codice.

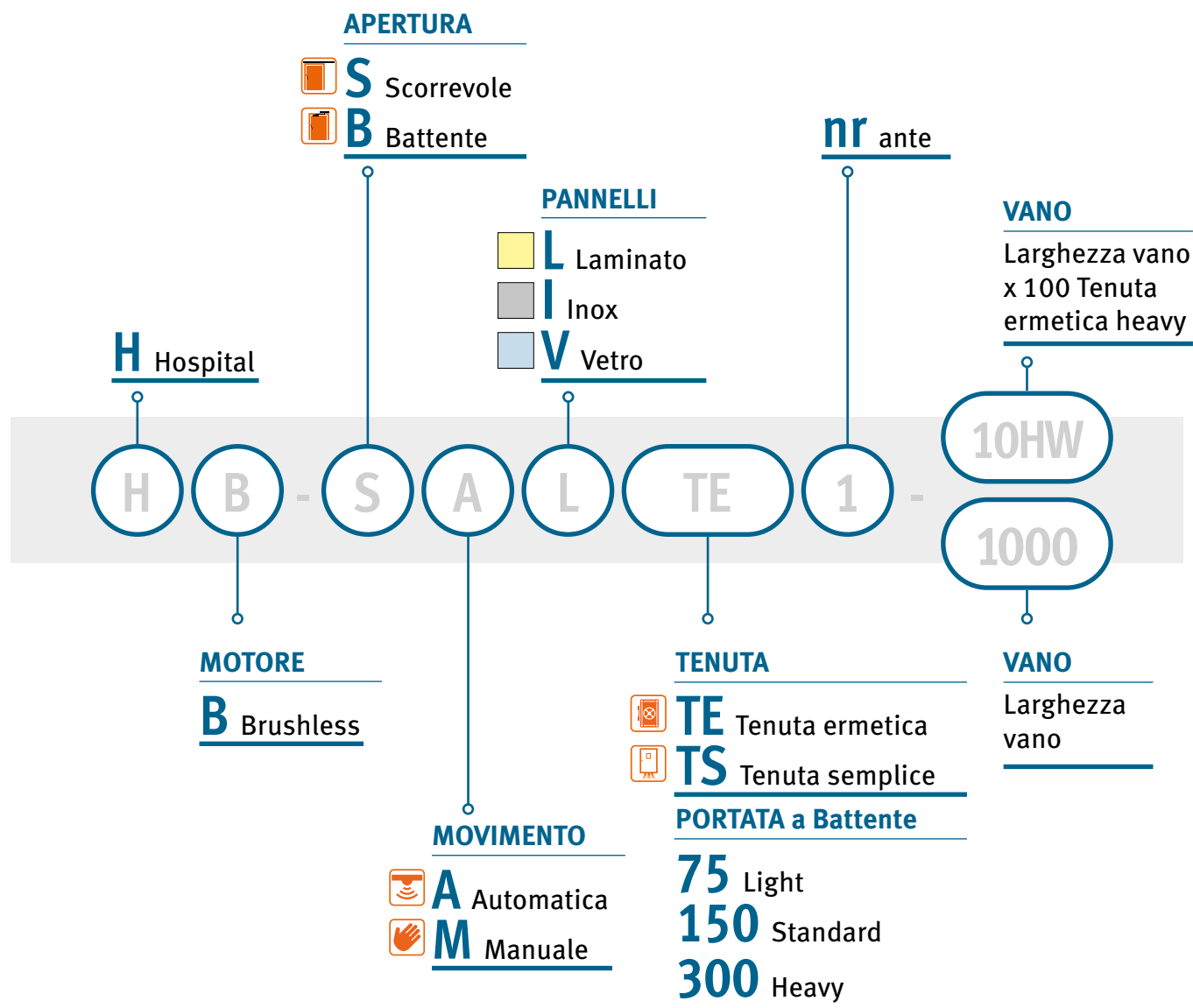

Esempi di lettura dei codici

H-SMLTE1-1900

H Hospital, S Scorrevole, M Manuale, L Laminato, TE Tenuta ermetica, 1 Ante, Vano 1900 mm

HB-B75I1-1000

H Hospital, B Brushless, B Battente, 75 Light, I Inox, 1 Ante, Vano 1000 mm

HOW TO READ MNEMONIC CODES

Label Hospital door codes are mnemonic, summarizing product specifications to help you place orders. This coding helps you understand at a glance the features of a door, simply reading its code.

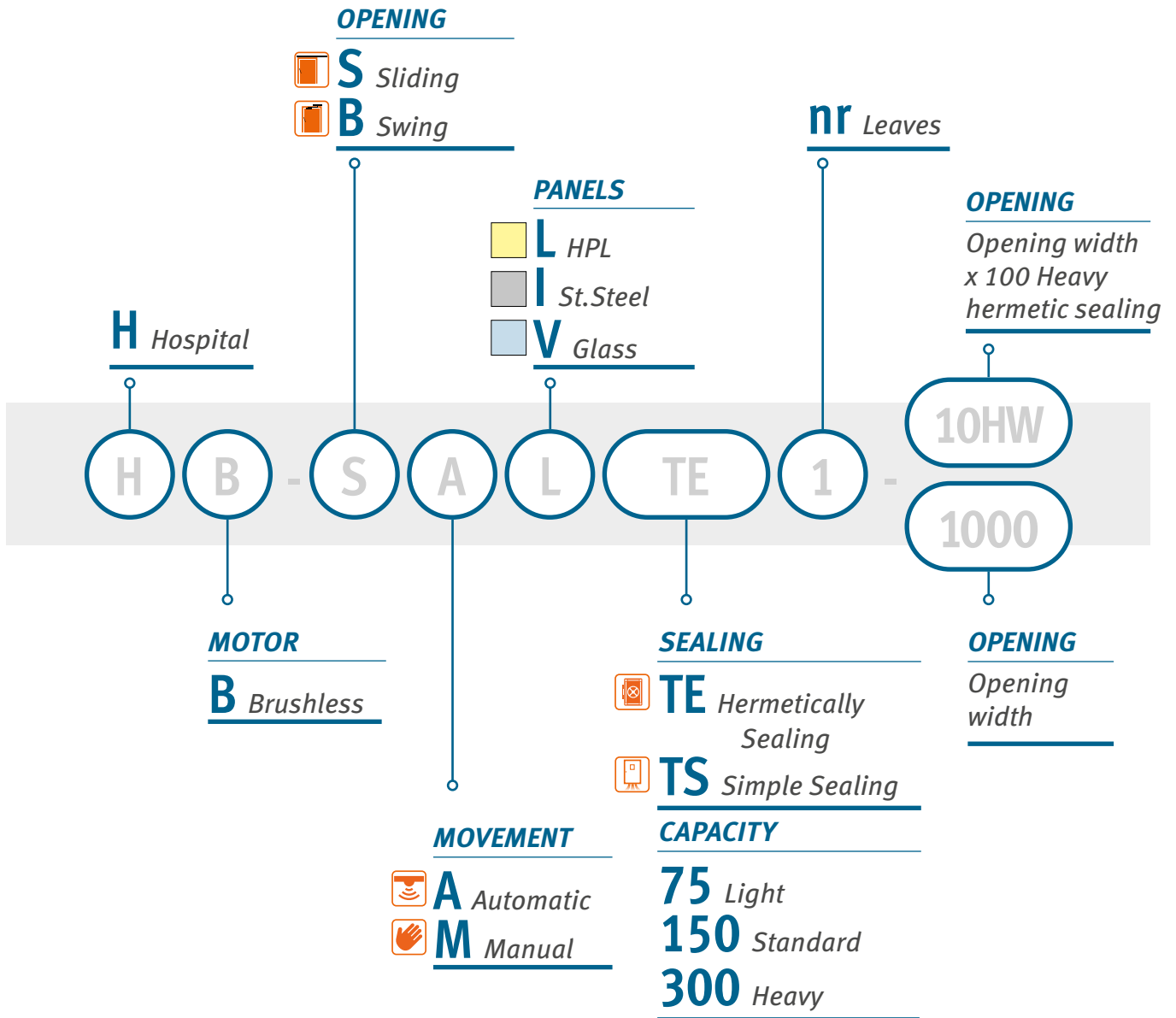

Code examples

H-SMLTE1-1900

H Hospital, **S** Sliding, **M** Manual, **L** HPL, **TE** Hermetically Sealing, **1** Leaf, Opening **1900** mm (74¹³/₁₆"

HB-B75I1-1000

H Hospital, **B** Brushless, **B** Swing, **75** Light, **I** St. Steel, **1** Leaf, Opening **1000** mm (39³/₈"

PORTE IN ACCIAIO INOX E LAMINATO
 ST. STEEL AND HPL DOORS

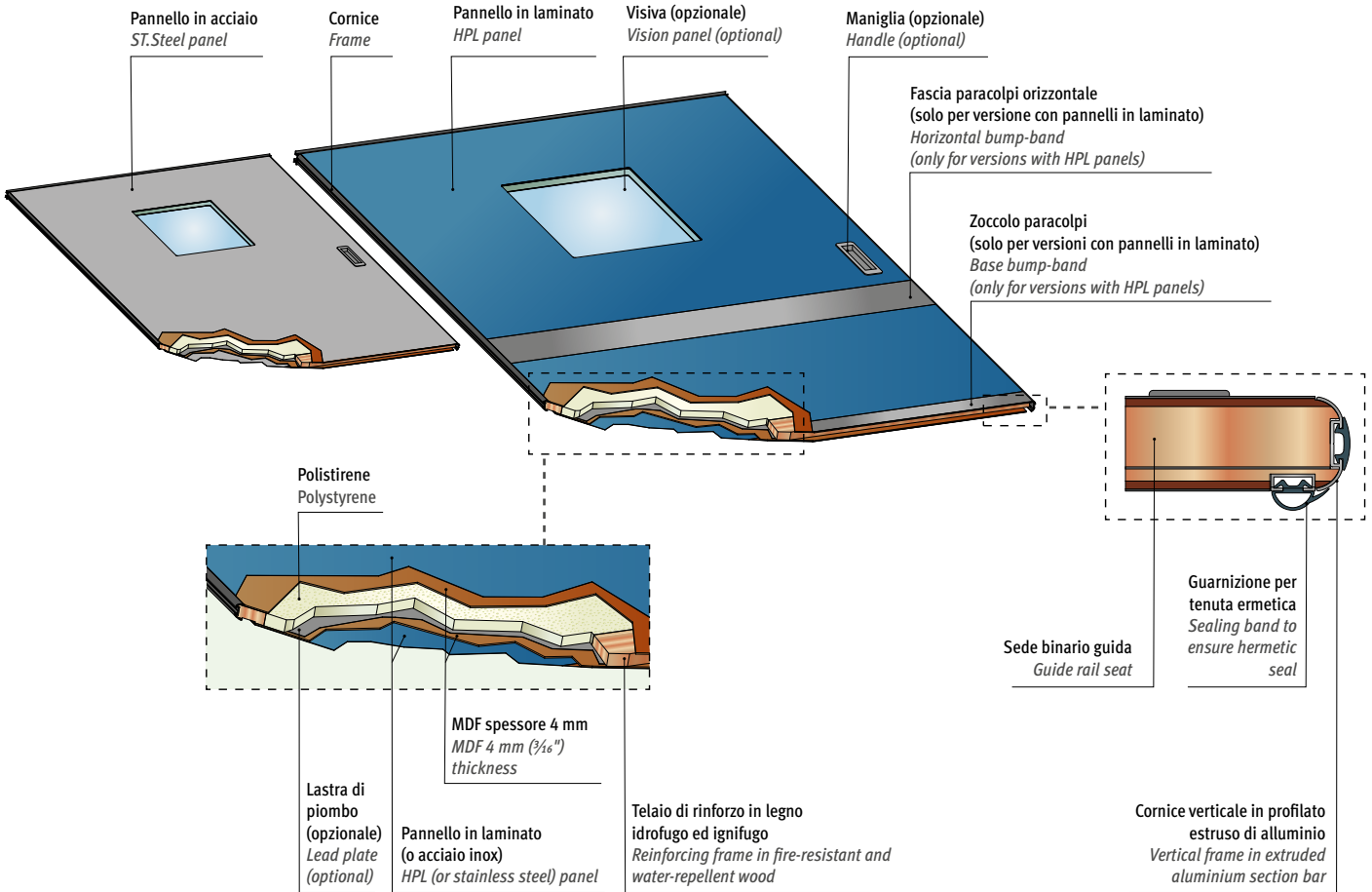

Gamma porte con pannelli in acciaio INOX e LAMINATO

- Porte scorrevoli automatiche a tenuta ermetica
- Porte scorrevoli automatiche a tenuta semplice
- Porte scorrevoli manuali a tenuta ermetica
- Porte scorrevoli manuali a tenuta semplice
- Porte automatiche a battente a tenuta semplice
- Porte automatiche a battente asimmetriche a tenuta semplice
- Porte a battente manuali a tenuta semplice

Componenti di base (inclusi):

- Pannelli (INOX o laminato), completi di profili LB-H in alluminio perfettamente complanari e guarnizioni
- Automazione ETH/E o ETH/T per le porte automatiche scorrevoli NEXT o NEPTIS con braccio per le porte automatiche a battente
- Gruppo copertura in alluminio grezzo
- Programmatore digitale H-DSEL o HB-DSEL, per automazioni con motore brushless
- Sensori di sicurezza (Qt. 2)

Componenti opzionali (da aggiungere all'ordine):

- Dispositivo/i di impulso/attivazione (per le versioni automatiche)
- Maniglia e serratura modello base (per porte manuali) da scegliere nella gamma vedi paragrafo dedicato (pag.108-111) Imbotte oppure Semi-imbotte, in alluminio o acciaio
- Colorazione alluminio gruppo copertura e cornici: scelto fra anodizzato, RAL o effetto INOX
- Batterie e/o maniglie (per versioni automatiche ermetiche)
- Fasce obbligatorie per porte rivestite in laminato con larghezza oltre 1100 mm
- Rivestimento copertura in acciaio INOX
- Fasce alluminio ossidate argento, lamiera zincata/verniciata o in acciaio INOX.
- Lastre piombo da 1, 2, 3 o 4 mm (porte con lastre da 3 mm previa verifica di fattibilità)
- Visive - Visive RX - Visive con tendina
- Dispositivo/i di impulso/attivazione

Stainless steel or HPL panels doors

- Automatic hermetically sealing sliding doors
- Automatic simple sealing sliding doors
- Manual hermetically sealing sliding doors
- Manual simple sealing sliding doors
- Automatic simple sealing swing doors
- Automatic simple sealing asymmetric swing doors
- Manual simple sealing swing doors

Basic components (included)

- Panels (stainless steel or HPL), equipped with perfectly flush LB-H aluminium profiles and sealing bands
- ETH/E or ETH/T automation for automatic sliding doors NEXT or NEPTIS with arm for automatic swing doors
- Cladding unit in mill finish aluminium
- H-DSEL digital programmer or HB-DSEL for brushless motors automations
- Safety sensors (Qty. 2)

Optional components (to be added to the order):

- Pulse/activation device(s) (for automatic versions)
- Basic type handle and lock (for manual doors) to be chosen in the range, see special paragraph (pages 108-111)
- Wall frame or Semi-wall frame, in aluminium or steel
- Colour of aluminium cladding unit and frames: choice of anodized, RAL or stainless-steel effect
- Batteries and/or handles (for automatic hermetic versions)
- Compulsory bands for HPL-coated doors over 1100 mm (47 $\frac{1}{4}$ " in width)
- Cover coating in stainless steel
- Bands in aluminium with silver oxidization, galvanized/painted plate, or stainless steel.
- Lead plate 1, 2, 3 ($\frac{1}{16}$ ", $\frac{1}{8}$ ") or 4 mm ($\frac{3}{16}$ "), thick (doors with 3 mm ($\frac{1}{8}$ ") plates are subject to feasibility analysis)
- Vision panels - Vision panels in X-ray glass
- Pulse/activation device(s)



PORTE VETRATE
 GLAZED DOORS

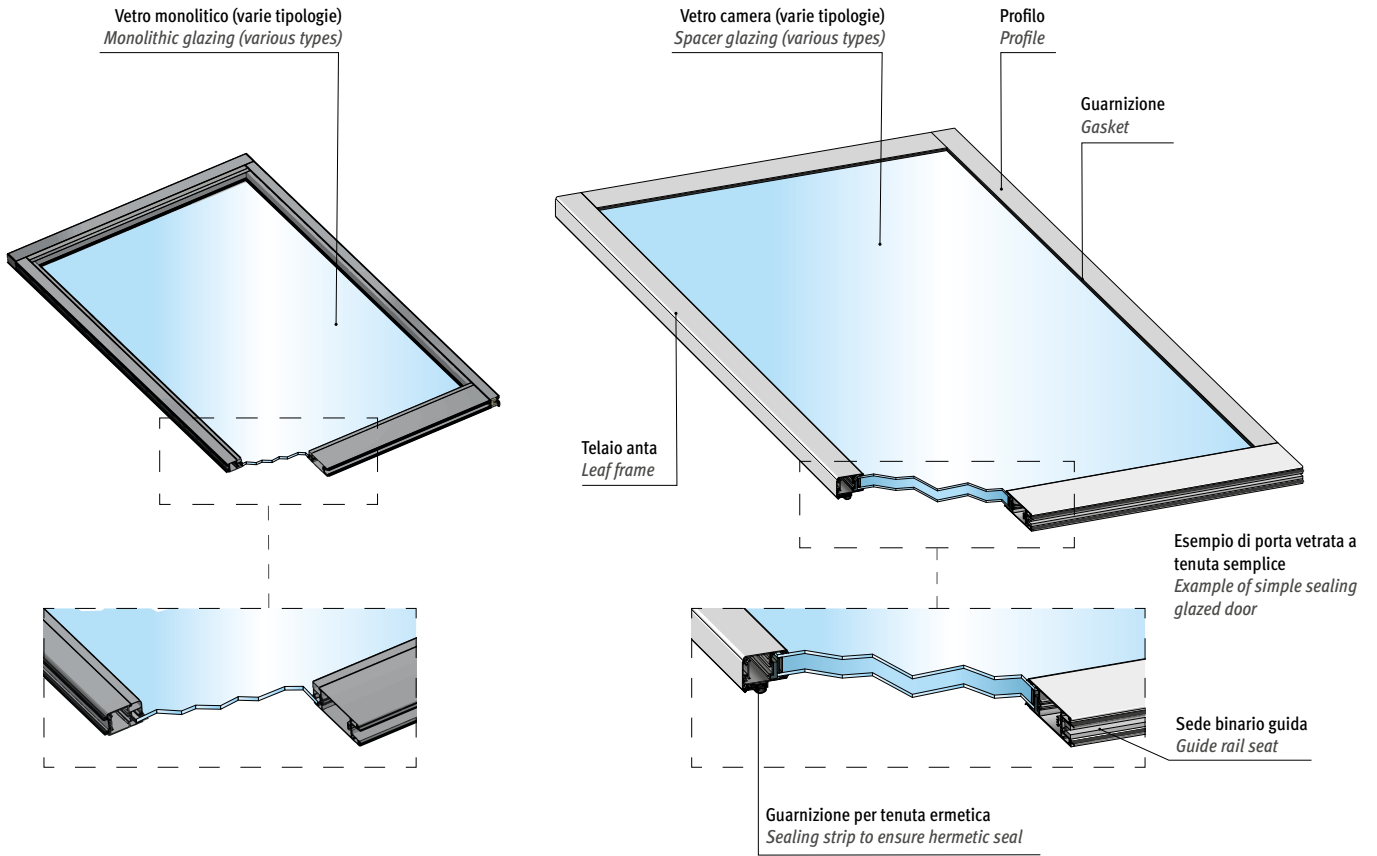

Gamma porte con vetrata

- Porte vetrate ad alta visibilità per ICU e degenza
- Porte scorrevoli automatiche vetrate a tenuta ermetica
- Porte scorrevoli automatiche vetrate a tenuta semplice
- Porte scorrevoli manuali vetrate a tenuta ermetica
- Porte scorrevoli manuali vetrate a tenuta semplice
- Porte a battente automatiche vetrate a tenuta semplice
- Porte a battente automatiche asimmetriche a tenuta semplice
- Porte a battente manuali vetrate a tenuta semplice

Componenti di base (inclusi):

- Telaio di alluminio con vetro stratificato trasparente spessore 44.2 e guarnizioni.
- Automazione ETH/E o ETH per le porte automatiche scorrevoli NEXT o NEPTIS con braccio per le porte automatiche a battente
- Gruppo copertura in alluminio grezzo
- Programmatore digitale H-DSEL o HB-DSEL per automazioni con motore brushless.
- Sensori di sicurezza (Qt. 2)

Componenti opzionali (da aggiungere all'ordine):

- Dispositivo/i di impulso/attivazione (per le versioni automatiche)
- Maniglia e serratura modello base (per porte manuali) da scegliere nella gamma vedi paragrafo dedicato (pag.108-111)
- Imbotte oppure semi-imbotte, in alluminio o acciaio
- Colorazione alluminio gruppo copertura e profili: scelto fra anodizzato, RAL o effetto INOX
- Batterie e/o maniglie (per versioni automatiche ermetiche)
- Rivestimento copertura in acciaio INOX
- Fasce alluminio colorazione su richiesta
- Vetrazioni varie
- Tendine elettriche e manuali

Glazed doors

- *High visibility glazed doors for ICU and ward*
- *Automatic hermetically sealing glazed sliding doors*
- *Automatic simple sealing glazed sliding doors*
- *Manual hermetically sealing glazed sliding doors*
- *Manual simple sealing glazed sliding doors*
- *Automatic simple sealing glazed swing doors*
- *Automatic simple sealing asymmetric swing doors*
- *Manual simple sealing glazed swing doors*

Basic components (included):

- *Transparent aluminium and laminated glass frame, thickness 44.2 or 8 mm (5/8") and gaskets.*
- *ETH/E or ETH automation for automatic sliding doors or NEPTIS automation with arm for automatic swing doors*
- *Raw aluminium covering unit*
- *Digital selector H-DSEL or HB-DSEL for automations with brushless motor.*
- *Safety sensors (Qty. 2)*

Optional components (to be added to the order):

- *Pulse/activation device(s) (for automatic versions)*
- *Basic type handle and lock (for manual doors) to be chosen in the range, see special paragraph (pages 108-111)*
- *Wall frame or semi-wall frame, in aluminium or steel*
- *Colour of aluminium cladding unit and profiles: choice of anodized, RAL or stainless-steel effect*
- *Batteries and/or handles (for automatic hermetic versions)*
- *Cover coating in stainless steel*
- *Bands in painted aluminium upon request*
- *Miscellaneous glazings*
- *Manual and electric curtains*





PORTE
SCORREVOLI

SLIDING DOORS

I prodotti Label si distinguono per l'eleganza delle forme, la qualità dei materiali e la semplicità di installazione.

Le automazioni e gli ingressi Label vengono costruiti interamente in Italia da personale altamente specializzato e ogni prodotto supera un severo controllo qualità.

La gamma di porte scorrevoli ospedaliere è in grado di soddisfare le esigenze dei diversi reparti ospedalieri e dei luoghi di cura.

Sia che scegliate una soluzione con apertura automatica o manuale, potete personalizzare la vostra porta scegliendo fra una vasta gamma di finiture e accessori per arrivare ad ottenere un "sistema porta" completo e che si armonizza perfettamente con il design dell'edificio garantendo allo stesso tempo il massimo dell'efficienza e dell'affidabilità.

Label products are characterized by the elegance of their design, the quality of their materials, and the simplicity of installation.

Label automations and entrances are built entirely in Italy by highly specialized personnel. Each product undergoes strict quality controls.

The range of hospital sliding doors can meet the needs of different hospital departments and care facilities.

Whether you choose a solution with automatic or manual opening, you can customize your door by choosing from a wide range of finishes and accessories to obtain a complete "door system" that perfectly matches the design of the building while ensuring maximum efficiency and reliability.

Operatore conforme alle norme europee

Automation in compliance with European standards

EN 16005; EN 13849-1; EN 13849 -2; EN 61000-6-2; EN 61000-6-3;
EN 60335-2-103; DIN 18650-1; DIN 18650-2



LEGENDA PITTOGRAMMI TABELLE - TABLES PICTOGRAMS LEGEND

	Codice Code		Descrizione Description		Spessore muro Wall thickness		Confezione Package
	Funzionamento Automatico Automatic operation		Funzionamento Manuale Manual operation		Tenuta Ermetica Hermetic seal		Tenuta Semplice Simple seal
	Battente Swing		Anta Leaf		Scorrevole Sliding		Finitura Finish

LEGENDA PREZZI

I prezzi sono espressi in € e indicano il prezzo unitario o il prezzo al metro

Esempio: 5,00 = (prezzo unitario)
Esempio: 5,00/m = (prezzo al metro)

PRICES LEGEND

Prices are in € and indicate the unit price or the price per meter







Example: 5,00 = (unit price)
Example: 5,00/m = (price per meter)

PORTE SCORREVOLI AUTOMATICHE A TENUTA ERMETICA

La porta (spessore 47 mm) si muove orizzontalmente e, in prossimità della chiusura, gestisce automaticamente il movimento di abbassamento e traslazione della porta affinché questa si avvicini sia al muro che al pavimento, garantendo così la tenuta ermetica, mediante la compressione di speciali guarnizioni in gomma presenti sui quattro lati della porta.

I tre carrelli di sostegno possono supportare e spostare un'anta di 150 kg nella versione ETH/E, mentre nella versione ETH/E-HW sono presenti quattro carrelli in grado di movimentare un'anta di 250 Kg.

L'automazione è dotata di un software specifico per la gestione delle fasi di abbassamento e di traslazione durante la chiusura della porta e del controllo di potenza e velocità durante l'apertura.







Pannelli	Inclusi
	Automazione ETH/E (ETH/E-HW) con motore brushless: <ul style="list-style-type: none"> • Automazione su trave in lega di alluminio da 125 mm e fianchetti laterali in ABS • Gruppo copertura ispezionabile da mm 135(p) x180(h) in lega di alluminio • Fissaggio su struttura portante con rotaia di scorrimento in lega di alluminio sospesa su guida antirumore in polizene • Motore Brushless 24Vdc con encoder incorporato. • Trasmissione del movimento mediante cinghia dentata in gomma con cordoli in kevlar, antistatica • Tre carrelli di sostegno anta con dispositivo antideragliamento per modello ETH/E (fino a 150Kg) • Quattro carrelli di sostegno anta con dispositivo antideragliamento per modello ETH/E-HW (fino a 250Kg) • Unità di controllo con microprocessore ad autoapprendimento e gestione automatica delle procedure di sicurezza (anti-schiacciamento, inversione di direzione, movimento di sicurezza a bassa velocità)
	Pannello anta completo di cornici e guarnizioni dedicate
	Anta completa di profili, vetro 44.2 e guarnizioni dedicate
	Gruppo copertura in alluminio nella versione con finitura grezza
	Programmatore digitale
	Sensori di sicurezza (Qt.2)

AUTOMATIC HERMETICALLY SEALING SLIDING DOORS

The door (thickness 47 mm - 1 7/8") moves horizontally and, when nearly closed, automatically manages its lowering and translation towards both the wall and the floor, thereby guaranteeing a hermetic seal through the compression of special rubber sealing strips on the four sides of the door.

The three support trolleys can support and move a 150 kg (330lb) leaf in the ETH/E version, while in the ETH/E-HW version there are four trolleys capable of moving a 250 kg (551lb) leaf.

The automation is equipped with a special software to manage lowering and translation during door closing, and power and speed control during opening.

Panels	Includes
	ETH/E (ETH/E-HW) automation with brushless motor: <ul style="list-style-type: none"> • Automation on 125 mm (4 7/8") transom made of aluminium alloy and side caps in ABS • Mm 135 - 5 5/16" (d) x 180 - 7 1/16" (h) aluminium alloy inspection cover assembly • Fastened on a load-bearing structure with an aluminium alloy slideway rail mounted on a sound-dampening polyzene guide. • Brushless 24Vdc motor with built-in encoder • The movement is driven by a rubber antistatic timing belt with Kevlar sides. • Three leaf support trolleys with anti-derailment device for ETH/E model (up to 150kg - 330lb) • Four leaf support trolleys with anti-derailment device for ETH/E-HW model (up to 250kg - 551lb) • Control unit with self-learning microprocessor and automatic management of safety procedures (anti-crushing, direction reversal, low-speed safety movement)
	Leaf panel complete with dedicated frames and gaskets
	Leaf complete with profiles, 44.2 or 8 mm (5/16") glazing, and dedicated gaskets
	Aluminium covering unit in the raw-aluminium version
	Digital selector
	Safety sensors (Qty. 2)



 Acciaio / ST.Steel  Laminato / HPL  Vetro / Glass

PORTE SCORREVOLI AUTOMATICHE A TENUTA ERMETICA AUTOMATIC HERMETICALLY SEALING SLIDING DOORS

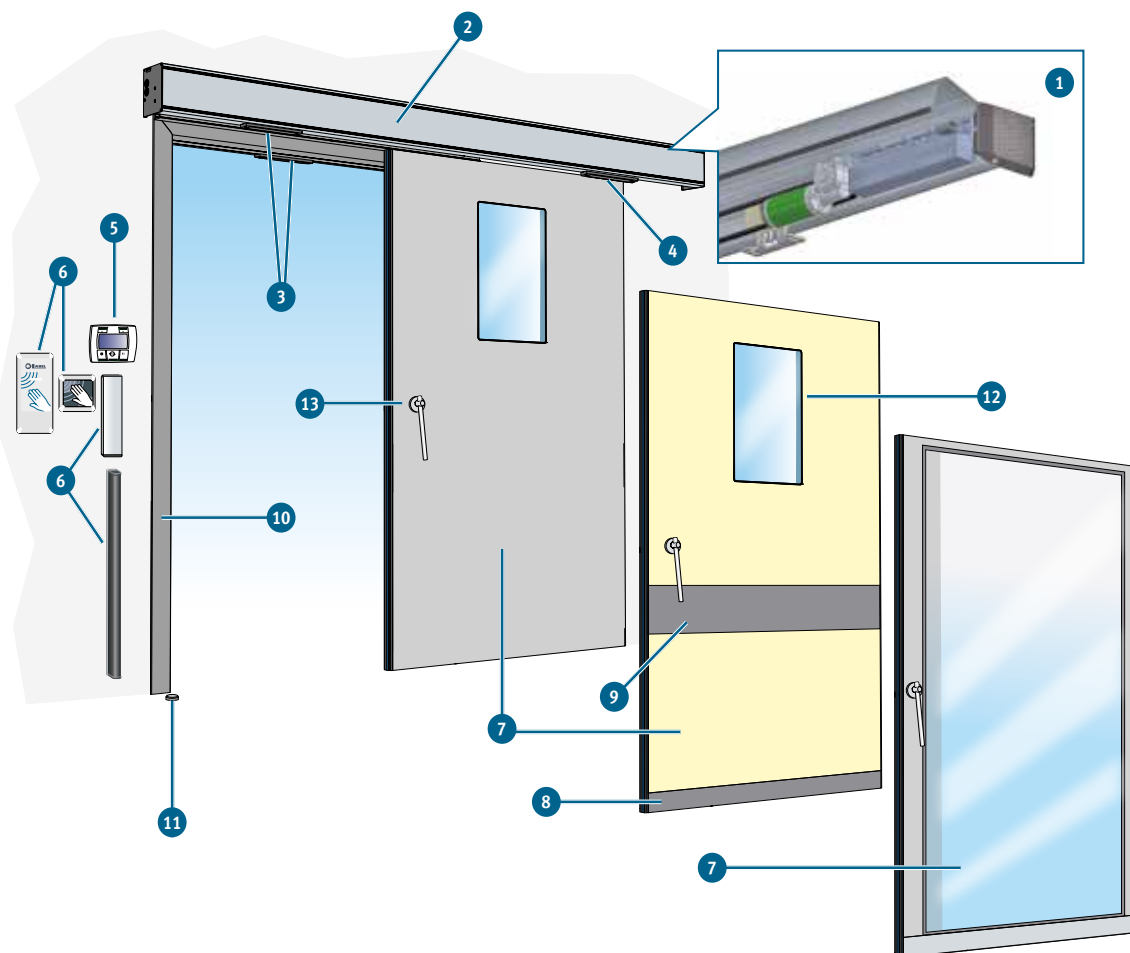

Legenda / Key

1 Gruppo automazione / Automation unit

2 Gruppo copertura / Cladding unit

3 Sensore di sicurezza in chiusura / Closing safety sensor

4 Sensore di sicurezza in apertura opzionale / Optional opening safety sensor

5 Programmatore digitale / Digital programmer

6 Dispositivi di attivazione / Activation devices

7 Pannello / Panel

8 Zoccolo / Base

9 Fascia orizzontale / Horizontal band

10 Imbotte (o semi-imbotte) opzionale
Optional wall frame (or semi-wall frame)

11 Riscontro in chiusura / Closing striker

12 Visiva (opzionale) / Vision panel (optional)

13 Maniglia (opzionale) / Handle (optional)



- Prova di permeabilità all'aria n° 278814
- Misurazione isolamento acustico in laboratorio n° 315233

- ETH-E Air permeability test no. 278814
- Laboratory measurement of sound insulation no. 315233



Porta scorrevole automatica a tenuta ermetica - 1 anta
Automatic hermetically sealing sliding door - 1 leaf

AUTOMAZIONE ETH/E ETH/E AUTOMATION	HB-SAITE1	HB-SALTE1	HB-SAVTE1
	PANNELLO INOX STAINLESS STEEL PANEL	PANNELLO LAMINATO HPL PANEL	PANNELLO VETRO GLASS PANEL
LARGHEZZA VANO FINO A (LV) OPENING WIDTH UP TO (LV)			
800 mm (31½")	HB-SAITE1-800	HB-SALTE1-800	HB-SAVTE1-800
900 mm (35¼")	HB-SAITE1-900	HB-SALTE1-900	HB-SAVTE1-900
1000 mm (39¾")	HB-SAITE1-1000	HB-SALTE1-1000	HB-SAVTE1-1000
1100 mm (43⅝")	HB-SAITE1-1100	HB-SALTE1-1100	HB-SAVTE1-1100
1200 mm (47¼")	HB-SAITE1-1200	HB-SALTE1-1200	HB-SAVTE1-1200
1300 mm (51¼")	HB-SAITE1-1300	HB-SALTE1-1300	HB-SAVTE1-1300
1400 mm (55⅝")	HB-SAITE1-1400	HB-SALTE1-1400	HB-SAVTE1-1400
1500 mm (59⅝")	HB-SAITE1-1500	HB-SALTE1-1500	HB-SAVTE1-1500
1600 mm (63")	HB-SAITE1-1600	HB-SALTE1-1600	HB-SAVTE1-1600
1700 mm (66⅝")	HB-SAITE1-1700	HB-SALTE1-1700	HB-SAVTE1-1700
1800 mm (70¾")	HB-SAITE1-1800	HB-SALTE1-1800	HB-SAVTE1-1800
1900 mm (74⅜")	HB-SAITE1-1900*	HB-SALTE1-1900	HB-SAVTE1-1900
2000 mm (78¾")	HB-SAITE1-2000*	HB-SALTE1-2000	HB-SAVTE1-2000

* Rivestimento in lamiera INOX con giunzione verticale | *Stainless steel cladding with vertical junction*

Elementi Opzionali da ordinare separatamente al momento dell'ordine
Optional items to be ordered separately at time of order

Colorazioni e finiture speciali Special colours and finishes	Fasce / Bands	Rivestimenti gruppo copertura Covering unit cladding	Visiva / Vision panel	Tendine elettriche e manuali Manual and electric blinds	Piombature Lead foils
pag./page 120	pag./page 103	pag./page 102	pag./page 96	pag./page 96	pag./page 104
Maniglie e maniglioni per porte scorrevoli Handle for Sliding Door	Maniglie per porte manuali a battente Level handle for manual swing door	Serrature Mechanical Lock	Dispositivi di impulso (se diversi da quelli standard) Pulse devices (if other than the standard ones)	Batterie di apertura in emergenza Emergency opening batteries	Imbotti e semi-imbotti Wall frame and semi-wall frame
pag./page 108	pag./page 109	pag./page 110	pag./page 117	pag./page 118	pag./page 100

■ Acciaio / ST.Steel ■ Laminato / HPL ■ Vetro / Glass

■ HB-SAITE1 ■ HB-SALTE1

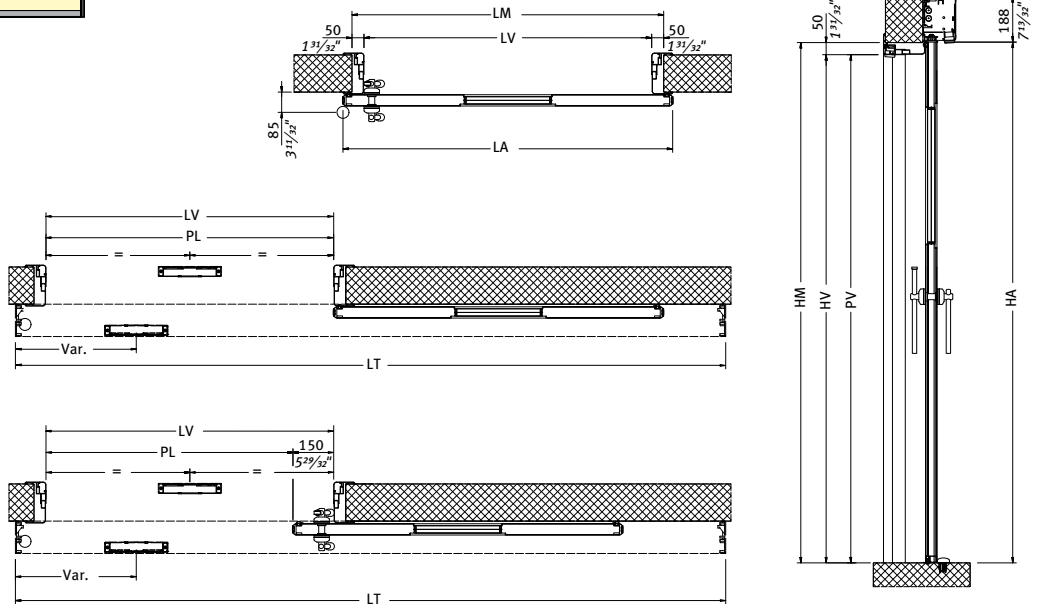
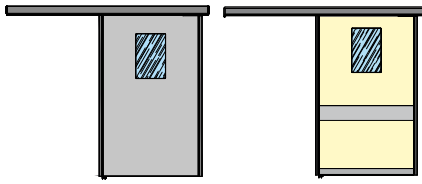

■ HB-SAVTE1

Aperto / Open Chiuso / Closed

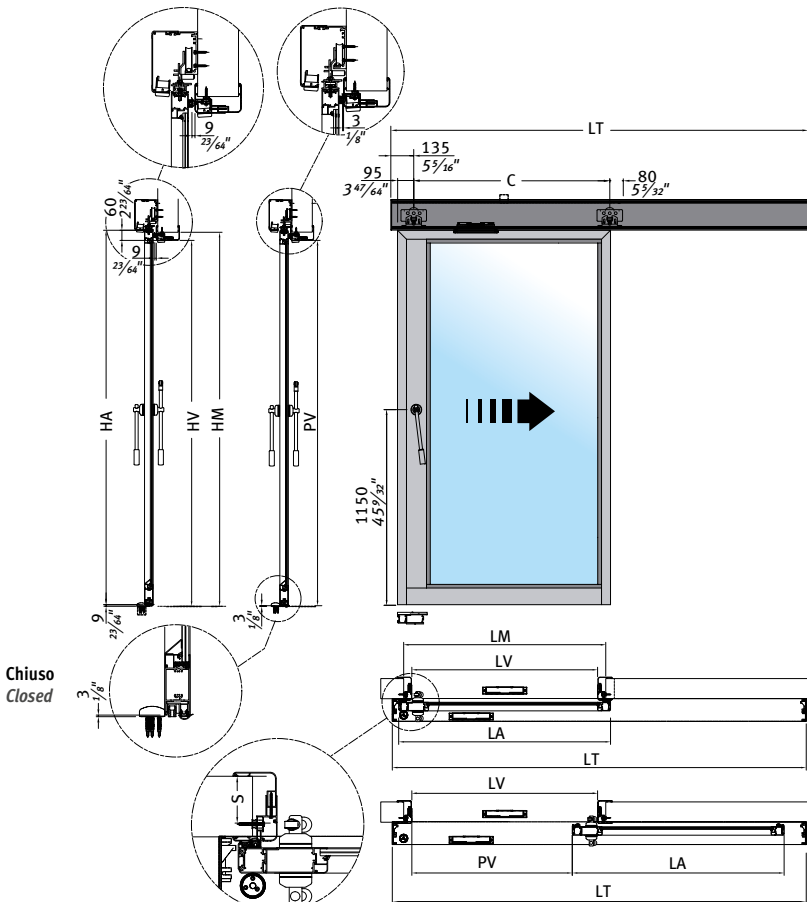

■ ■ ■ **Legenda / Key**

PL	Passaggio netto orizzontale Horizontal net passage
PV	Passaggio netto verticale Vertical net passage
LT	Lunghezza automazione Automation length
S	Spessore muro Wall thickness
LM	Larghezza vano grezzo Unfinished opening width
LV	Larghezza vano finito Finished opening width
LA	Larghezza anta Leaf width
HM	Altezza vano grezzo Unfinished opening height
HV	Altezza vano finito Finished opening height
HA	Altezza anta Leaf height

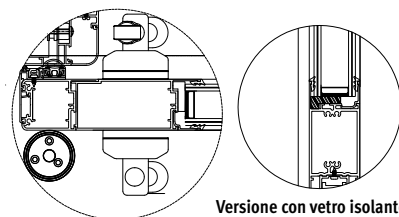

Versione con vetro isolante
Version with insulating glass



Porta scorrevole automatica a tenuta ermetica HW - 1 anta
Automatic hermetically sealing sliding doors HW - 1 leaf

AUTOMAZIONE ETH-E/HW <i>ETH-E/HW AUTOMATION</i>	HB-SAITE1-HW	HB-SALTE1-HW	HB-SAVTE1-HW
	PANNELLO INOX <i>STAINLESS STEEL PANEL</i>	PANNELLO LAMINATO <i>HPL PANEL</i>	PANNELLO VETRO <i>GLASS PANEL</i>
LARGHEZZA VANO FINO A (LV) <i>OPENING WIDTH UP TO (LV)</i>			
1000 mm (39 ³ / ₈ "	HB-SAITE1-10HW	HB-SALTE1-10HW	HB-SAVTE1-10HW
1200 mm (47 ¹ / ₄ "	HB-SAITE1-12HW	HB-SALTE1-12HW	HB-SAVTE1-12HW
1400 mm (55 ¹ / ₈ "	HB-SAITE1-14HW	HB-SALTE1-14HW	HB-SAVTE1-14HW
1600 mm (63")	HB-SAITE1-16HW	HB-SALTE1-16HW	HB-SAVTE1-16HW
1800 mm (70 ³ / ₈ "	HB-SAITE1-18HW*	HB-SALTE1-18HW	HB-SAVTE1-18HW
2000 mm (78 ³ / ₄ "	HB-SAITE1-20HW*	HB-SALTE1-20HW	HB-SAVTE1-20HW

* Rivestimento in lamiera inox con giunzione verticale
* *Stainless steel cladding with vertical junction*

Elementi Opzionali da ordinare separatamente al momento dell'ordine
Optional items to be ordered separately at time of order

Colorazioni e finiture speciali <i>Special colours and finishes</i>	Fasce / Bands	Rivestimenti gruppo copertura <i>Covering unit cladding</i>	Visiva / Vision panel	Tendine elettriche e manuali <i>Manual and electric blinds</i>	Piombature <i>Lead foils</i>
pag./page 120	pag./page 103	pag./page 102	pag./page 96	pag./page 96	pag./page 104
Maniglie e maniglioni per porte scorrevoli <i>Handle for Sliding Door</i>	Maniglie per porte manuali a battente <i>Level handle for manual swing door</i>	Serrature <i>Mechanical Lock</i>	Dispositivi di impulso (se diversi da quelli standard) <i>Pulse devices (if other than the standard ones)</i>	Batterie di apertura in emergenza <i>Emergency opening batteries</i>	Imbotti e semi-imbotti <i>Wall frame and semi-wall frame</i>
pag./page 108	pag./page 109	pag./page 110	pag./page 117	pag./page 118	pag./page 100

■ Acciaio / ST.Steel ■ Laminato / HPL ■ Vetro / Glass

■ HB-SAITE1-HW ■ HB-SALTE1-HW

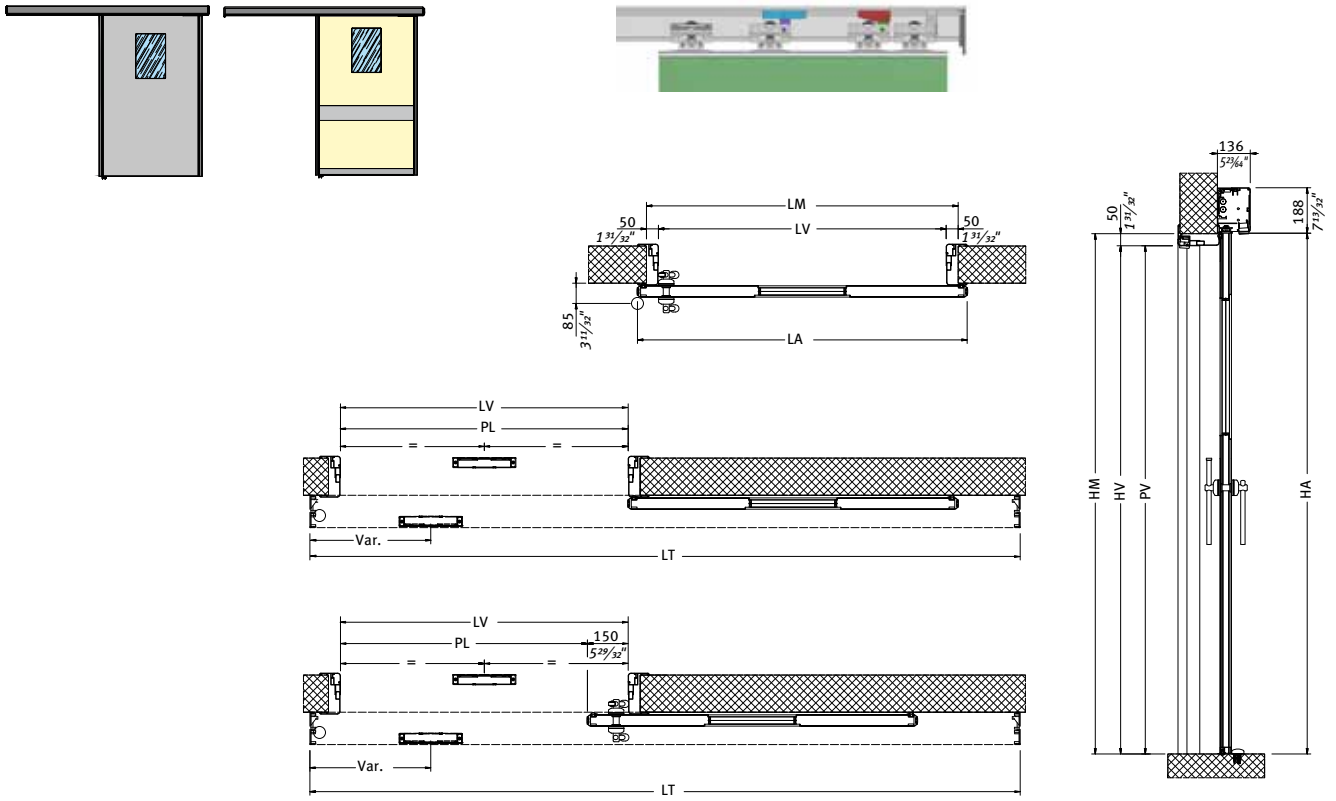

■ HB-SAVTE1-HW

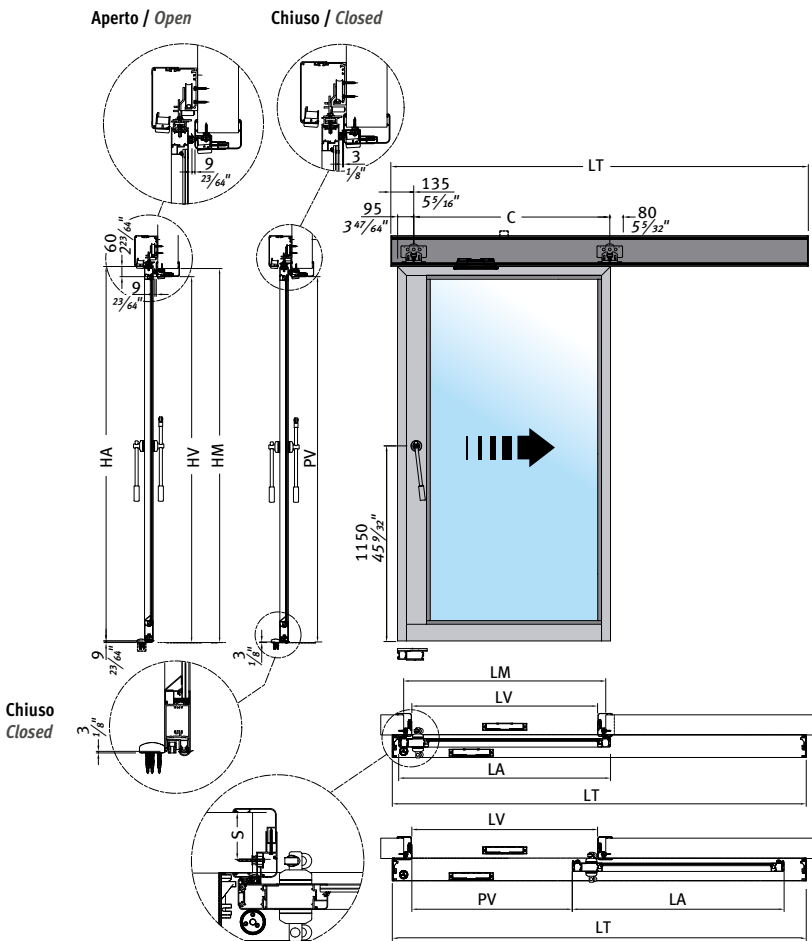

■ ■ ■ **Legenda / Key**

PL	Passaggio netto orizzontale <i>Horizontal net passage</i>
PV	Passaggio netto verticale <i>Vertical net passage</i>
LT	Lunghezza automazione <i>Automation length</i>
S	Spessore muro <i>Wall thickness</i>
LM	Larghezza vano grezzo <i>Unfinished opening width</i>
LV	Larghezza vano finito <i>Finished opening width</i>
LA	Larghezza anta <i>Leaf width</i>
HM	Altezza vano grezzo <i>Unfinished opening height</i>
HV	Altezza vano finito <i>Finished opening height</i>
HA	Altezza anta <i>Leaf height</i>

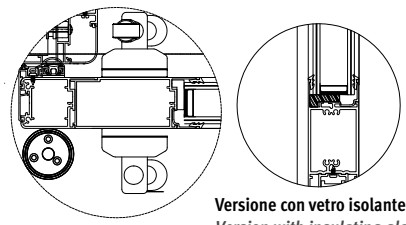







Versione con vetro isolante
Version with insulating glass

PORTE SCORREVOLI AUTOMATICHE A TENUTA SEMPLICE

La porta si muove orizzontalmente e, in prossimità della chiusura, va in appoggio sui montanti ed il traverso del telaio sporgente a muro garantendo, mediante la compressione di speciali guarnizioni in gomma presenti sui due lati verticali e sul lato orizzontale superiore della porta, la tenuta all'aria.







I carrelli di sostegno possono supportare e spostare un carico massimo di 300 kg per porta ad anta singola. L'automazione è inoltre dotata di specifico software in grado di fornire potenza aggiuntiva nella movimentazione di porte pesanti.

Pannelli	Inclusi
	Automazione ETH con motore BRUSHLESS: <ul style="list-style-type: none"> • Automazione su trave da 78 mm, copertura ispezionabile in alluminio e fianchetti laterali in ABS • Gruppo copertura da mm 150x120H in lega di alluminio con articolazione per sgancio e supporto • Automazione per una o due ante scorrevoli • Portata massima di 400 kg per porta a doppia anta o 300 kg per porta ad anta singola • Lunghezza massima dell'automazione: 6500 mm • Rotaia di scorrimento in lega di alluminio sospesa su guarnizione in gomma anti-rumore • Motore BRUSHLESS, scatola ingranaggi reversibile • Trasmissione del movimento mediante cinghia dentata in gomma con cordoli in kevlar, antistatica • Carrelli a doppia ruota con dispositivo anti-deragliamento • Unità di controllo con microprocessore ad auto-apprendimento e gestione automatica delle procedure di sicurezza (anti-schiacciamento, inversione di direzione, movimento di sicurezza a bassa velocità)
	Pannello anta completo di cornici e guarnizioni dedicate
	Anta completa di profili, vetro 44.2 e guarnizioni dedicate
	Gruppo copertura in alluminio nella versione con finitura grezza
	Programmatore digitale
	Sensori di sicurezza (Qt.2)

AUTOMATIC SIMPLE SEALING SLIDING DOORS

The door moves horizontally and, when it is nearly closed, it comes to rest against the uprights and the crossbar of the frame, which extends out from the wall, ensuring, by means of the compression of special rubber gaskets on the two vertical sides and the top horizontal side of the door, an airtight seal.

The support trolleys can bear and convey a maximum load of 300 kg (661lb) per single-leaf door. The automation is also equipped with a specific type of software that is able to provide additional power when operating heavy doors.

Panels	Includes
	ETH automation with BRUSHLESS motor: <ul style="list-style-type: none"> • Automation on 78 mm (3 1/16") transom, aluminium cover accessible for inspection, ABS side caps • Aluminium alloy covering unit, 150 x 120 H mm (5 15/16" x 4 3/4" H), with release and support articulation • Automation for one or two sliding leaves • Maximum load capacity of 400 kg (881lb) for a double-leaf door or 300 kg (661lb) for a single-leaf door • Maximum automation length: 6500 (255 15/16") mm • Aluminium alloy slideway rail mounted on a sound-dampening rubber gasket • BRUSHLESS motor, reversible gearbox • The movement is transmitted by a rubber antistatic timing belt with Kevlar sides • Double-wheel trolleys with anti-derailment device • Control unit with self-learning microprocessor and automatic management of safety procedures (anti-crushing, direction reversal, low-speed safety movement)
	Leaf panel complete with dedicated frames and gaskets
	Leaf complete with profiles, 44.2 or 8 mm (5/16") glazing, and dedicated gaskets
	Raw aluminium covering unit
	Digital selector
	Safety sensors (Qty. 2)



 Acciaio / ST.Steel  Laminato / HPL  Vetro / Glass

PORTE SCORREVOLI AUTOMATICHE A TENUTA SEMPLICE AUTOMATIC SIMPLE SEALING SLIDING DOORS

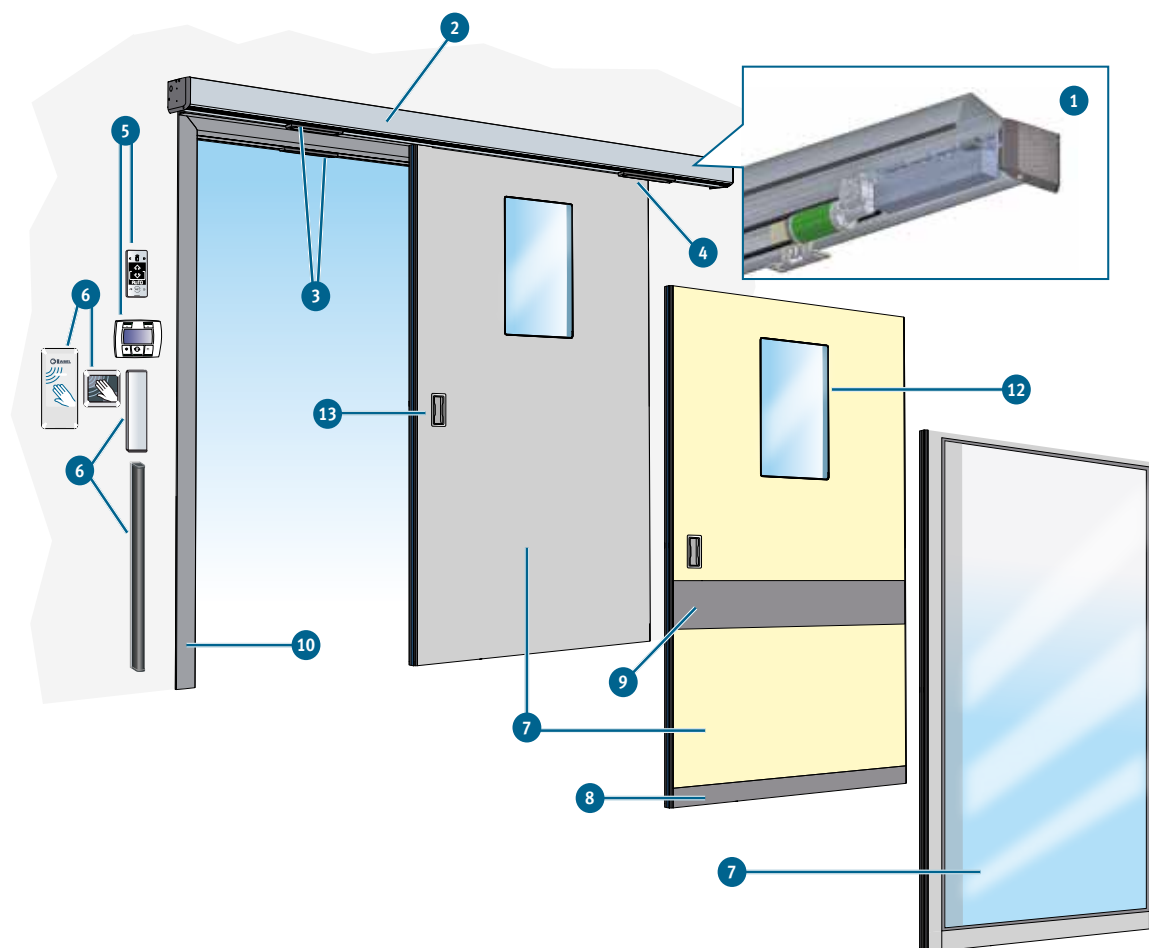

Legenda / Key

- | | |
|---|--|
| 1 Gruppo automazione / Automation unit | 7 Pannello / Panel |
| 2 Gruppo copertura / Cladding unit | 8 Zoccolo / Base |
| 3 Sensore di sicurezza in chiusura / Closing safety sensor | 9 Fascia orizzontale / Horizontal band |
| 4 Sensore di sicurezza in apertura opzionale / Optional opening safety sensor | 10 Imbotte (o semi-imbotte) opzionale / Optional wall frame (or semi-wall frame) |
| 5 Programmatore digitale / Digital programmer | 12 Visiva (opzionale) / Vision panel (optional) |
| 6 Dispositivi di attivazione / Activation devices | 13 Maniglia (opzionale) / Handle (optional) |



Misurazione in laboratorio isolamento acustico n° 315230
(misurazione isolamento acustico sui pannelli effettuata con metodo empirico).

Laboratory measurement of sound insulation no. 315230
(measurement of panel sound insulation performed using the empirical method).



Porta scorrevole automatica a tenuta semplice - 1 anta
Automatic simple sealing sliding door - 1 leaf

AUTOMAZIONE ETH/S <i>ETH/S AUTOMATION</i>	HB-SAITS1	HB-SALTS1	HB-SAVTS1
	PANNELLO INOX <i>STAINLESS STEEL PANEL</i>	PANNELLO LAMINATO <i>HPL PANEL</i>	PANNELLO VETRO <i>GLASS PANEL</i>
LARGHEZZA VANO FINO A (LV) <i>OPENING WIDTH UP TO (LV)</i>			
800 mm (31½")	HB-SAITS1-800	HB-SALTS1-800	HB-SAVTS1-800
900 mm (35¼")	HB-SAITS1-900	HB-SALTS1-900	HB-SAVTS1-900
1000 mm (39¾")	HB-SAITS1-1000	HB-SALTS1-1000	HB-SAVTS1-1000
1100 mm (43⅝")	HB-SAITS1-1100	HB-SALTS1-1100	HB-SAVTS1-1100
1200 mm (47¼")	HB-SAITS1-1200	HB-SALTS1-1200	HB-SAVTS1-1200
1300 mm (51¼")	HB-SAITS1-1300	HB-SALTS1-1300	HB-SAVTS1-1300
1400 mm (55⅝")	HB-SAITS1-1400	HB-SALTS1-1400	HB-SAVTS1-1400
1500 mm (59¼")	HB-SAITS1-1500	HB-SALTS1-1500	HB-SAVTS1-1500
1600 mm (63")	HB-SAITS1-1600	HB-SALTS1-1600	HB-SAVTS1-1600
1700 mm (66⅝")	HB-SAITS1-1700	HB-SALTS1-1700	HB-SAVTS1-1700
1800 mm (70¾")	HB-SAITS1-1800	HB-SALTS1-1800	HB-SAVTS1-1800
1900 mm (74⅜")	HB-SAITS1-1900*	HB-SALTS1-1900	HB-SAVTS1-1900
2000 mm (78¾")	HB-SAITS1-2000*	HB-SALTS1-2000	HB-SAVTS1-2000

* Rivestimento in lamiera INOX con giunzione verticale | *Stainless steel cladding with vertical junction*

Elementi Opzionali da ordinare separatamente al momento dell'ordine
Optional items to be ordered separately at time of order

Colorazioni e finiture speciali <i>Special colours and finishes</i>	Fasce / Bands	Rivestimenti gruppo copertura <i>Covering unit cladding</i>	Visiva / Vision panel	Tendine elettriche e manuali <i>Manual and electric blinds</i>	Piombature <i>Lead foils</i>
pag./page 120	pag./page 103	pag./page 102	pag./page 96	pag./page 96	pag./page 104
Maniglie e maniglioni per porte scorrevoli <i>Handle for Sliding Door</i>	Maniglie per porte manuali a battente <i>Level handle for manual swing door</i>	Serrature <i>Mechanical Lock</i>	Dispositivi di impulso (se diversi da quelli standard) <i>Pulse devices (if other than the standard ones)</i>	Batterie di apertura in emergenza <i>Emergency opening batteries</i>	Imbotti e semi-imbotti <i>Wall frame and semi-wall frame</i>
pag./page 108	pag./page 109	pag./page 110	pag./page 117	pag./page 118	pag./page 100

■ Acciaio / ST. Steel ■ Laminato / HPL ■ Vetro / Glass

■ HB-SAITS1 ■ HB-SALTS1

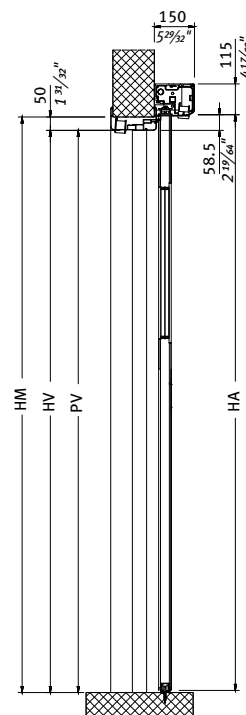
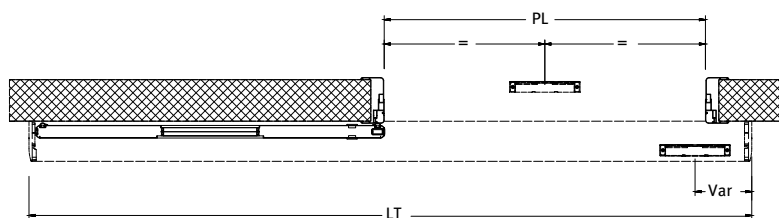
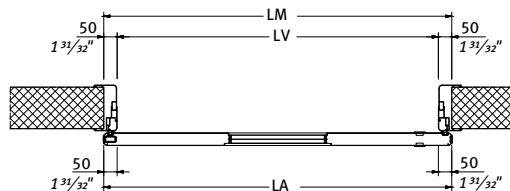
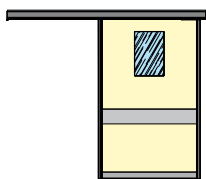
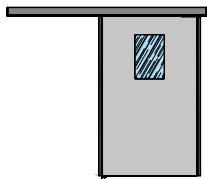

■ HB-SAVTS1

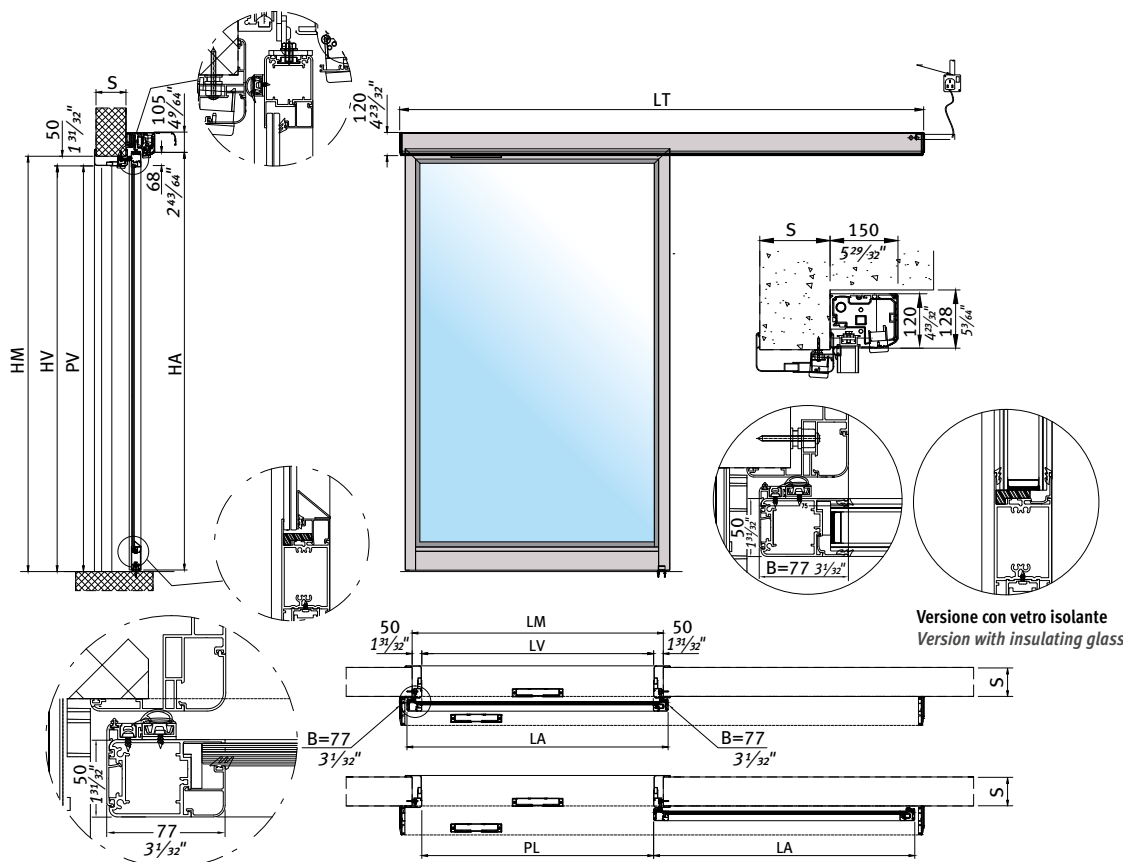

■ ■ ■ **Legenda / Key**

PL	Passaggio netto orizzontale <i>Horizontal net passage</i>	S	Spessore muro <i>Wall thickness</i>	LA	Larghezza anta <i>Leaf width</i>	HV	Altezza vano finito <i>Finished opening height</i>
PV	Passaggio netto verticale <i>Vertical net passage</i>	LM	Larghezza vano grezzo <i>Unfinished opening width</i>	B	Sormonto anta oltre LV <i>Door leaf overlap on the LV</i>	HA	Altezza anta <i>Leaf height</i>
LT	Lunghezza automazione <i>Automation length</i>	LV	Larghezza vano finito <i>Finished opening width</i>	HM	Altezza vano grezzo <i>Unfinished opening height</i>		



Porta scorrevole automatica a tenuta semplice - 2 ante
Automatic simple sealing sliding door - 2 leaves

Tenuta semplice / Simple seal

2 ANTE / 2 LEAVES

AUTOMAZIONE ETH/D ETH/D AUTOMATION	HB-SAITS2	HB-SALTS2	HB-SAVTS2
	PANNELLO INOX STAINLESS STEEL PANEL	PANNELLO LAMINATO HPL PANEL	PANNELLO VETRO GLASS PANEL
LARGHEZZA VANO FINO A (LV) OPENING WIDTH UP TO (LV)			
1000 mm (39 ³ / ₈ "	HB-SAITS2-1000	HB-SALTS2-1000	HB-SAVTS2-1000
1100 mm (43 ⁵ / ₁₆ "	HB-SAITS2-1100	HB-SALTS2-1100	HB-SAVTS2-1100
1200 mm (47 ¹ / ₄ "	HB-SAITS2-1200	HB-SALTS2-1200	HB-SAVTS2-1200
1300 mm (51 ³ / ₈ "	HB-SAITS2-1300	HB-SALTS2-1300	HB-SAVTS2-1300
1400 mm (55 ¹ / ₈ "	HB-SAITS2-1400	HB-SALTS2-1400	HB-SAVTS2-1400
1500 mm (59 ¹ / ₁₆ "	HB-SAITS2-1500	HB-SALTS2-1500	HB-SAVTS2-1500
1600 mm (63"	HB-SAITS2-1600	HB-SALTS2-1600	HB-SAVTS2-1600
1700 mm (66 ¹⁵ / ₁₆ "	HB-SAITS2-1700	HB-SALTS2-1700	HB-SAVTS2-1700
1800 mm (70 ⁷ / ₈ "	HB-SAITS2-1800	HB-SALTS2-1800	HB-SAVTS2-1800
1900 mm (74 ¹³ / ₁₆ "	HB-SAITS2-1900	HB-SALTS2-1900	HB-SAVTS2-1900
2000 mm (78 ³ / ₄ "	HB-SAITS2-2000	HB-SALTS2-2000	HB-SAVTS2-2000
2100 mm (82 ¹ / ₁₆ "	HB-SAITS2-2100	HB-SALTS2-2100	HB-SAVTS2-2100
2200 mm (86 ⁵ / ₈ "	HB-SAITS2-2200	HB-SALTS2-2200	HB-SAVTS2-2200
2300 mm (90 ⁹ / ₁₆ "	HB-SAITS2-2300	HB-SALTS2-2300	HB-SAVTS2-2300
2400 mm (94 ¹ / ₂ "	HB-SAITS2-2400	HB-SALTS2-2400	HB-SAVTS2-2400
2500 mm (98 ⁷ / ₁₆ "	HB-SAITS2-2500	HB-SALTS2-2500	HB-SAVTS2-2500

Elementi Opzionali da ordinare separatamente al momento dell'ordine
Optional items to be ordered separately at time of order

Colorazioni e finiture speciali Special colours and finishes	Fasce / Bands	Rivestimenti gruppo copertura Covering unit cladding	Visiva / Vision panel	Tendine elettriche e manuali Manual and electric blinds	Piombature Lead foils
pag./page 120	pag./page 103	pag./page 102	pag./page 96	pag./page 96	pag./page 104
Maniglie e maniglioni per porte scorrevoli Handle for Sliding Door	Maniglie per porte manuali a battente Level handle for manual swing door	Serrature Mechanical Lock	Dispositivi di impulso (se diversi da quelli standard) Pulse devices (if other than the standard ones)	Batterie di apertura in emergenza Emergency opening batteries	Imbotti e semi-imbotti Wall frame and semi-wall frame
pag./page 108	pag./page 109	pag./page 110	pag./page 117	pag./page 118	pag./page 100

■ Acciaio / ST. Steel ■ Laminato / HPL ■ Vetro / Glass

■ HB-SAITS12

■ HB-SALTS12

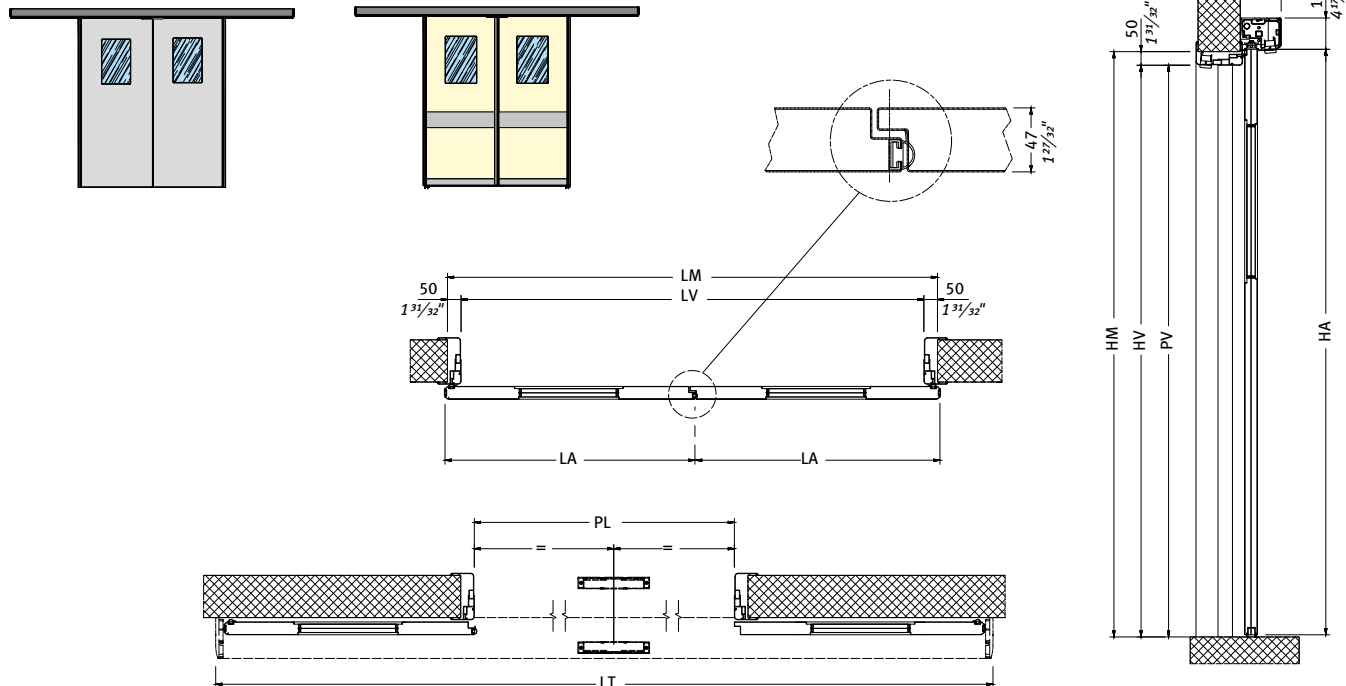

■ HB-SAVTS2

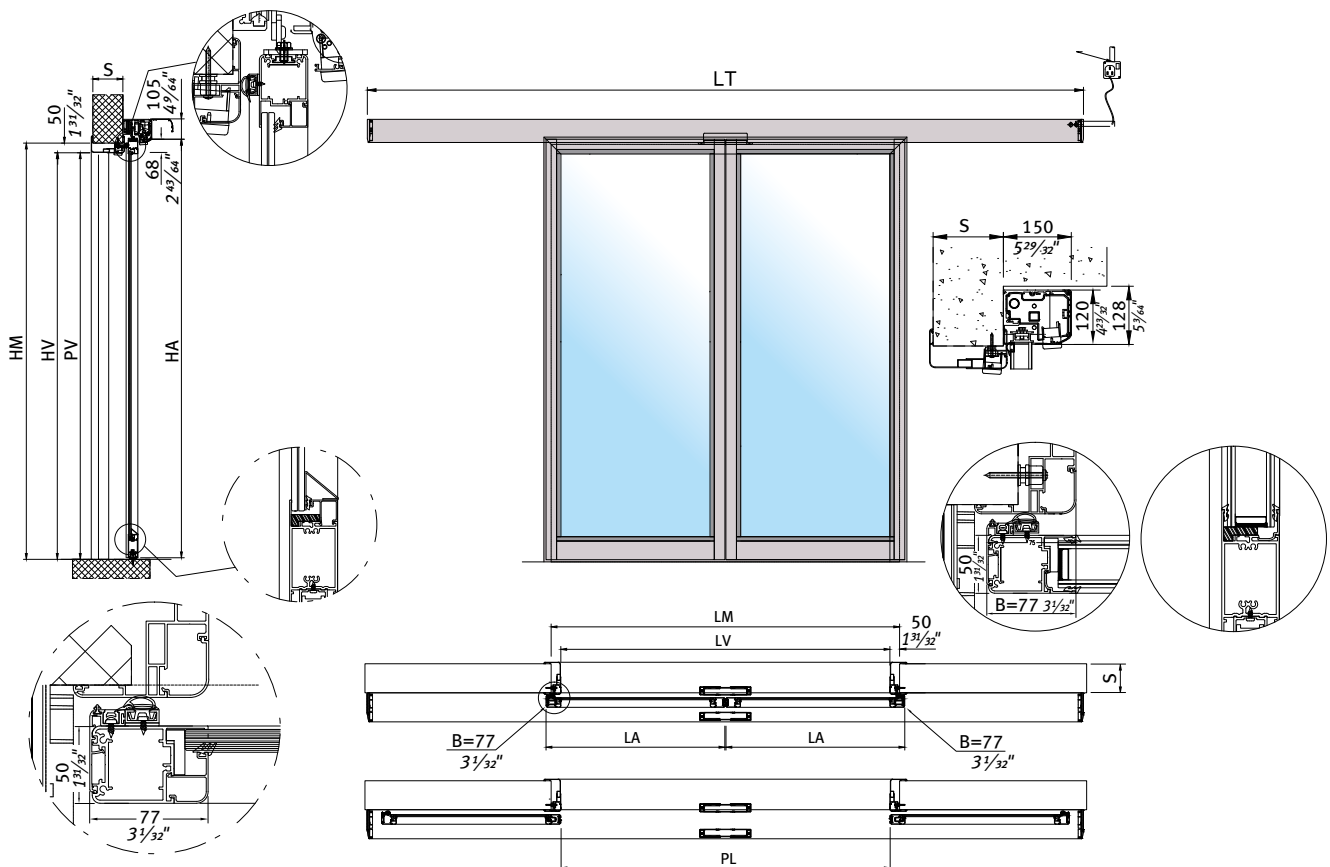

■ ■ ■ **Legenda / Key**





PL	Passaggio netto orizzontale <i>Horizontal net passage</i>	S	Spessore muro <i>Wall thickness</i>	LA	Larghezza anta <i>Leaf width</i>	HV	Altezza vano finito <i>Finished opening height</i>
PV	Passaggio netto verticale <i>Vertical net passage</i>	LM	Larghezza vano grezzo <i>Unfinished opening width</i>	B	Sormonto anta oltre LV <i>Door leaf overlap on the LV</i>	HA	Altezza anta <i>Leaf height</i>
LT	Lunghezza automazione <i>Automation length</i>	LV	Larghezza vano finito <i>Finished opening width</i>	HM	Altezza vano grezzo <i>Unfinished opening height</i>		

PORTE SCORREVOLI MANUALI A TENUTA ERMETICA

La porta in versione manuale e può essere completata con accessori quale visiva, maniglia, fascia paracolpi.

La porta si muove orizzontalmente e, in prossimità della chiusura, la speciale guida superiore consente il movimento di abbassamento e traslazione della porta affinché questa si avvicini sia al muro che al pavimento, garantendo così la tenuta ermetica, mediante la compressione di speciali guarnizioni in gomma presenti sui quattro lati della porta.

I carrelli di sostegno possono supportare e spostare un carico massimo di 150 kg.





Pannelli	Inclusi
	Trave di scorrimento: <ul style="list-style-type: none"> • Trave da 125 mm, copertura ispezionabile in alluminio e fianchetti laterali in ABS • Gruppo copertura da mm 135x180H in lega di alluminio senza viti sulla vista frontale • Portata massima di 150 kg • Rotaia di scorrimento in lega di alluminio sospesa su guida anti-rumore in polizene • Trasmissione del movimento mediante cinghia dentata in gomma con cordoli in kevlar, antistatica • Carrelli con dispositivo anti-deragliamento
	Pannello anta completo di cornici e guarnizioni dedicate
	Anta completa di profili, vetro 44.2 e guarnizioni dedicate
	Gruppo copertura in alluminio nella versione con finitura grezza

MANUAL HERMETICALLY SEALING SLIDING DOORS

The manual version of the door can be supplemented with the following accessories: vision panel, handle, bump band.

The door moves horizontally and, when it is nearly closed, the special upper guide enables the lowering and translation of the door towards the wall and the floor, thereby ensuring the hermetic seal by means of the compression of special rubber gaskets on all four sides of the door.

The support trolleys can bear and convey a maximum load of 150 kg (330lb).

Panels	Includes
	Slideway transom: <ul style="list-style-type: none"> • 125 mm (4¹⁵/₁₆") transom aluminium cover accessible for inspection and ABS side caps • Aluminium alloy covering unit, 135x180H mm (5¹/₁₆" x 7¹/₁₆"H), with no screws visible on the front view • Maximum load capacity of 150 kg (330lb) • Aluminium alloy slideway rail mounted on a sound-dampening polyzene guide • The movement is driven by a rubber antistatic timing belt with Kevlar sides • Trolleys with anti-derailment device
	Leaf panel complete with dedicated frames and gaskets
	Leaf complete with profiles, 44.2 or 8 mm (5/16") glazing, and dedicated gaskets
	Raw aluminium covering unit



 Acciaio / ST.Steel  Laminato / HPL  Vetro / Glass

PORTE SCORREVOLI MANUALI A TENUTA ERMETICA MANUAL HERMETICALLY SEALING SLIDING DOORS

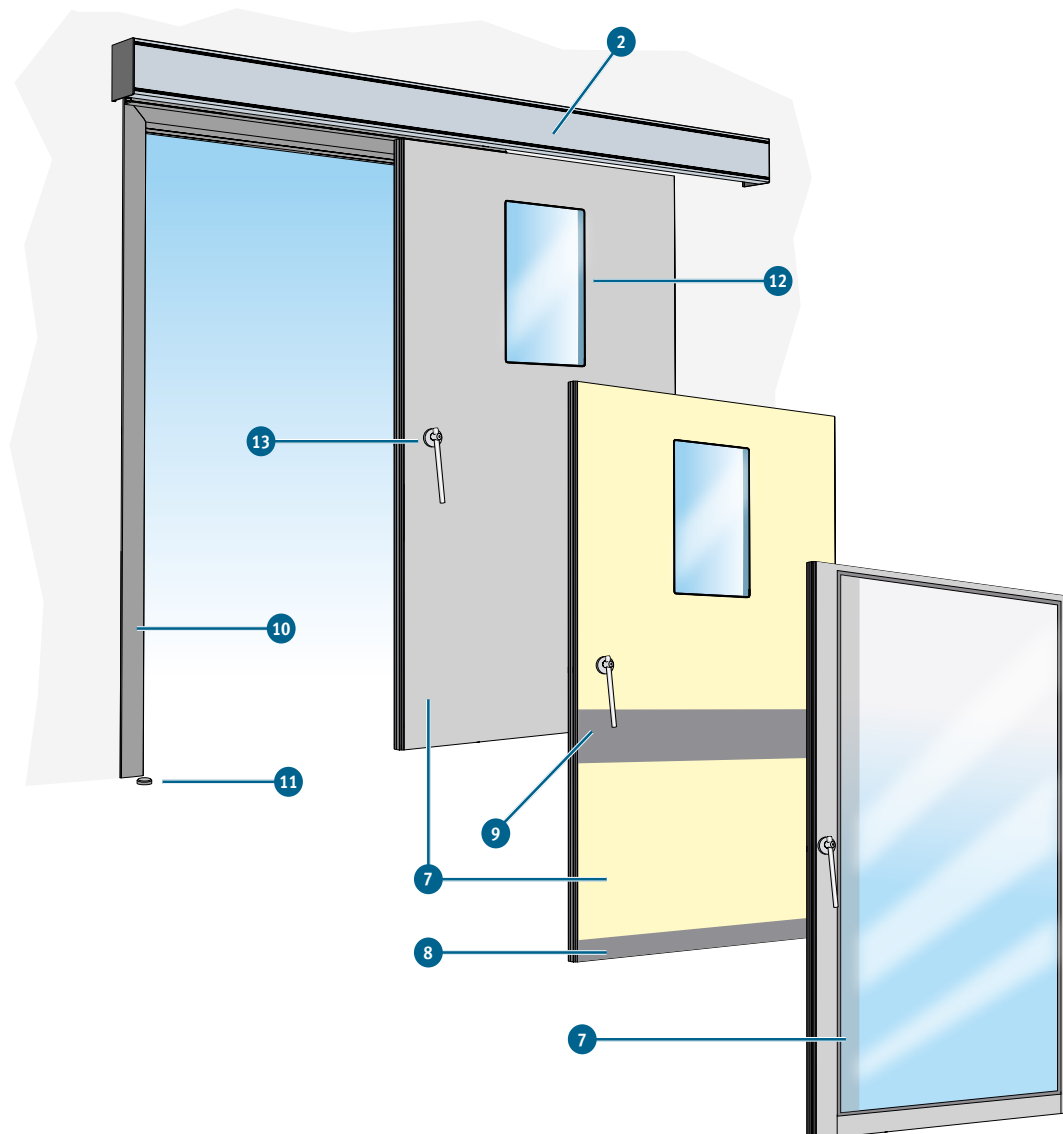

Legenda / Key

2 Gruppo copertura / Cladding unit

7 Pannello / Panel

8 Zoccolo / Base

9 Fascia orizzontale / Horizontal band

10 Imbotte (o semi-imbotte) opzionale / Optional wall frame (or semi-wall frame)

11 Riscontro in chiusura / Closing striker

12 Visiva (opzionale) / Vision panel (optional)

13 Maniglia (opzionale) / Handle (optional)



- Prova di permeabilità all'aria n° 278814
- Misurazione isolamento acustico in laboratorio n° 315233

- ETH-E Air permeability test no. 278814
- Laboratory measurement of sound insulation no. 315233



Porta scorrevole manuale a tenuta ermetica - 1 anta
Manual hermetically sealing sliding door - 1 leaf

	H-SMITE1	H-SMLTE1	H-SMVTE1
	PANNELLO INOX STAINLESS STEEL PANEL	PANNELLO LAMINATO HPL PANEL	PANNELLO VETRO GLASS PANEL
LARGHEZZA VANO FINO A (LV) OPENING WIDTH UP TO (LV)			
800 mm (31½")	H-SMITE1-800	H-SMLTE1-800	H-SMVTE1-800
900 mm (35¼")	H-SMITE1-900	H-SMLTE1-900	H-SMVTE1-900
1000 mm (39¾")	H-SMITE1-1000	H-SMLTE1-1000	H-SMVTE1-1000
1100 mm (43⅝")	H-SMITE1-1100	H-SMLTE1-1100	H-SMVTE1-1100
1200 mm (47¼")	H-SMITE1-1200	H-SMLTE1-1200	H-SMVTE1-1200
1300 mm (51⅜")	H-SMITE1-1300	H-SMLTE1-1300	H-SMVTE1-1300
1400 mm (55½")	H-SMITE1-1400	H-SMLTE1-1400	H-SMVTE1-1400
1500 mm (59⅙")	H-SMITE1-1500	H-SMLTE1-1500	H-SMVTE1-1500
1600 mm (63")	H-SMITE1-1600	H-SMLTE1-1600	H-SMVTE1-1600
1700 mm (66⅜")	H-SMITE1-1700	H-SMLTE1-1700	H-SMVTE1-1700
1800 mm (70¾")	H-SMITE1-1800	H-SMLTE1-1800	H-SMVTE1-1800
1900 mm (74⅜")	H-SMITE1-1900*	H-SMLTE1-1900	H-SMVTE1-1900
2000 mm (78¾")	H-SMITE1-2000*	H-SMLTE1-2000	H-SMVTE1-2000

* Rivestimento in lamiera INOX con giunzione verticale | *Stainless steel cladding with vertical junction*

Elementi Opzionali da ordinare separatamente al momento dell'ordine
Optional items to be ordered separately at time of order

Colorazioni e finiture speciali <i>Special colours and finishes</i> pag./page 120	Fasce / Bands pag./page 103	Rivestimenti gruppo copertura <i>Covering unit cladding</i> pag./page 102	Visiva / Vision panel pag./page 96	Tendine elettriche e manuali <i>Manual and electric blinds</i> pag./page 96	Piombature <i>Lead foils</i> pag./page 104
Maniglie e maniglioni per porte scorrevoli <i>Handle for Sliding Door</i> pag./page 108	Maniglie per porte manuali a battente <i>Level handle for manual swing door</i> pag./page 109	Serrature <i>Mechanical Lock</i> pag./page 110	Dispositivi di impulso (se diversi da quelli standard) <i>Pulse devices (if other than the standard ones)</i> pag./page 117	Batterie di apertura in emergenza <i>Emergency opening batteries</i> pag./page 118	Imbotti e semi-imbotti <i>Wall frame and semi-wall frame</i> pag./page 100

■ Acciaio / ST.Steel ■ Laminato / HPL ■ Vetro / Glass

■ H-SMITE1

■ H-SMLTE1

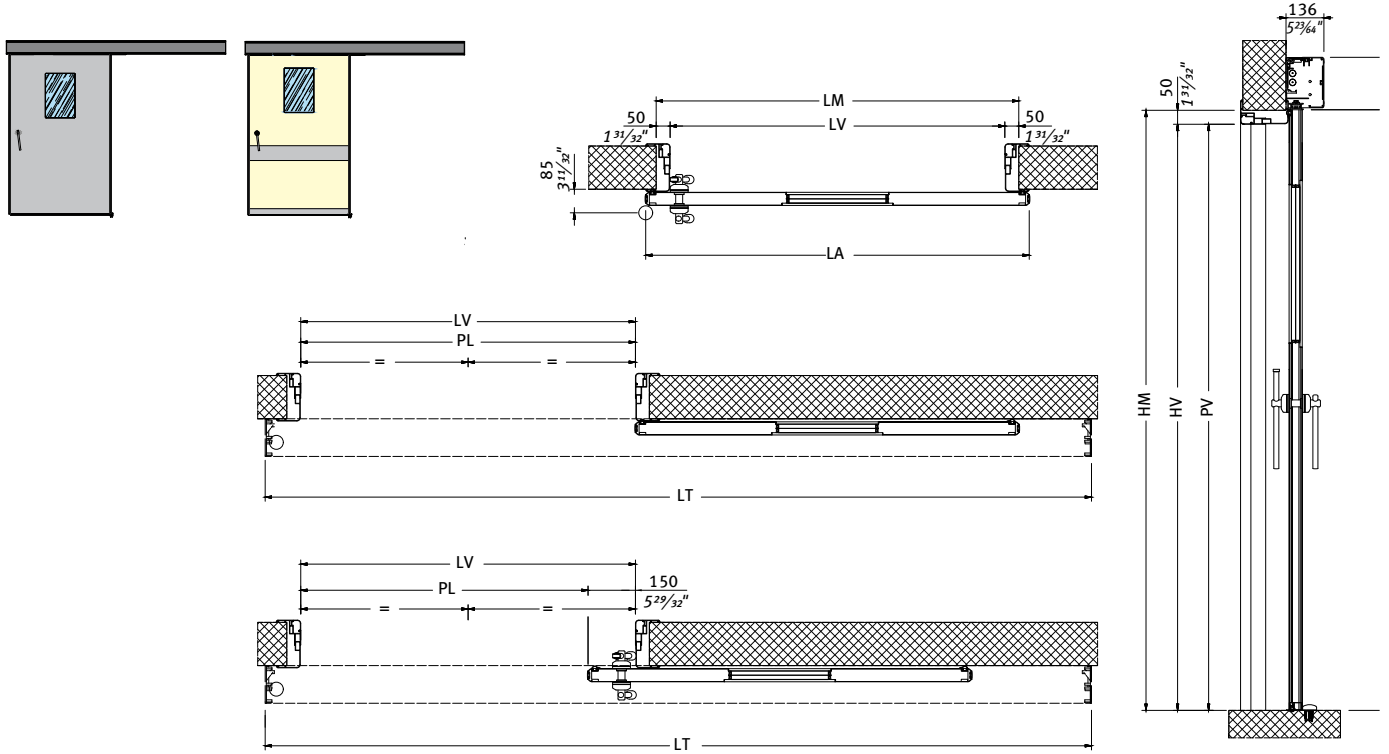

■ H-SMVTE1

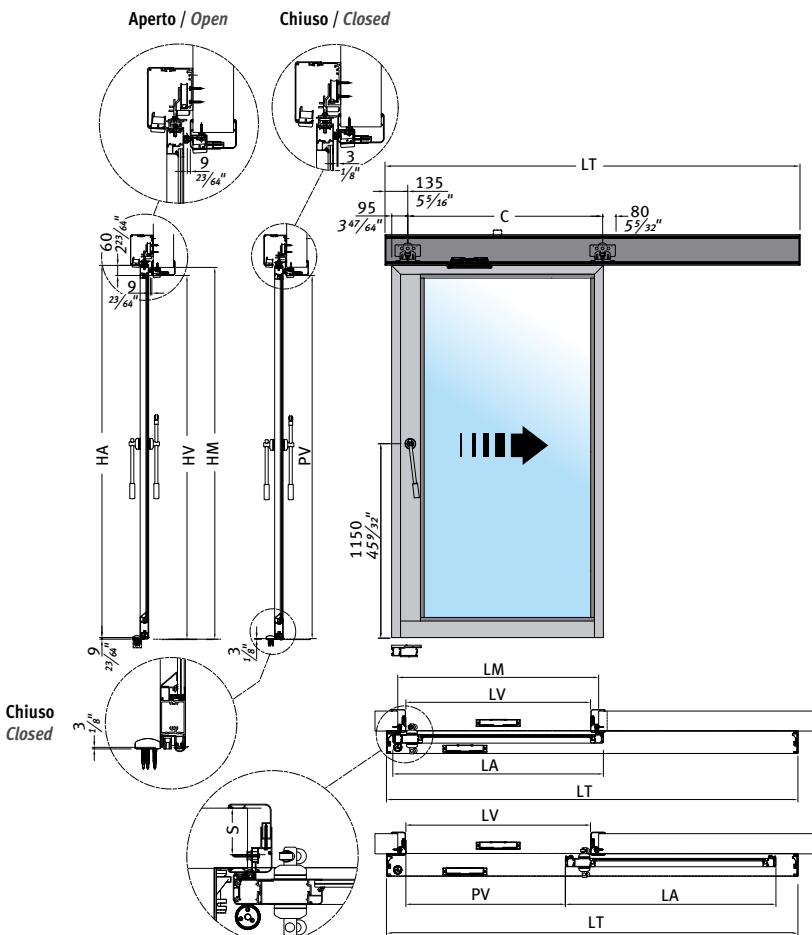

■ ■ ■ **Legenda / Key**

PL	Passaggio netto orizzontale <i>Horizontal net passage</i>
PV	Passaggio netto verticale <i>Vertical net passage</i>
LT	Lunghezza automazione <i>Automation length</i>
S	Spessore muro <i>Wall thickness</i>
LM	Larghezza vano grezzo <i>Unfinished opening width</i>
LV	Larghezza vano finito <i>Finished opening width</i>
LA	Larghezza anta <i>Leaf width</i>
HM	Altezza vano grezzo <i>Unfinished opening height</i>
HV	Altezza vano finito <i>Finished opening height</i>
HA	Altezza anta <i>Leaf height</i>

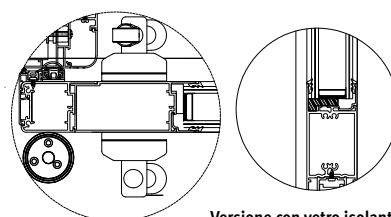





Versione con vetro isolante
Version with insulating glass

PORTE SCORREVOLI MANUALI A TENUTA SEMPLICE

La porta in versione manuale può essere completata con accessori quale visiva, maniglia, fascia paracolpi, e serratura manuale.

La porta si muove orizzontalmente e, in prossimità della chiusura, va in appoggio sui montanti ed il traverso del telaio sporgente a muro garantendo, mediante la compressione di speciali guarnizioni in gomma presenti sui due lati verticali e sul lato orizzontale superiore della porta, la tenuta all'aria.

I carrelli di sostegno possono supportare e spostare un carico massimo di 300 kg per porta ad anta singola.





Pannelli	Inclusi
	Trave di scorrimento: <ul style="list-style-type: none"> • TRAVE da 78 mm, copertura ispezionabile in alluminio e fianchetti laterali in ABS • Portata massima di 400 kg per porta a doppia anta o 300 kg per porta ad anta singola • Lunghezza massima trave: 6500 mm • Gruppo copertura da mm 150x120H in lega di alluminio con articolazione per sgancio e supporto • Pista di scorrimento in lega di alluminio sospesa su guida anti-rumore in polizene • Trasmissione del movimento mediante cinghia dentata in gomma con cordoli in kevlar, antistatica • Carrelli a doppia ruota con dispositivo anti-deragliamento
	Pannello anta completo di cornici e guarnizioni dedicate
	Anta completa di profili, vetro 44.2 e guarnizioni dedicate
	Gruppo copertura in alluminio nella versione con finitura grezza
	Binario superiore con finitura grezza

MANUAL SIMPLE SEALING SLIDING DOORS

The manual version of the door can be supplemented with the following accessories: vision panel, handle, bump band, and manual lock.

The door moves horizontally and, when it is nearly closed, it comes to rest against the uprights and the crossbar of the frame, which extends out from the wall, ensuring, through the compression of special rubber gaskets on the two vertical sides and the top horizontal side of the door, an airtight seal.

The support trolleys can bear and convey a maximum load of 300 kg (661lb) per single-leaf door.

Panels	Includes
	Slideway transom: <ul style="list-style-type: none"> • 78-mm (3¹/₁₆") transom, aluminium cover accessible for inspection and ABS side caps • Maximum load capacity of 400 kg (881lb) for a double-leaf door or 300 kg (661lb) for a single-leaf door • Maximum transom length: 6500 mm (255¹⁵/₁₆") • Aluminium alloy covering unit, 150x120H mm (5¹/₁₆" x 4³/₄"H), with release and support articulation • Aluminium alloy slideway rail mounted on a sound-dampening polyzene guide • The movement is driven by a rubber antistatic timing belt with Kevlar sides • Double-wheel trolleys with anti-derailment device
	Leaf panel complete with dedicated frames and gaskets
	Leaf complete with profiles, 44.2 or 8 mm (5/16") glazing, and dedicated gaskets
	Raw aluminium covering unit
	Upper rail in raw aluminium



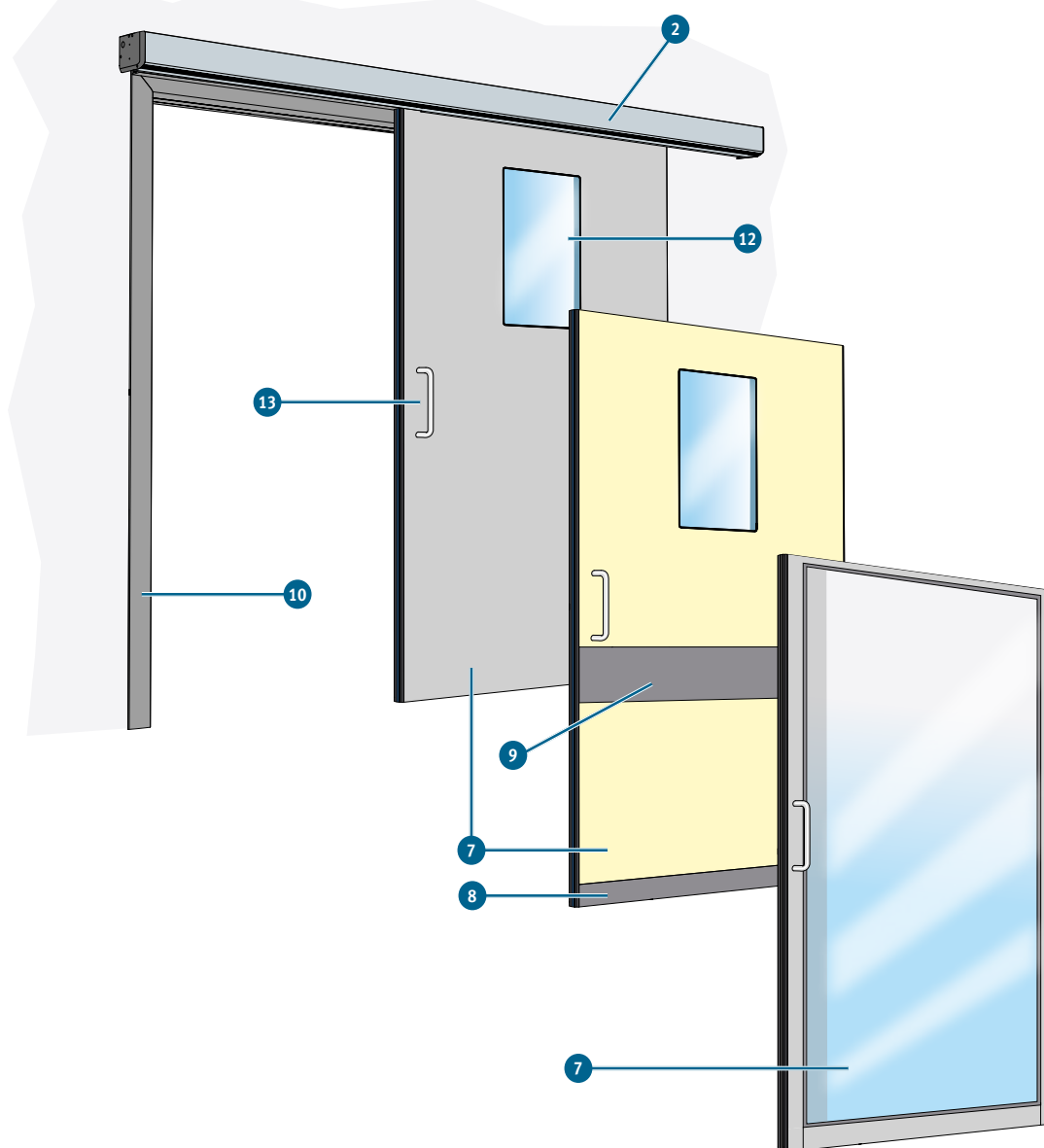

Legenda / Key

2 Gruppo copertura / Cladding unit

7 Pannello / Panel

8 Zoccolo / Base

9 Fascia orizzontale / Horizontal band

10 Imbotte (o semi-imbotte) opzionale
 Optional wall frame (or semi-wall frame)

12 Visiva (opzionale) / Vision panel (optional)

13 Maniglia (opzionale) / Handle (optional)



• Misurazione in laboratorio isolamento acustico n° 315230
 (misurazione isolamento acustico sui pannelli effettuata con metodo empirico).

• Laboratory measurement of sound insulation no. 315230
 (measurement of panel sound insulation performed using the empirical method).



Porta scorrevole manuale a tenuta semplice - 1 anta
Manual single sealing sliding door - 1 leaf

Tenuta semplice / Simple seal

1 ANTA / 1 LEAF

	H-SMITS1	H-SMLTS1	H-SMVTS1
	PANNELLO INOX STAINLESS STEEL PANEL	PANNELLO LAMINATO HPL PANEL	PANNELLO VETRO GLASS PANEL
LARGHEZZA VANO FINO A (LV) OPENING WIDTH UP TO (LV)			
800 mm (31½")	H-SMITS1-800	H-SMLTS1-800	H-SMVTS1-800
900 mm (35¼")	H-SMITS1-900	H-SMLTS1-900	H-SMVTS1-900
1000 mm (39¾")	H-SMITS1-1000	H-SMLTS1-1000	H-SMVTS1-1000
1100 mm (43¾")	H-SMITS1-1100	H-SMLTS1-1100	H-SMVTS1-1100
1200 mm (47¼")	H-SMITS1-1200	H-SMLTS1-1200	H-SMVTS1-1200
1300 mm (51¼")	H-SMITS1-1300	H-SMLTS1-1300	H-SMVTS1-1300
1400 mm (55½")	H-SMITS1-1400	H-SMLTS1-1400	H-SMVTS1-1400
1500 mm (59¼")	H-SMITS1-1500	H-SMLTS1-1500	H-SMVTS1-1500
1600 mm (63")	H-SMITS1-1600	H-SMLTS1-1600	H-SMVTS1-1600
1700 mm (66¾")	H-SMITS1-1700	H-SMLTS1-1700	H-SMVTS1-1700
1800 mm (70¾")	H-SMITS1-1800	H-SMLTS1-1800	H-SMVTS1-1800
1900 mm (74¾")	H-SMITS1-1900*	H-SMLTS1-1900	H-SMVTS1-1900
2000 mm (78¾")	H-SMITS1-2000*	H-SMLTS1-2000	H-SMVTS1-2000

* Rivestimento in lamiera INOX con giunzione verticale | *Stainless steel cladding with vertical junction*

Elementi Opzionali da ordinare separatamente al momento dell'ordine
Optional items to be ordered separately at time of order

Colorazioni e finiture speciali <i>Special colours and finishes</i>	Fasce / Bands	Rivestimenti gruppo copertura <i>Covering unit cladding</i>	Visiva / Vision panel	Tendine elettriche e manuali <i>Manual and electric blinds</i>	Piombature <i>Lead foils</i>
pag./page 120	pag./page 103	pag./page 102	pag./page 96	pag./page 96	pag./page 104
Maniglie e maniglioni per porte scorrevoli <i>Handle for Sliding Door</i>	Maniglie per porte manuali a battente <i>Level handle for manual swing door</i>	Serrature <i>Mechanical Lock</i>	Dispositivi di impulso (se diversi da quelli standard) <i>Pulse devices (if other than the standard ones)</i>	Batterie di apertura in emergenza <i>Emergency opening batteries</i>	Imbotti e semi-imbotti <i>Wall frame and semi-wall frame</i>
pag./page 108	pag./page 109	pag./page 110	pag./page 117	pag./page 118	pag./page 100

■ Acciaio / ST. Steel ■ Laminato / HPL ■ Vetro / Glass

■ H-SMITS1

■ H-SMLTS1

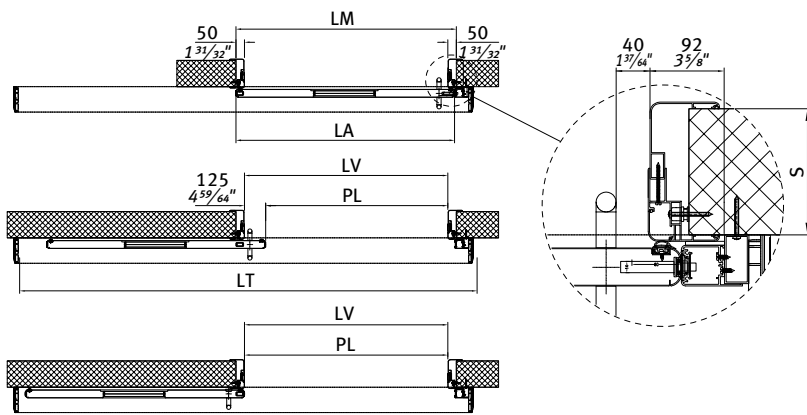
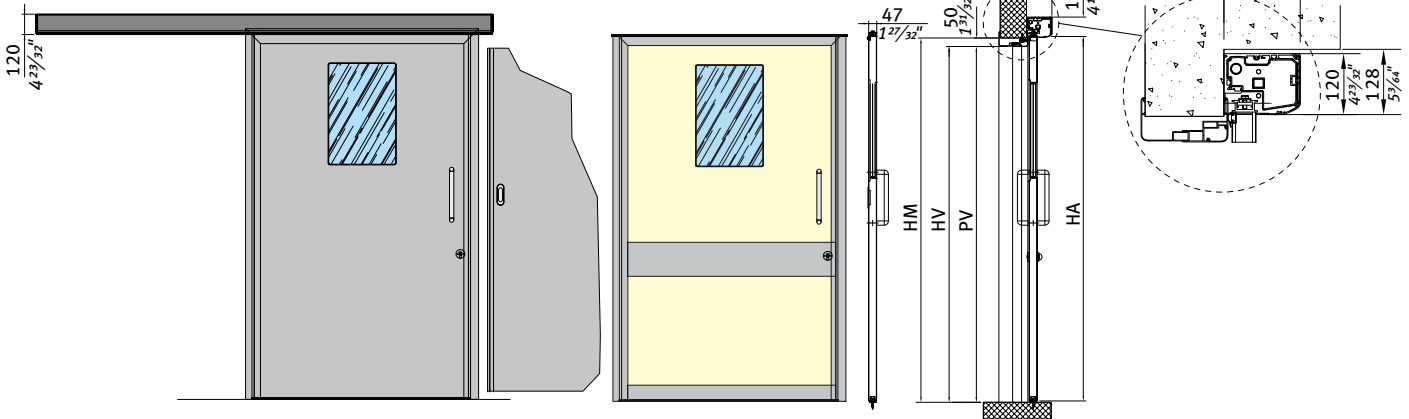

■ H-SMVTs1

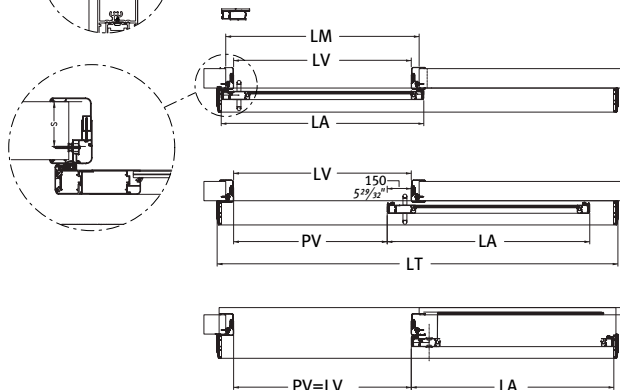
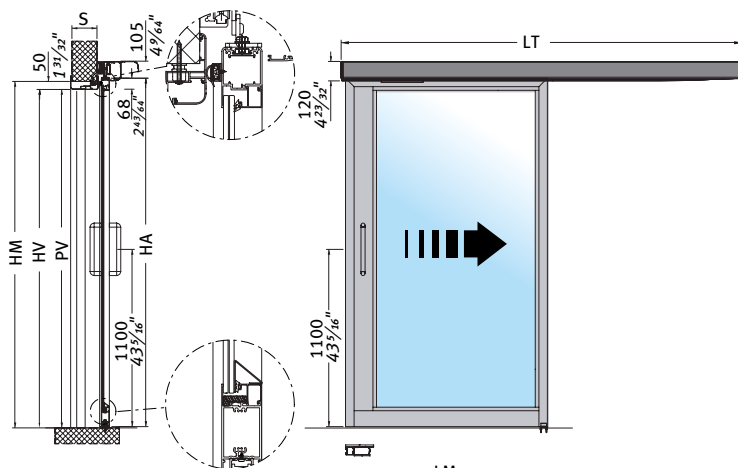

■ ■ ■ **Legenda / Key**

PL	Passaggio netto orizzontale <i>Horizontal net passage</i>
PV	Passaggio netto verticale <i>Vertical net passage</i>
LT	Lunghezza automazione <i>Automation length</i>
S	Spessore muro <i>Wall thickness</i>
LM	Larghezza vano grezzo <i>Unfinished opening width</i>
LV	Larghezza vano finito <i>Finished opening width</i>
LA	Larghezza anta <i>Leaf width</i>
HM	Altezza vano grezzo <i>Unfinished opening height</i>
HV	Altezza vano finito <i>Finished opening height</i>
HA	Altezza anta <i>Leaf height</i>

Versione con vetro isolante
Version with insulating glass

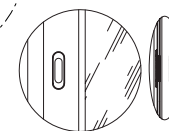
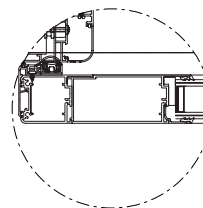

Maniglia ad
incasso ovale
*Recessed oval
handle*



Porta scorrevole manuale a tenuta semplice - 2 ante
Manual single sealing sliding door - 2 leaves

Tenuta semplice / Simple seal

2 ANTE / 2 LEAVES

	H-SMITS2	H-SMLTS2	H-SMVTS2
	PANNELLO INOX STAINLESS STEEL PANEL	PANNELLO LAMINATO HPL PANEL	PANNELLO VETRO GLASS PANEL
LARGHEZZA VANO FINO A (LV) OPENING WIDTH UP TO (LV)			
1000 mm (39 ³ / ₁₆ "	H-SMITS2-1000	H-SMLTS2-1000	H-SMVTS2-1000
1100 mm (43 ⁵ / ₁₆ "	H-SMITS2-1100	H-SMLTS2-1100	H-SMVTS2-1100
1200 mm (47 ¹ / ₄ "	H-SMITS2-1200	H-SMLTS2-1200	H-SMVTS2-1200
1300 mm (51 ³ / ₁₆ "	H-SMITS2-1300	H-SMLTS2-1300	H-SMVTS2-1300
1400 mm (55 ¹ / ₈ "	H-SMITS2-1400	H-SMLTS2-1400	H-SMVTS2-1400
1500 mm (59 ¹ / ₁₆ "	H-SMITS2-1500	H-SMLTS2-1500	H-SMVTS2-1500
1600 mm (63")	H-SMITS2-1600	H-SMLTS2-1600	H-SMVTS2-1600
1700 mm (66 ¹ / ₁₆ "	H-SMITS2-1700	H-SMLTS2-1700	H-SMVTS2-1700
1800 mm (70 ⁷ / ₈ "	H-SMITS2-1800	H-SMLTS2-1800	H-SMVTS2-1800
1900 mm (74 ¹³ / ₁₆ "	H-SMITS2-1900	H-SMLTS2-1900	H-SMVTS2-1900
2000 mm (78 ³ / ₄ "	H-SMITS2-2000	H-SMLTS2-2000	H-SMVTS2-2000
2100 mm (82 ¹¹ / ₁₆ "	H-SMITS2-2100	H-SMLTS2-2100	H-SMVTS2-2100
2200 mm (86 ⁵ / ₈ "	H-SMITS2-2200	H-SMLTS2-2200	H-SMVTS2-2200
2300 mm (90 ⁹ / ₁₆ "	H-SMITS2-2300	H-SMLTS2-2300	H-SMVTS2-2300
2400 mm (94 ¹ / ₂ "	H-SMITS2-2400	H-SMLTS2-2400	H-SMVTS2-2400
2500 mm (98 ⁷ / ₁₆ "	H-SMITS2-2500	H-SMLTS2-2500	H-SMVTS2-2500

Elementi Opzionali da ordinare separatamente al momento dell'ordine
Optional items to be ordered separately at time of order

Colorazioni e finiture speciali Special colours and finishes	Fasce / Bands	Rivestimenti gruppo copertura Covering unit cladding	Visiva / Vision panel	Tendine elettriche e manuali Manual and electric blinds	Piombature Lead foils
pag./page 120	pag./page 103	pag./page 102	pag./page 96	pag./page 96	pag./page 104
Maniglie e maniglioni per porte scorrevoli Handle for Sliding Door	Maniglie per porte manuali a battente Level handle for manual swing door	Serrature Mechanical Lock	Dispositivi di impulso (se diversi da quelli standard) Pulse devices (if other than the standard ones)	Batterie di apertura in emergenza Emergency opening batteries	Imbotti e semi-imbotti Wall frame and semi-wall frame
pag./page 108	pag./page 109	pag./page 110	pag./page 117	pag./page 118	pag./page 100

■ Acciaio / ST.Steel ■ Laminato / HPL ■ Vetro / Glass

■ H-SMITS2

■ H-SMLTS2

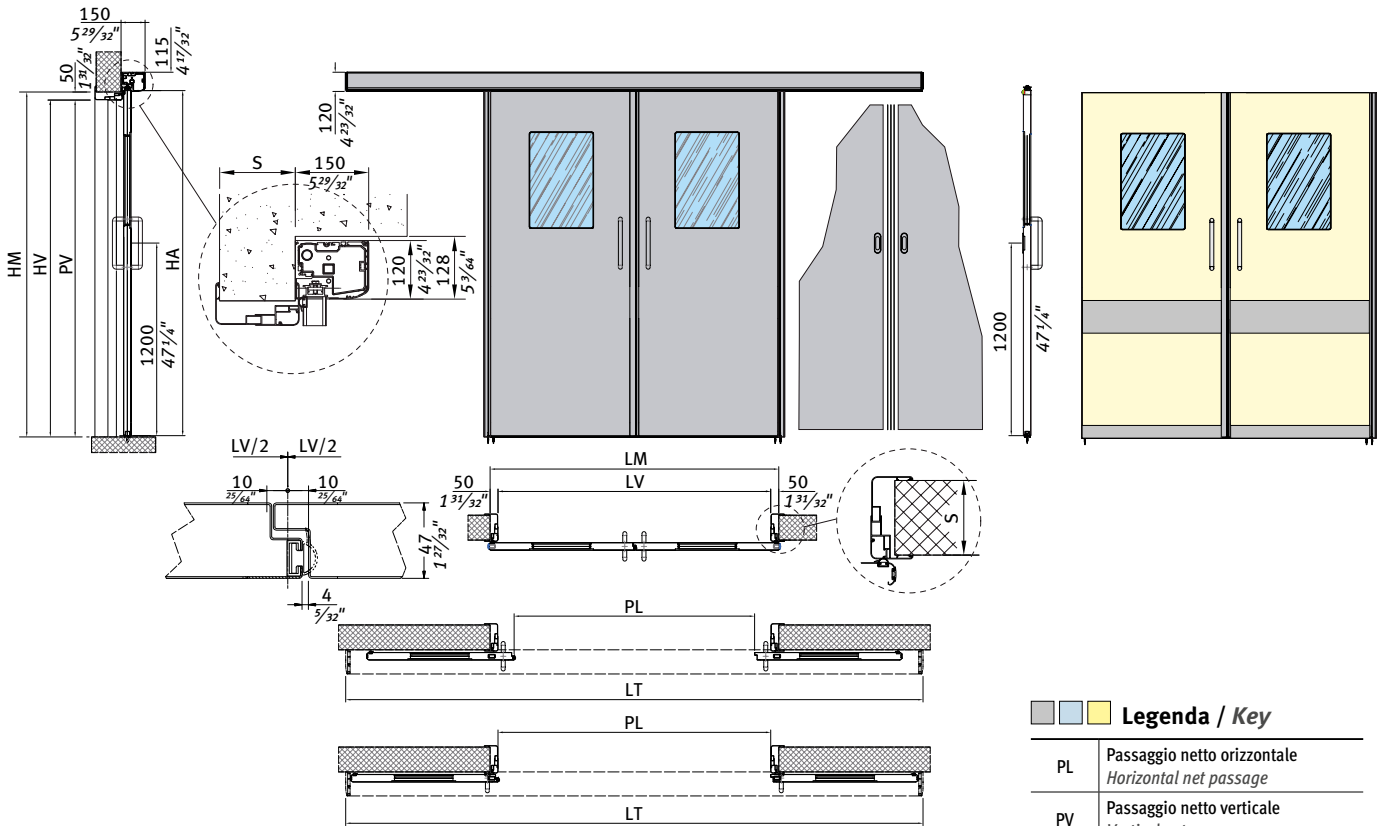

■ H-SMVT2

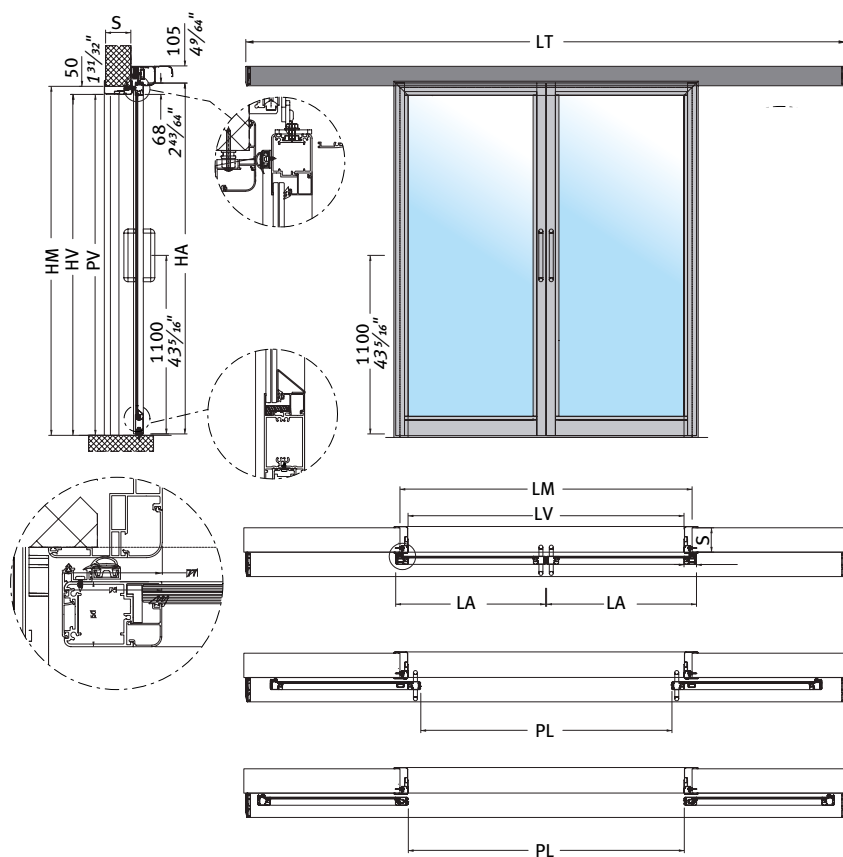

■ ■ ■ **Legenda / Key**

PL	Passaggio netto orizzontale <i>Horizontal net passage</i>
PV	Passaggio netto verticale <i>Vertical net passage</i>
LT	Lunghezza automazione <i>Automation length</i>
S	Spessore muro <i>Wall thickness</i>
LM	Larghezza vano grezzo <i>Unfinished opening width</i>
LV	Larghezza vano finito <i>Finished opening width</i>
LA	Larghezza anta <i>Leaf width</i>
HM	Altezza vano grezzo <i>Unfinished opening height</i>
HV	Altezza vano finito <i>Finished opening height</i>
HA	Altezza anta <i>Leaf height</i>

Versione con vetro isolante
Version with insulating glass

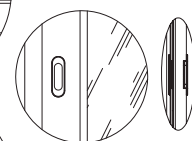

Maniglia ad
incasso ovale
*Recessed oval
handle*



PORTE
A BATTENTE

SWING DOORS

Le porte a battente ospedaliere Label sono disponibili nelle versioni automatiche o ad apertura manuale.

La semplicità del sistema modulare delle porte ospedaliere Label vi permette di “comporre” la vostra porta ideale scegliendo:

- la finitura della pannellatura: che può essere in acciaio inox, laminata o in vetro trasparente o Smart Glass;
- la versione a un’anta, due ante o asimmetrica;
- la tenuta: semplice o ermetica
- il grado di protezione dai raggi X, tramite lastre di piombo da 1 a 4 mm di spessore
- il comando di apertura: è disponibile un’ampia scelta di maniglie e maniglioni, interblocchi, pulsanti e semafori.

Label Hospital swing doors are available in automatic or manual opening versions.

The simplicity of the Label Hospital door modular system allows “composing” your ideal door by choosing:

- *the finish of the panels: in stainless steel, HPL, clear glass, or Smart Glass;*
- *one-leaf, two-leaf, or asymmetrical version;*
- *sealing: simple or hermetic*
- *the protection class against X-rays, by means of 1 (1/16”) to 4 (3/16”) mm thick lead plates*
- *the opening control: a wide choice of handles and pull handles, interlocks, buttons, and signaling lights are available.*

Operatore conforme alle norme europee

Automation in compliance with European standards

EN 16005; EN 13849-1; EN 13849 -2; EN 61000-6-2; EN 61000-6-3;
EN 60335-2-103; DIN 18650-1; DIN 18650-2



LEGENDA PITTOGRAMMI TABELLE - TABLES PICTOGRAMS LEGEND

	Codice Code		Descrizione Description		Spessore muro Wall thickness		Confezione Package
	Funzionamento Automatico Automatic operation		Funzionamento Manuale Manual operation		Tenuta Ermetica Hermetic seal		Tenuta Semplice Simple seal
	Battente Swing		Anta Leaf		Scorrevole Sliding		Finitura Finish

LEGENDA PREZZI

I prezzi sono espressi in € e indicano il prezzo unitario o il prezzo al metro

Esempio: 5,00 = (prezzo unitario)
Esempio: 5,00/m = (prezzo al metro)

PRICES LEGEND

Prices are in € and indicate the unit price or the price per meter







Example: 5,00 = (unit price)
Example: 5,00/m = (price per meter)

PORTE AUTOMATICHE A BATTENTE A TENUTA SEMPLICE

Per uso non intensivo e privo di delta di pressione.
La porta in versione automatica è fornita con telaio a muro porta cerniere, predisposto per il montaggio su mazzetta a muro o controtelaio e può essere completata con accessori quale visiva, maniglia, fascia paracolpi, dispositivi di impulso e sensori di sicurezza (radar, sensori a raggi infrarossi). La tenuta è garantita da guarnizioni in EPDM espanse montate sui profili in alluminio che coprono tre lati del perimetro dell'anta.
Nella parte inferiore è installata, di serie, una spazzola in setole rigide.

Automazione

- Automazione mod. NEXT 75 per porte a battente, apertura e chiusura a motore per anta larghezza massima 1000 mm
- Peso massimo per anta: kg 75
- Dimensioni automazione (HxPxL) 60x75x420 mm







Pannelli	Inclusi
	Automazione NEXT 75: <ul style="list-style-type: none"> • Automazione elettromeccanica per uso intensivo • Copertura in alluminio colore argento anodizzato naturale - H.60 mm • Base supporto in alluminio • Fianchetti in ABS grigi • Alimentazione a 115/230Vac - 50/60Hz • Motore brushless con encoder incorporato ad elevate prestazioni, bassa usura e consumi ridotti • Sistema di trasmissione movimento tramite ingranaggi a ruote dentate estremamente silenzioso
	Pannello anta completo di cornici e guarnizioni dedicate
	Anta completa di profili, vetro 44.2, e guarnizioni dedicate
	Gruppo copertura in alluminio
	Braccio a tirare HB-NEXTBDT o a spingere NEXT-BAS
	Programmatore digitale e sensori di sicurezza

AUTOMATIC SIMPLE SEALING SWING DOORS

For non-intensive use without pressure delta.
The automatic version of the door comes with a wall frame equipped for hinges, ready to be mounted on wall rabbets or on a subframe. It can be supplemented with the following accessories: vision panel, handle, bump band, pulse devices and safety sensors (radar, infrared sensors). Tightness is provided by expanded EPDM gaskets mounted on the aluminium profiles that cover three sides of the leaf perimeter.
A rigid-bristle brush is installed as standard on the bottom edge.

Automation

- NEXT 75 automation model for swing doors, motorized opening and closing, for a leaf maximum width of 1000 mm (39³/₈"
- Maximum weight for each leaf: 75 kg (165lb)
- Automation dimensions (HxDxL) 60x75x420 mm (2³/₈" x 2¹⁵/₁₆" x 16⁹/₁₆"

Panels	Includes
	Automation NEXT 75: <ul style="list-style-type: none"> • Heavy-duty electromechanical automation • Aluminium cover in natural anodized-silver colour - H.60 mm (2³/₈"). • Aluminium support base • Grey ABS side caps • 115/230Vac - 50/60Hz power supply • Brushless motor with built-in encoder, featuring high performance, low wear, low power consumption • Very quiet gear-driven motion transmission system
	Leaf panel complete with dedicated frames and gaskets
	Leaf complete with profiles, 44.2 or 8 mm (5/16") glazing, and dedicated gaskets
	Aluminium covering unit in HPL version
	Pull arm HB-NEXTBDT or push arm NEXT-BAS
	Digital selector and safety sensors



 Acciaio / ST.Steel  Laminato / HPL  Vetro / Glass



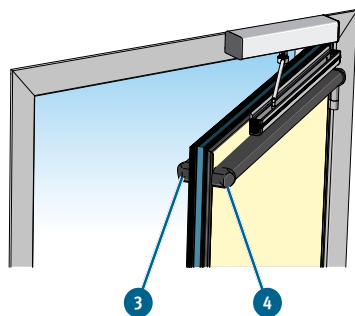

Esempio automazione
 Con braccio "a tirare"
 Example of automation with
 "Pull arm"

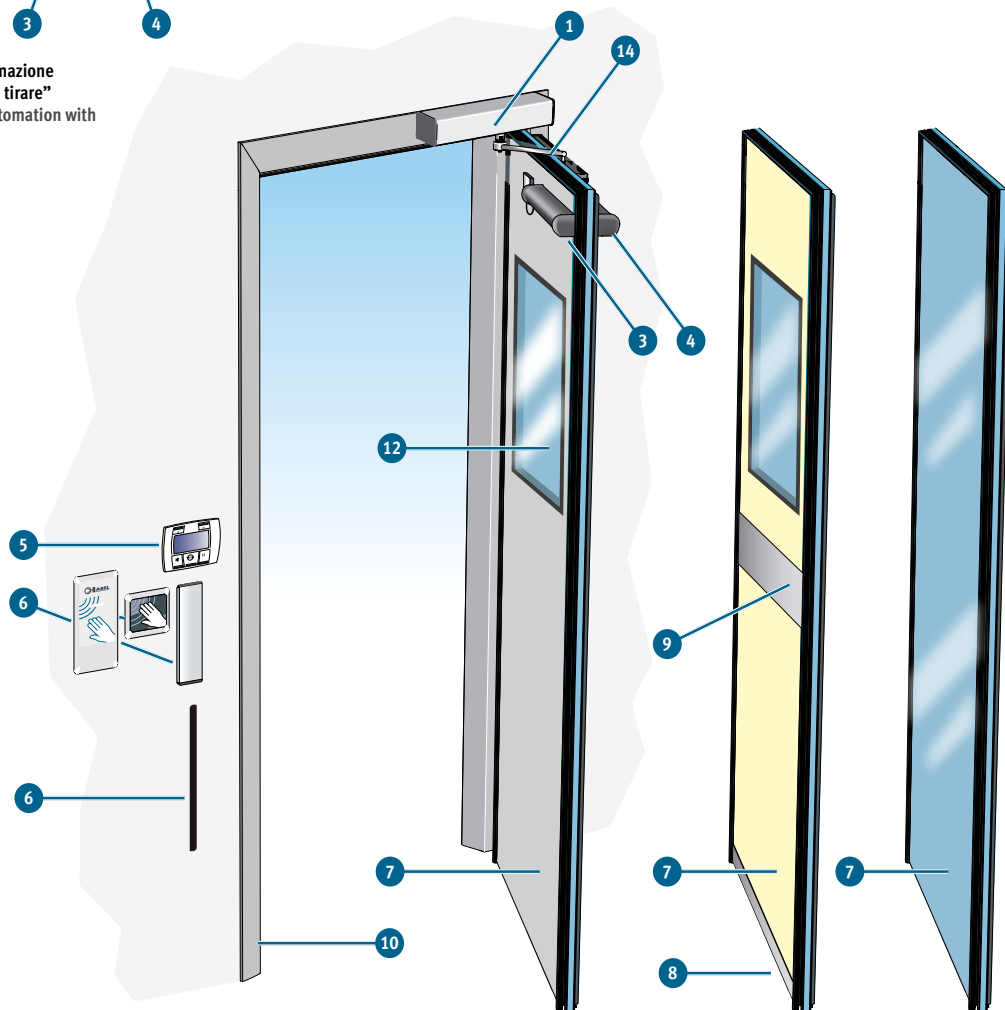

Legenda / Key

1 Gruppo automazione / Automation unit

3 Sensore di sicurezza lato chiusura / Closing-side safety sensor

4 Sensore di sicurezza lato apertura / Opening-side safety sensor

5 Programmatore digitale / Digital programmer

6 Dispositivi di attivazione / Activation devices

7 Pannello / Panel

8 Zoccolo / Base

9 Fascia orizzontale / Horizontal band

10 Telaio / Frame

12 Visiva (opzionale) / Vision panel (optional)

14 Braccio (a tirare o a spingere) / Arm (pull or push)



Porta automatica a battente a tenuta semplice - 1 anta
Automatic simple sealing swing door - 1 leaf

Tenuta semplice / Simple seal

1 ANTA / 1 LEAF

AUTOMAZIONE NEXT 75 NEXT 75 AUTOMATION	HB-B7511	HB-B75L1	HB-B75V1
	PANNELLO INOX STAINLESS STEEL PANEL	PANNELLO LAMINATO HPL PANEL	PANNELLO VETRO GLASS PANEL
LARGHEZZA VANO FINO A (LV) OPENING WIDTH UP TO (LV)			
800 mm (31½")	HB-B7511-800	HB-B75L1-800	HB-B75V1-800
900 mm (35¼")	HB-B7511-900	HB-B75L1-900	HB-B75V1-900
1000 mm (39¾")	HB-B7511-1000	HB-B75L1-1000	HB-B75V1-1000

NOTA:
Per ogni tipologia di porta è necessario specificare l'apertura se "A SPINGERE" o "A TIRARE" con riferimento vista lato automazione.

NOTE:
For every type you must specify the type of opening, whether "PUSH" or "PULL", as seen from the operator side.

Elementi Opzionali da ordinare separatamente al momento dell'ordine
Optional items to be ordered separately at time of order

Colorazioni e finiture speciali Special colours and finishes	Fasce / Bands	Rivestimenti gruppo copertura Covering unit cladding	Visiva / Vision panel	Tendine elettriche e manuali Manual and electric blinds	Piombature Lead foils
pag./page 120	pag./page 103	pag./page 102	pag./page 96	pag./page 96	pag./page 104
Maniglie e maniglioni per porte scorrevoli Handle for Sliding Door	Maniglie per porte manuali a battente Level handle for manual swing door	Serrature Mechanical Lock	Dispositivi di impulso (se diversi da quelli standard) Pulse devices (if other than the standard ones)	Batterie di apertura in emergenza Emergency opening batteries	Imbotti e semi-imbotti Wall frame and semi-wall frame
pag./page 108	pag./page 109	pag./page 110	pag./page 117	pag./page 118	pag./page 100

■ Acciaio / ST. Steel ■ Laminato / HPL ■ Vetro / Glass

■ HB-B75I1 ■ HB-B75L1

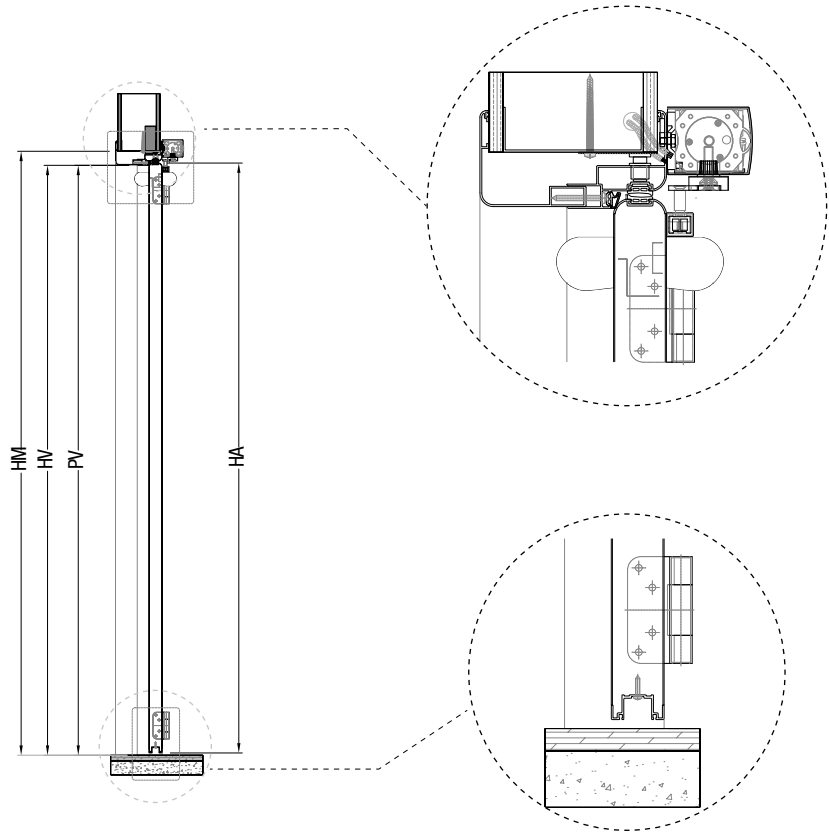
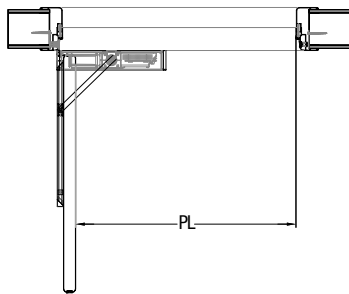
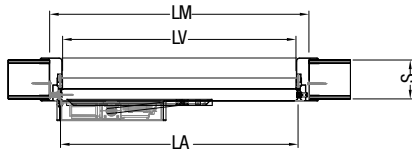
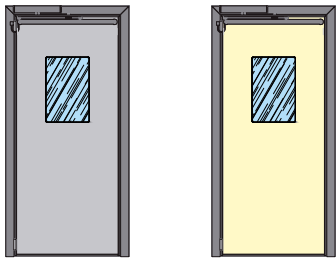

■ HB-B75V1

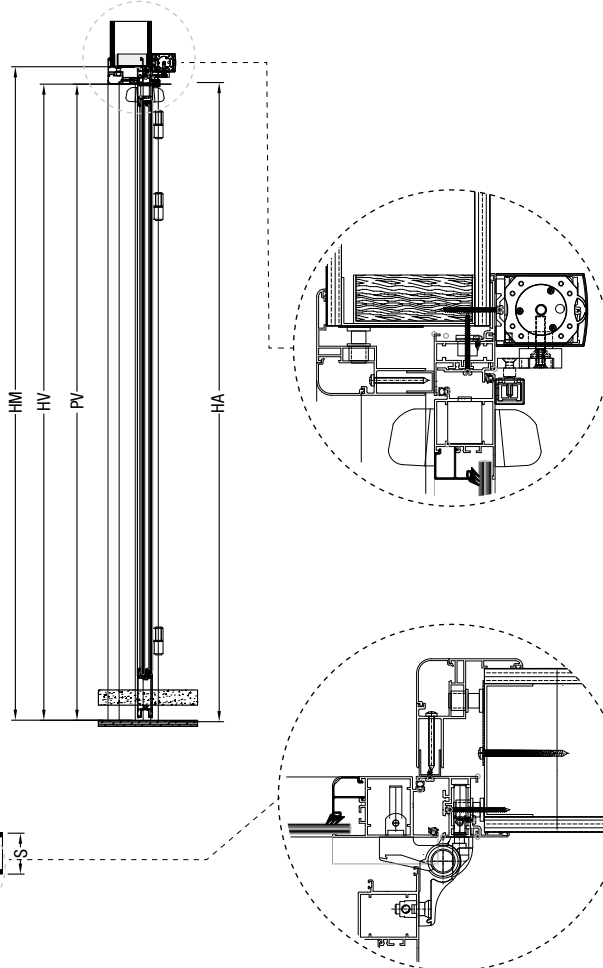
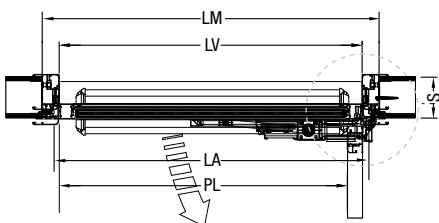
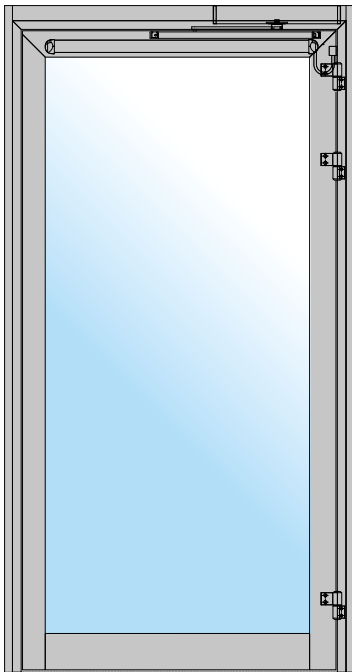

■ ■ ■ **Legenda / Key**

PL	Passaggio netto orizzontale <i>Horizontal net passage</i>
PV	Passaggio netto verticale <i>Vertical net passage</i>
LT	Lunghezza automazione <i>Automation length</i>
LM	Larghezza vano grezzo <i>Unfinished opening width</i>
LV	Larghezza vano finito <i>Finished opening width</i>
LA	Larghezza anta <i>Leaf width</i>
HM	Altezza vano grezzo <i>Unfinished opening height</i>
HV	Altezza vano finito <i>Finished opening height</i>
HA	Altezza anta <i>Leaf height</i>
S	Spessore muro <i>Wall thickness</i>



Porta automatica a battente a tenuta semplice - 2 ante
Automatic simple sealing swing door - 2 leaves

Tenuta semplice / Simple seal

2 ANTE / 2 LEAVES

AUTOMAZIONE NEXT 75 NEXT 75 AUTOMATION	HB-B75I2	HB-B75L2	HB-B75V2
	PANNELLO INOX STAINLESS STEEL PANEL	PANNELLO LAMINATO HPL PANEL	PANNELLO VETRO GLASS PANEL
LARGHEZZA VANO FINO A (LV) OPENING WIDTH UP TO (LV)			
1000 mm (39 ³ / ₈ "	HB-B75I2-1000	HB-B75L2-1000	HB-B75V2-1000
1200 mm (47 ¹ / ₄ "	HB-B75I2-1200	HB-B75L2-1200	HB-B75V2-1200
1400 mm (55 ¹ / ₈ "	HB-B75I2-1400	HB-B75L2-1400	HB-B75V2-1400
1600 mm (63"	HB-B75I2-1600	HB-B75L2-1600	HB-B75V2-1600
1800 mm (70 ⁷ / ₈ "	HB-B75I2-1800	HB-B75L2-1800	HB-B75V2-1800
2000 mm (78 ³ / ₄ "	HB-B75I2-2000	HB-B75L2-2000	HB-B75V2-2000

NOTA:
Per ogni tipologia di porta è necessario specificare l'apertura se "A SPINGERE" o "A TIRARE" con riferimento vista lato automazione.

NOTE:
For every type you must specify the type of opening, whether "PUSH" or "PULL", as seen from the operator side.

Elementi Opzionali da ordinare separatamente al momento dell'ordine
Optional items to be ordered separately at time of order

Colorazioni e finiture speciali Special colours and finishes	Fasce / Bands	Rivestimenti gruppo copertura Covering unit cladding	Visiva / Vision panel	Tendine elettriche e manuali Manual and electric blinds	Piombature Lead foils
pag./page 120	pag./page 103	pag./page 102	pag./page 96	pag./page 96	pag./page 104
Maniglie e maniglioni per porte scorrevoli Handle for Sliding Door	Maniglie per porte manuali a battente Level handle for manual swing door	Serrature Mechanical Lock	Dispositivi di impulso (se diversi da quelli standard) Pulse devices (if other than the standard ones)	Batterie di apertura in emergenza Emergency opening batteries	Imbotti e semi-imbotti Wall frame and semi-wall frame
pag./page 108	pag./page 109	pag./page 110	pag./page 117	pag./page 118	pag./page 100

■ Acciaio / ST.Steel

■ Laminato / HPL

■ Vetro / Glass

■ HB-B75I2

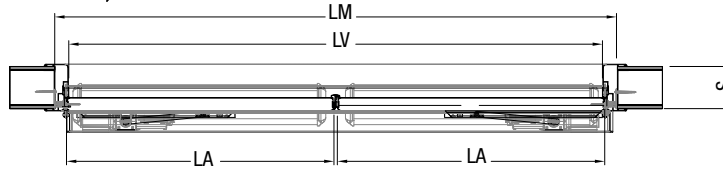
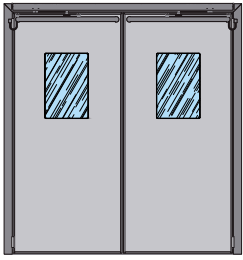

■ HB-B75L2

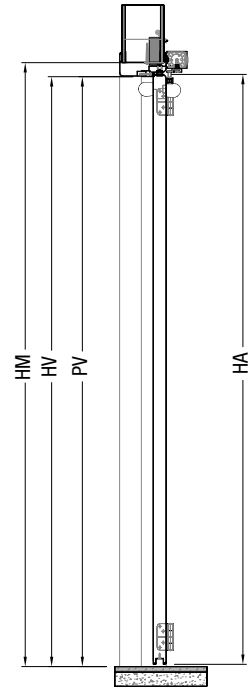
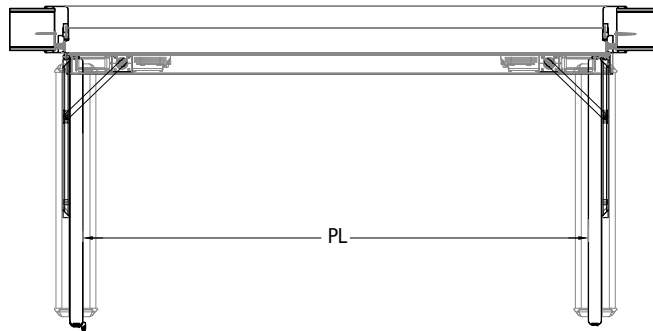
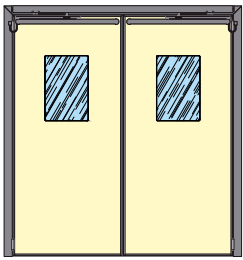

■ HB-B75V2

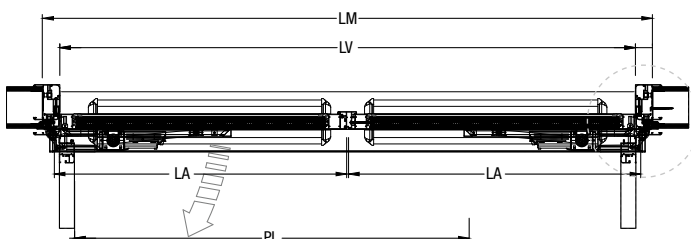
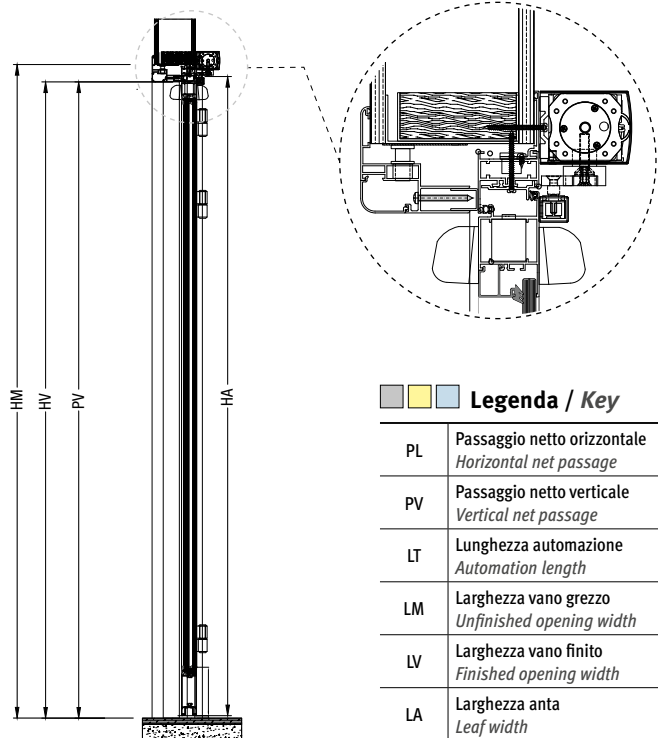
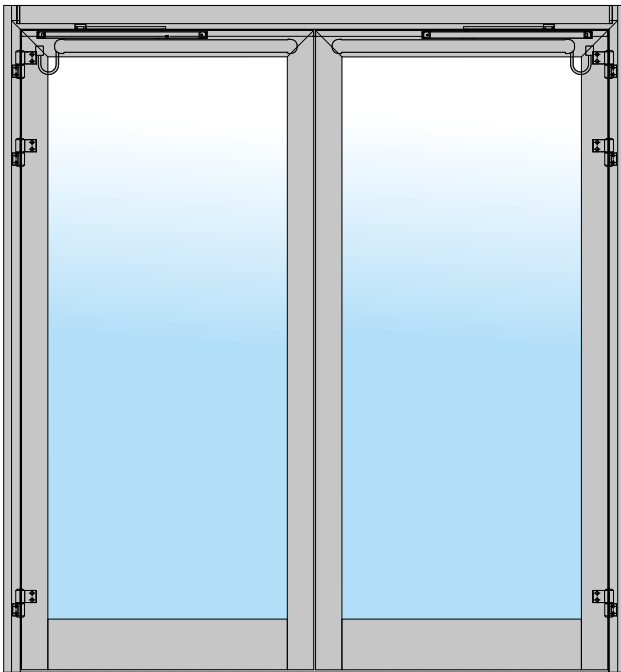

■ ■ ■ **Legenda / Key**

PL	Passaggio netto orizzontale <i>Horizontal net passage</i>
PV	Passaggio netto verticale <i>Vertical net passage</i>
LT	Lunghezza automazione <i>Automation length</i>
LM	Larghezza vano grezzo <i>Unfinished opening width</i>
LV	Larghezza vano finito <i>Finished opening width</i>
LA	Larghezza anta <i>Leaf width</i>
HM	Altezza vano grezzo <i>Unfinished opening height</i>
HV	Altezza vano finito <i>Finished opening height</i>
HA	Altezza anta <i>Leaf height</i>
S	Spessore muro <i>Wall thickness</i>



Porta automatica a battente asimmetrica a tenuta semplice - 2 ante
Simple sealing asymmetric automatic swing door - 2 leaves

Tenuta semplice / Simple seal

2 ANTE / 2 LEAVES

AUTOMAZIONE NEXT 75 NEXT 75 AUTOMATION	HB-B75I2A	HB-B75L2A	HB-B75V2A
	PANNELLO INOX STAINLESS STEEL PANEL	PANNELLO LAMINATO HPL PANEL	PANNELLO VETRO GLASS PANEL
LARGHEZZA VANO FINO A (LV) OPENING WIDTH UP TO (LV)			
1000 mm (39 ³ / ₈ "	-	-	HB-B75V2A-1000
1200 mm (47 ¹ / ₄ "	HB-B75I2A-1200	HB-B75L2A-1200	HB-B75V2A-1200
1400 mm (55 ¹ / ₈ "	HB-B75I2A-1400	HB-B75L2A-1400	HB-B75V2A-1400
1600 mm (63"	HB-B75I2A-1600	HB-B75L2A-1600	HB-B75V2A-1600

NOTA:
Per ogni tipologia di porta è necessario specificare l'apertura se "A SPINGERE" o "A TIRARE"
con riferimento vista lato automazione.
Larghezza max. anta motorizzata = 1000 mm - Larghezza min. anta manuale = 300 mm

NOTE:
For every type you must specify the type of opening, whether "PUSH" or "PULL", as seen from the operator side.
"Master" leaf max. width = 1000 mm (39³/₈") - "slave" leaf min. width = 300 mm (11³/₈").

Elementi Opzionali da ordinare separatamente al momento dell'ordine
Optional items to be ordered separately at time of order

Colorazioni e finiture speciali Special colours and finishes	Fasce / Bands	Rivestimenti gruppo copertura Covering unit cladding	Visiva / Vision panel	Tendine elettriche e manuali Manual and electric blinds	Piombature Lead foils
pag./page 120	pag./page 103	pag./page 102	pag./page 96	pag./page 96	pag./page 104
Maniglie e maniglioni per porte scorrevoli Handle for Sliding Door	Maniglie per porte manuali a battente Level handle for manual swing door	Serrature Mechanical Lock	Dispositivi di impulso (se diversi da quelli standard) Pulse devices (if other than the standard ones)	Batterie di apertura in emergenza Emergency opening batteries	Imbotti e semi-imbotti Wall frame and semi-wall frame
pag./page 108	pag./page 109	pag./page 110	pag./page 117	pag./page 118	pag./page 100

■ Acciaio / ST. Steel ■ Laminato / HPL ■ Vetro / Glass

■ HB-B75I2A

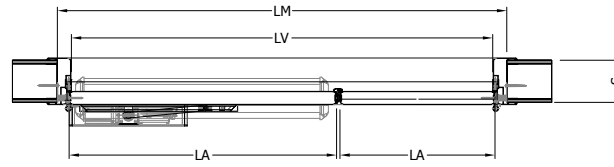
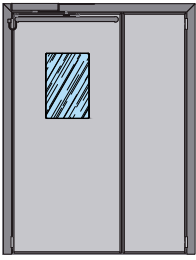

■ HB-B75L2A

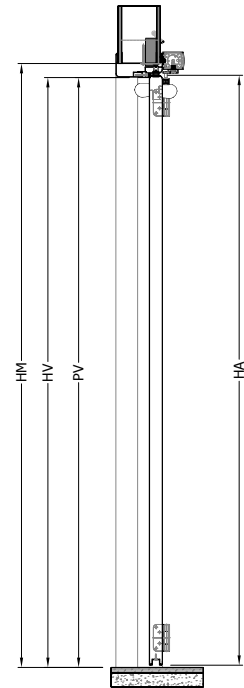
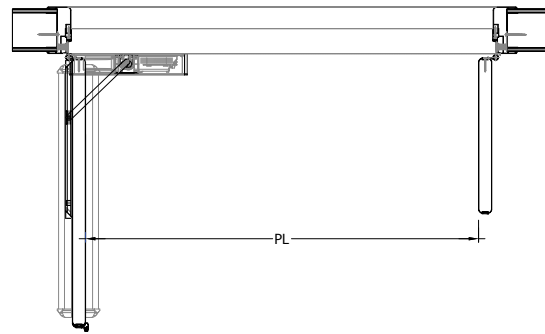
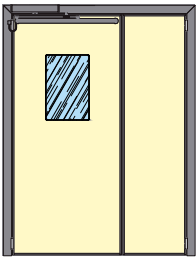

■ HB-B75V2A

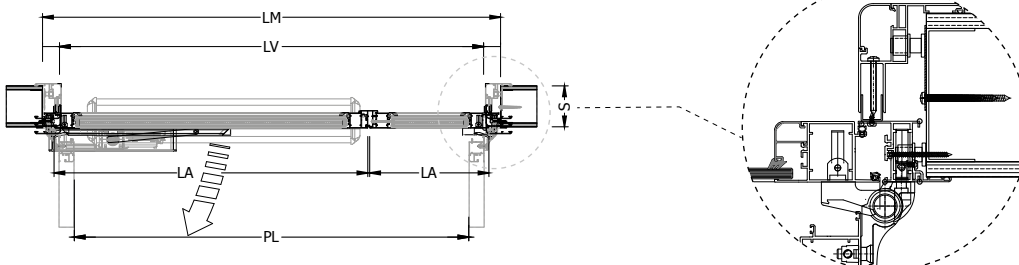
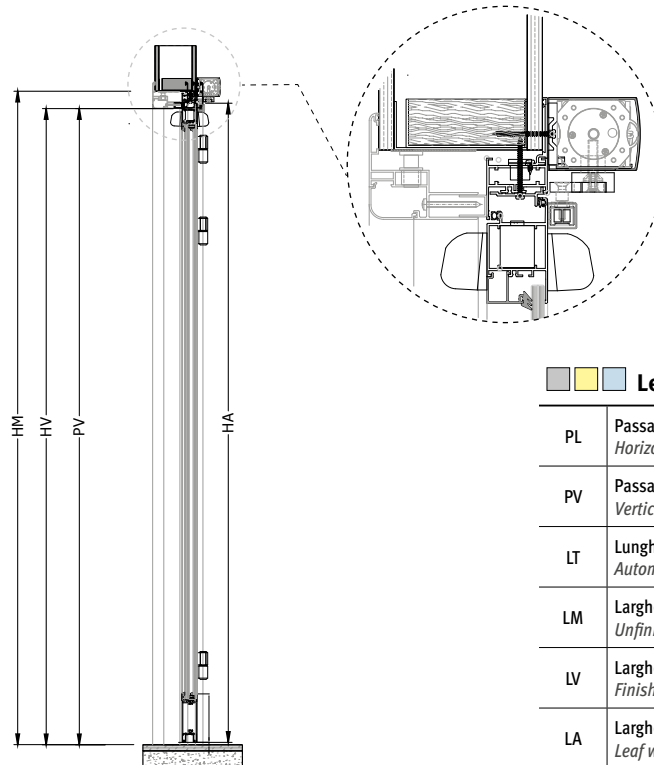
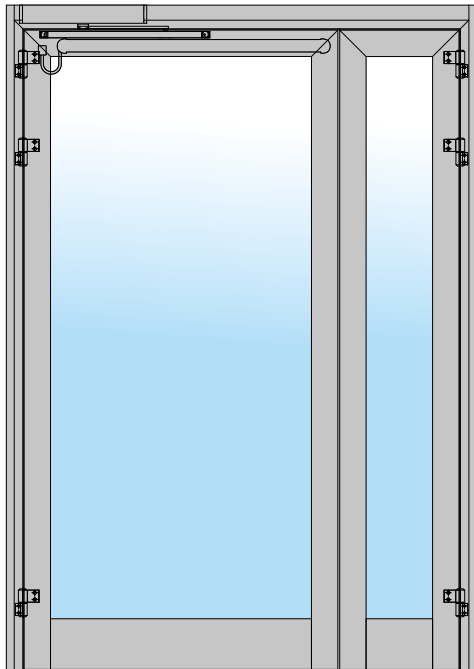

■ ■ ■ **Legenda / Key**

PL	Passaggio netto orizzontale <i>Horizontal net passage</i>
PV	Passaggio netto verticale <i>Vertical net passage</i>
LT	Lunghezza automazione <i>Automation length</i>
LM	Larghezza vano grezzo <i>Unfinished opening width</i>
LV	Larghezza vano finito <i>Finished opening width</i>
LA	Larghezza anta <i>Leaf width</i>
HM	Altezza vano grezzo <i>Unfinished opening height</i>
HV	Altezza vano finito <i>Finished opening height</i>
HA	Altezza anta <i>Leaf height</i>
S	Spessore muro <i>Wall thickness</i>

PORTE AUTOMATICHE A BATTENTE A TENUTA SEMPLICE

Porte "TECNICHE" destinate a sale operatorie, laboratori, ambulatori e ambienti altamente asettici in genere, per uso intensivo e delta pressione uguale o inferiore a 15 Pa.

La porta in versione automatica è fornita con telaio a muro porta cerniere, predisposto per il montaggio su mazzetta a muro o controtelaio e può essere completata con accessori quale visiva, maniglia, fascia paracolpi, dispositivi di impulso e sensori di sicurezza (radar, sensori a raggi infrarossi). La tenuta è garantita da guarnizioni in EPDM espanse montate sui profili in alluminio che coprono tre lati del perimetro dell'anta.

Nella parte inferiore è installata, di serie, una spazzola in setole rigide e, su richiesta, un kit per tenuta ermetica.

Automazione

- Automazione mod. NEXT 150 per porte a battente, apertura e chiusura a motore per anta larghezza massima 1200 mm.
- Peso massimo per anta: kg 150 (fino a 1000 mm).
- Dimensioni automazione (HxPxL) 60x75x420 mm.
- Adatta per ambienti in cui la pressione dell'aria filtrata introdotta dagli impianti di ventilazione non supera 15Pa.

AUTOMATIC SIMPLE SEALING SWING DOORS







"TECHNICAL" doors designed for operating rooms, laboratories, clinics, and highly aseptic environments in general, for intensive use and delta pressure not exceeding 15 Pa.







The automatic version of the door comes with a wall frame equipped for hinges, ready to be mounted on wall rabbets or on a subframe. It can be supplemented with the following accessories: vision panel, handle, bump band, pulse devices and safety sensors (radar, infrared sensors). Tightness is provided by expanded EPDM gaskets mounted on the aluminium profiles that cover three sides of the leaf perimeter.

A rigid-bristle brush is installed on the bottom edge and an hermetic seal kit is available on request.

Automation

- NEXT 150 automation model for swing doors, motorized opening and closing, for a leaf with maximum width of 1200 mm (47 $\frac{1}{4}$ ").
- Maximum weight for each leaf: 250 kg (551lb) (up to 1000 mm - 39 $\frac{3}{8}$ ").
- Automation dimensions (HxDxL) 60x75x420 mm (2 $\frac{3}{8}$ " x 2 $\frac{15}{16}$ " x 16 $\frac{9}{16}$ ").
- Suitable for environments where the filtered air pressure introduced by ventilation systems does not exceed 15Pa.

Pannelli	Inclusi
	Automazione NEXT 150: <ul style="list-style-type: none"> • Automazione elettromeccanica per uso intensivo • Copertura in alluminio colore argento anodizzato naturale - H.60 mm • Base supporto in alluminio • Fianchetti in ABS grigi • Alimentazione a 115/230Vac - 50/60Hz • Motore brushless con encoder incorporato ad elevate prestazioni, bassa usura e consumi ridotti • Sistema di trasmissione movimento tramite ingranaggi a ruote dentate estremamente silenzioso • Batteria incorporata nella versione NEXT 150B
	Pannello anta completo di cornici e guarnizioni dedicate
	Anta completa di profili, vetro 44.2 e guarnizioni dedicate
	Gruppo copertura in alluminio
	Braccio a tirare HB-NEXTBDT o a spingere NEXT-BAS
	Programmatore digitale e sensori di sicurezza

Panels	Includes
	Automation NEXT 150: <ul style="list-style-type: none"> • Heavy-duty electromechanical automation • Aluminium cover in natural anodized-silver colour - H.60 mm (2$\frac{3}{8}$"). • Aluminium support base • Grey ABS side caps • 115/230Vac - 50/60Hz power supply • Brushless motor with built-in encoder, featuring high performance, low wear, low power consumption • Very quiet gear-driven motion transmission system • Built-in battery in version NEXT 150B
	Leaf panel complete with dedicated frames and gaskets
	Leaf complete with profiles, 44.2 or 8 mm ($\frac{5}{16}$ ") glazing, and dedicated gaskets
	Aluminium covering unit in HPL version
	Pull arm HB-NEXTBDT or push arm NEXT-BAS
	Digital selector and safety sensors

PORTE AUTOMATICHE A BATTENTE A TENUTA SEMPLICE AUTOMATIC SIMPLE SEALING SWING DOORS

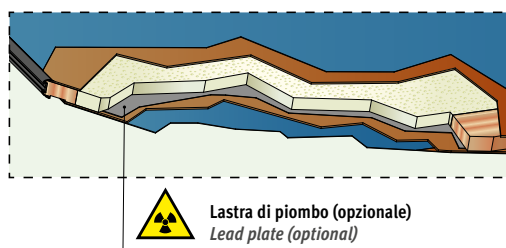
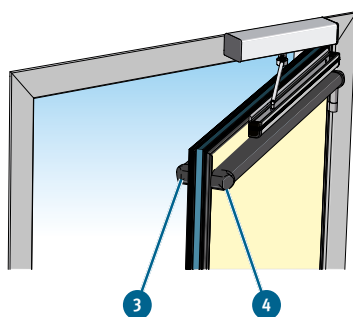

Esempio automazione
Con braccio "a tirare"
Example of automation with
"Pull arm"

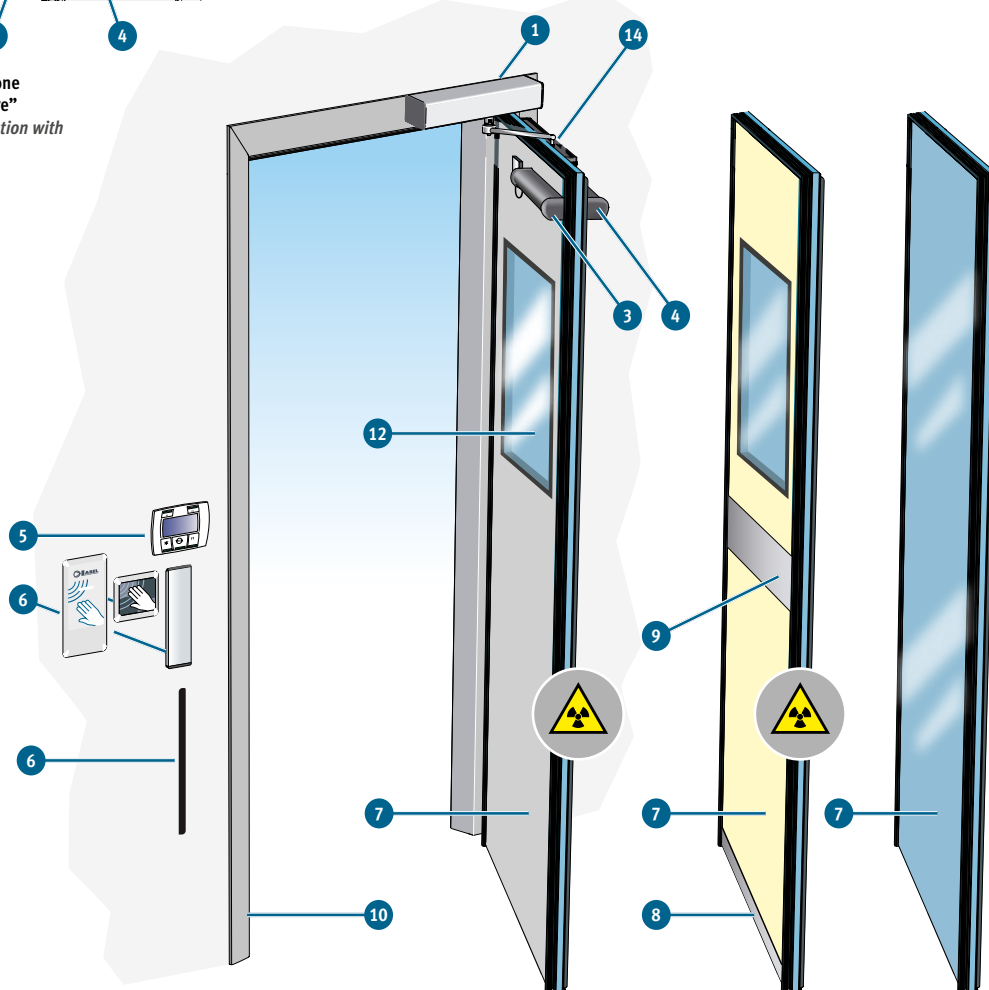

Legenda / Key

- | | |
|---|---|
| 1 Gruppo automazione / Automation unit | 8 Zoccolo / Base |
| 3 Sensore di sicurezza lato chiusura / Closing-side safety sensor | 9 Fascia orizzontale / Horizontal band |
| 4 Sensore di sicurezza lato apertura / Opening-side safety sensor | 10 Telaio / Frame |
| 5 Programmatore digitale / Digital programmer | 12 Visiva (opzionale) / Vision panel (optional) |
| 6 Dispositivi di attivazione / Activation devices | 14 Braccio (a tirare o a spingere) / Arm (pull or push) |
| 7 Pannello / Panel | |



• Misurazione in laboratorio isolamento acustico n° 297957 (misurazione isolamento acustico sui pannelli effettuata con metodo empirico).

• Laboratory measurement of sound insulation no. 297957 (measurement of panel sound insulation performed using the empirical method).



Porta automatica a battente a tenuta semplice - 1 anta
Automatic simple sealing swing door - 1 leaf

Tenuta semplice / Simple seal

1 ANTA / 1 LEAF

AUTOMAZIONE NEXT 150 NEXT 150 AUTOMATION	HB-B150I1	HB-B150L1	HB-B150V1
	PANNELLO INOX STAINLESS STEEL PANEL	PANNELLO LAMINATO HPL PANEL	PANNELLO VETRO GLASS PANEL
LARGHEZZA VANO FINO A (LV) OPENING WIDTH UP TO (LV)			
800 mm (31½")	HB-B150I1-800	HB-B150L1-800	HB-B150V1-800
900 mm (35¼")	HB-B150I1-900	HB-B150L1-900	HB-B150V1-900
1000 mm (39¾")	HB-B150I1-1000	HB-B150L1-1000	HB-B150V1-1000
1100 mm (43⅝")	HB-B150I1-1100	HB-B150L1-1100	HB-B150V1-1100
1200 mm (47¼")	HB-B150I1-1200	HB-B150L1-1200	HB-B150V1-1200

NOTA: Per ogni tipologia di porta è necessario specificare l'apertura se "A SPINGERE" o "A TIRARE" con riferimento vista lato automazione.
NOTE: For every type you must specify the type of opening, whether "PUSH" or "PULL", as seen from the operator side.

	HB-B150I1 - HB-B150L1	
	Kit trasformazione a tenuta ermetica con elettromagnete <i>Hermetic seal conversion kit with maglock</i>	H-KBEA1
	Elettromagnete <i>Maglock</i>	
	Guarnizione mobile a pavimento <i>Drop seal</i>	
		Guarnizione perimetrale <i>Perimeter seal</i>

Elementi Opzionali da ordinare separatamente al momento dell'ordine
Optional items to be ordered separately at time of order

Colorazioni e finiture speciali <i>Special colours and finishes</i>	Fasce / Bands	Rivestimenti gruppo copertura <i>Covering unit cladding</i>	Visiva / Vision panel	Tendine elettriche e manuali <i>Manual and electric blinds</i>	Piombature <i>Lead foils</i>
pag./page 120	pag./page 103	pag./page 102	pag./page 96	pag./page 96	pag./page 104
Maniglie e maniglioni per porte scorrevoli <i>Handle for Sliding Door</i>	Maniglie per porte manuali a battente <i>Level handle for manual swing door</i>	Serrature <i>Mechanical Lock</i>	Dispositivi di impulso (se diversi da quelli standard) <i>Pulse devices (if other than the standard ones)</i>	Batterie di apertura in emergenza <i>Emergency opening batteries</i>	Imbotti e semi-imbotti <i>Wall frame and semi-wall frame</i>
pag./page 108	pag./page 109	pag./page 110	pag./page 117	pag./page 118	pag./page 100

■ Acciaio / ST. Steel ■ Laminato / HPL ■ Vetro / Glass

■ HB-B150I1 ■ HB-B150L1

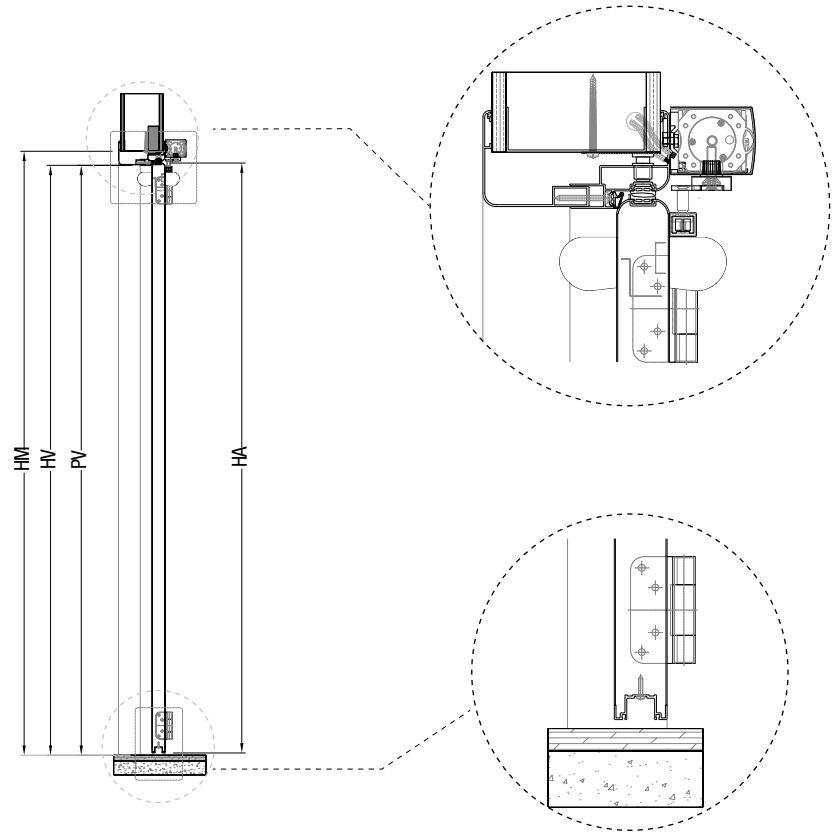
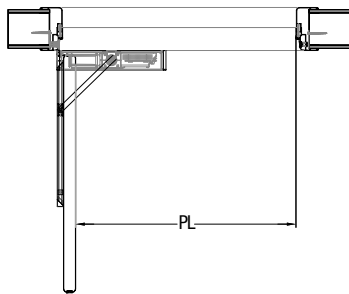
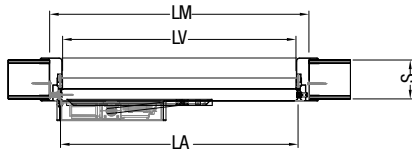
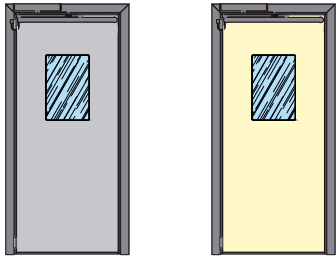

■ HB-B150V1

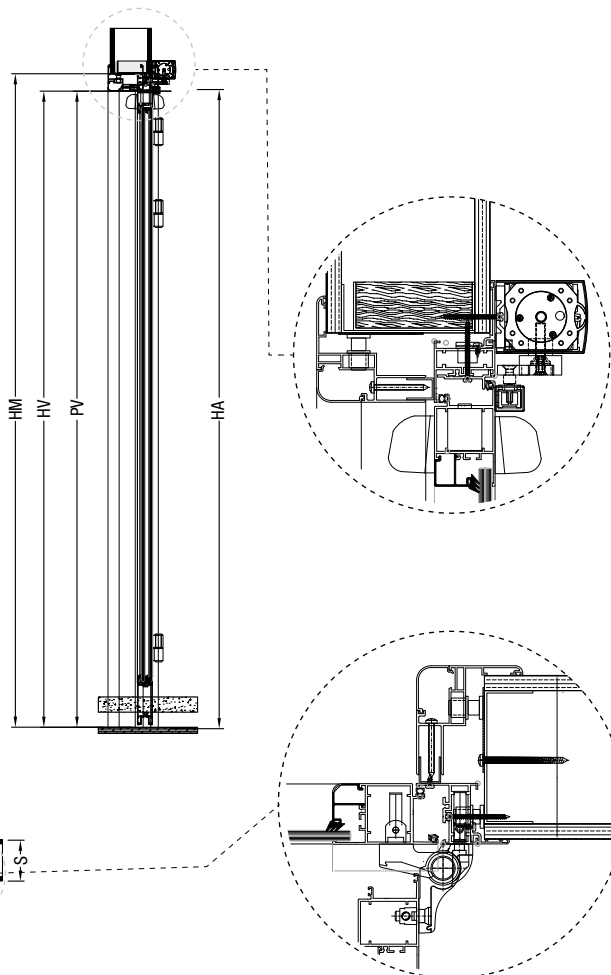
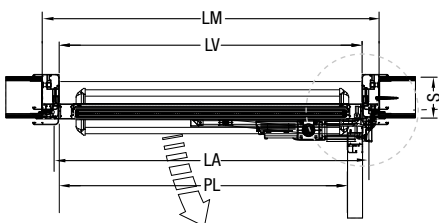
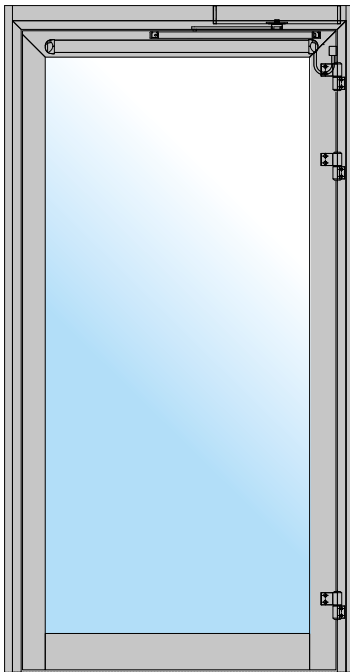

■ ■ ■ **Legenda / Key**

PL	Passaggio netto orizzontale <i>Horizontal net passage</i>
PV	Passaggio netto verticale <i>Vertical net passage</i>
LT	Lunghezza automazione <i>Automation length</i>
LM	Larghezza vano grezzo <i>Unfinished opening width</i>
LV	Larghezza vano finito <i>Finished opening width</i>
LA	Larghezza anta <i>Leaf width</i>
HM	Altezza vano grezzo <i>Unfinished opening height</i>
HV	Altezza vano finito <i>Finished opening height</i>
HA	Altezza anta <i>Leaf height</i>
S	Spessore muro <i>Wall thickness</i>



Porta automatica a battente a tenuta semplice - 2 ante
Automatic simple sealing swing door - 2 leaves

Tenuta semplice / Simple seal

2 ANTE / 2 LEAVES

AUTOMAZIONE NEXT 150 NEXT 150 AUTOMATION	HB-B150I2	HB-B150L2	HB-B150V2
	PANNELLO INOX STAINLESS STEEL PANEL	PANNELLO LAMINATO HPL PANEL	PANNELLO VETRO GLASS PANEL
LARGHEZZA VANO FINO A (LV) OPENING WIDTH UP TO (LV)			
1000 mm (39 3/8")	HB-B150I2-1000	HB-B150L2-1000	HB-B150V2-1000
1200 mm (47 1/4")	HB-B150I2-1200	HB-B150L2-1200	HB-B150V2-1200
1400 mm (55 1/8")	HB-B150I2-1400	HB-B150L2-1400	HB-B150V2-1400
1600 mm (63")	HB-B150I2-1600	HB-B150L2-1600	HB-B150V2-1600
1800 mm (70 7/8")	HB-B150I2-1800	HB-B150L2-1800	HB-B150V2-1800
2000 mm (78 3/4")	HB-B150I2-2000	HB-B150L2-2000	HB-B150V2-2000

NOTA: Per ogni tipologia di porta è necessario specificare l'apertura se "A SPINGERE" o "A TIRARE" con riferimento vista lato automazione.
NOTE: For every type you must specify the type of opening, whether "PUSH" or "PULL", as seen from the operator side.

	HB-B150I2 - HB-B150L2	
	Kit trasformazione a tenuta ermetica con elettromagnete <i>Hermetic seal conversion kit with maglock</i>	H-KBEA2
	Elettromagnete <i>Maglock</i>	
	Guarnizione mobile a pavimento <i>Drop seal</i>	
		Guarnizione perimetrale <i>Perimeter seal</i>

Elementi Opzionali da ordinare separatamente al momento dell'ordine
Optional items to be ordered separately at time of order

Colorazioni e finiture speciali <i>Special colours and finishes</i>	Fasce / Bands	Rivestimenti gruppo copertura <i>Covering unit cladding</i>	Visiva / Vision panel	Tendine elettriche e manuali <i>Manual and electric blinds</i>	Piombature <i>Lead foils</i>
pag./page 120	pag./page 103	pag./page 102	pag./page 96	pag./page 96	pag./page 104
Maniglie e maniglioni per porte scorrevoli <i>Handle for Sliding Door</i>	Maniglie per porte manuali a battente <i>Level handle for manual swing door</i>	Serrature <i>Mechanical Lock</i>	Dispositivi di impulso (se diversi da quelli standard) <i>Pulse devices (if other than the standard ones)</i>	Batterie di apertura in emergenza <i>Emergency opening batteries</i>	Imbotti e semi-imbotti <i>Wall frame and semi-wall frame</i>
pag./page 108	pag./page 109	pag./page 110	pag./page 117	pag./page 118	pag./page 100

■ Acciaio / ST.Steel ■ Laminato / HPL ■ Vetro / Glass

■ HB-B150I2

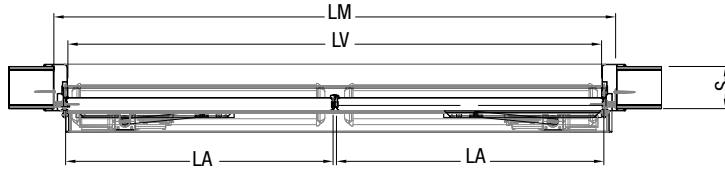
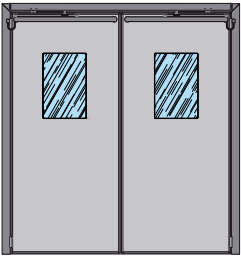

■ HB-B150L2

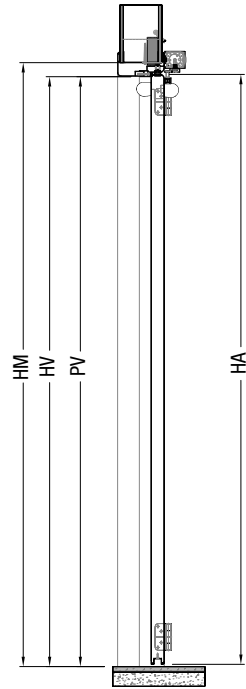
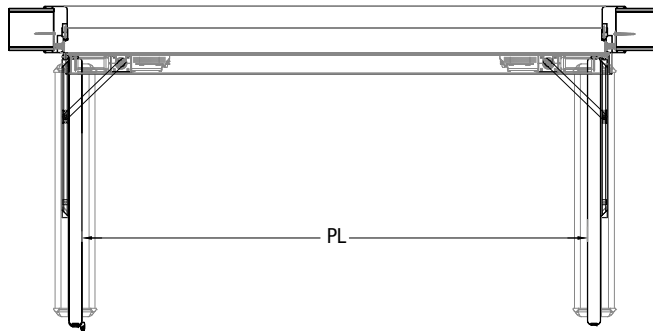
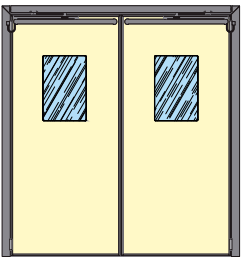

■ HB-B150V2

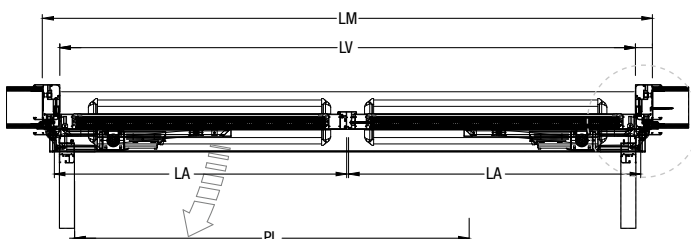
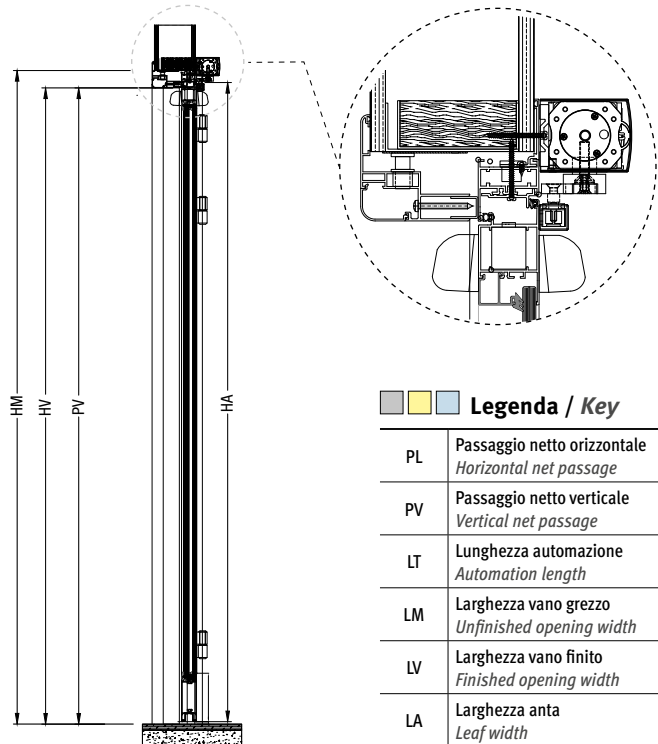
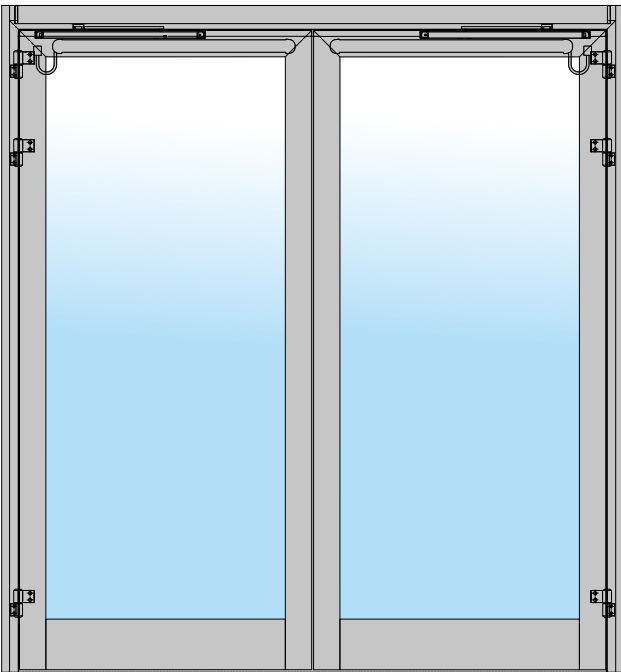

■ ■ ■ **Legenda / Key**

PL	Passaggio netto orizzontale <i>Horizontal net passage</i>
PV	Passaggio netto verticale <i>Vertical net passage</i>
LT	Lunghezza automazione <i>Automation length</i>
LM	Larghezza vano grezzo <i>Unfinished opening width</i>
LV	Larghezza vano finito <i>Finished opening width</i>
LA	Larghezza anta <i>Leaf width</i>
HM	Altezza vano grezzo <i>Unfinished opening height</i>
HV	Altezza vano finito <i>Finished opening height</i>
HA	Altezza anta <i>Leaf height</i>
S	Spessore muro <i>Wall thickness</i>



Porta automatica a battente asimmetrica a tenuta semplice - 2 ante
Simple sealing asymmetric automatic swing door - 2 leaves

Tenuta semplice / Simple seal

2 ANTE / 2 LEAVES

AUTOMAZIONE NEXT 150 NEXT 150 AUTOMATION	HB-B150I2A	HB-B150L2A	HB-B150V2A	
	PANNELLO INOX STAINLESS STEEL PANEL	PANNELLO LAMINATO HPL PANEL	PANNELLO VETRO GLASS PANEL	
LARGHEZZA VANO FINO A (LV) OPENING WIDTH UP TO (LV)				
			€	
1000 mm (39 3/8")	-	-	-	HB-B150V2A-1000
1200 mm (47 1/4")	HB-B150I2A-1200	HB-B150L2A-1200	6.950,00	HB-B150V2A-1200
1400 mm (55 1/8")	HB-B150I2A-1400	HB-B150L2A-1400	7.050,00	HB-B150V2A-1400
1600 mm (63")	HB-B150I2A-1600	HB-B150L2A-1600	7.150,00	HB-B150V2A-1600
1800 mm (70 7/8")	HB-B150I2A-1800	HB-B150L2A-1800	7.250,00	HB-B150V2A-1800
2000 mm (78 3/4")	HB-B150I2A-2000	HB-B150L2A-2000	7.400,00	HB-B150V2A-2000

NOTA: Per ogni tipologia di porta è necessario specificare l'apertura se "A SPINGERE" o "A TIRARE" con riferimento vista lato automazione.
Larghezza max. anta motorizzata = 1200 mm - Larghezza min. anta manuale = 300 mm

NOTE: For every type you must specify the type of opening, whether "PUSH" or "PULL", as seen from the operator side.
"Master" leaf max. width = 1200 mm (47 1/4") - "slave" leaf min. width = 300 mm (11 3/4")

	HB-B150I2A - HB-B150L2A	
	Kit trasformazione a tenuta ermetica <i>Hermetic seal conversion kit</i>	H-KBEM1
	Kit trasformazione a tenuta ermetica con elettromagnete <i>Hermetic seal conversion kit with maglock</i>	H-KBEA1
	Elettromagnete <i>Maglock</i>	
	Guarnizione mobile a pavimento <i>Drop seal</i>	
		Guarnizione perimetrale <i>Perimeter seal</i>

Elementi Opzionali da ordinare separatamente al momento dell'ordine
Optional items to be ordered separately at time of order

Colorazioni e finiture speciali <i>Special colours and finishes</i>	Fasce / Bands	Rivestimenti gruppo copertura <i>Covering unit cladding</i>	Visiva / Vision panel	Tendine elettriche e manuali <i>Manual and electric blinds</i>	Piombature <i>Lead foils</i>
pag./page 120	pag./page 103	pag./page 102	pag./page 96	pag./page 96	pag./page 104
Maniglie e maniglioni per porte scorrevoli <i>Handle for Sliding Door</i>	Maniglie per porte manuali a battente <i>Level handle for manual swing door</i>	Serrature <i>Mechanical Lock</i>	Dispositivi di impulso (se diversi da quelli standard) <i>Pulse devices (if other than the standard ones)</i>	Batterie di apertura in emergenza <i>Emergency opening batteries</i>	Imbotti e semi-imbotti <i>Wall frame and semi-wall frame</i>
pag./page 108	pag./page 109	pag./page 110	pag./page 117	pag./page 118	pag./page 100

■ Acciaio / ST. Steel ■ Laminato / HPL ■ Vetro / Glass

■ HB-B150I2A

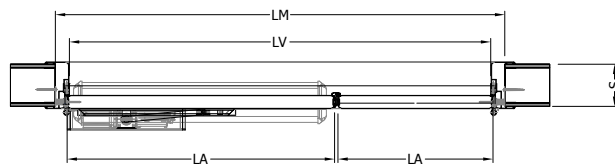
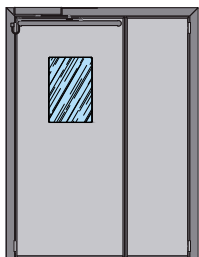

■ HB-B150L2A

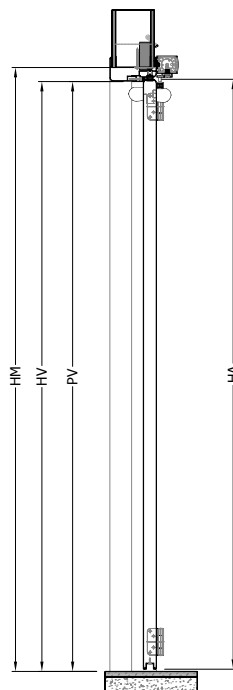
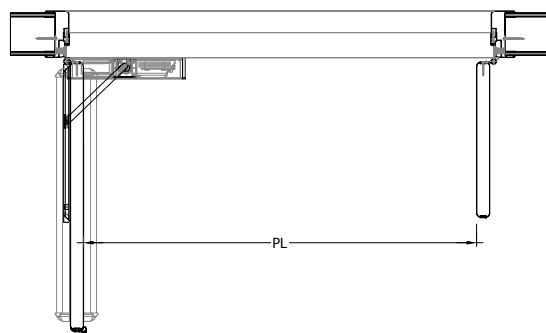
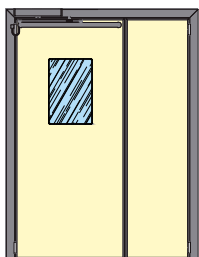

■ HB-B150V2A

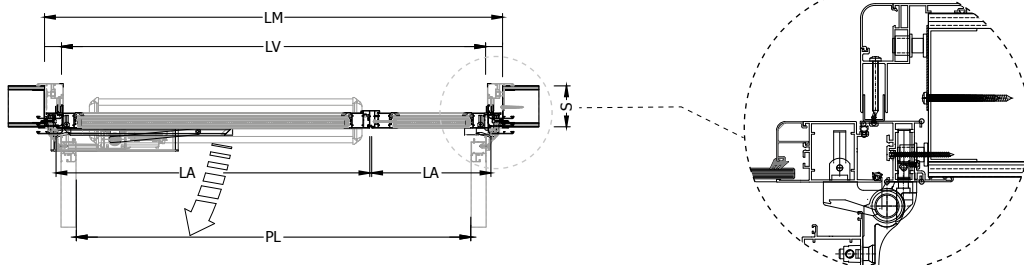
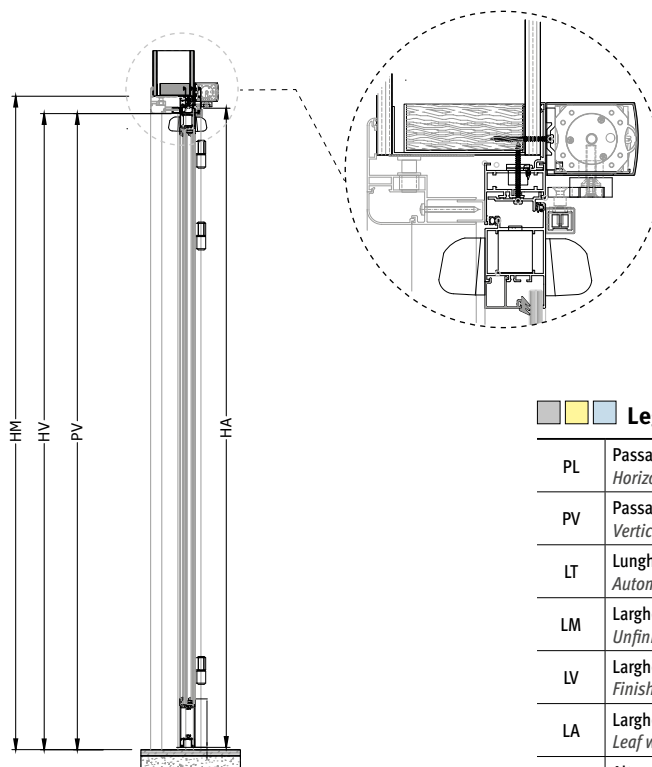
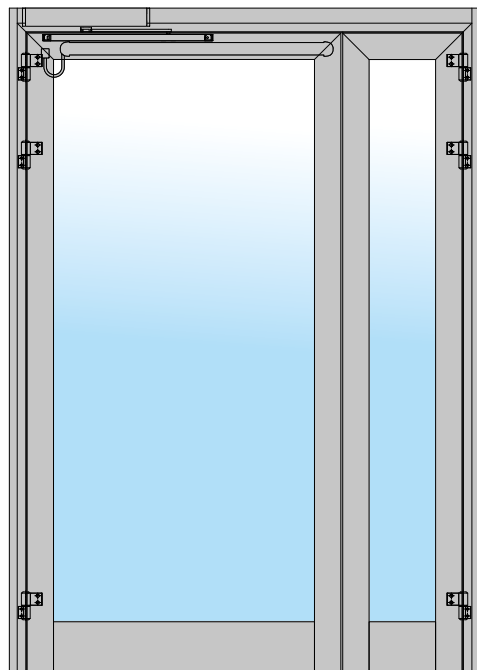

■ ■ ■ **Legenda / Key**

PL	Passaggio netto orizzontale <i>Horizontal net passage</i>
PV	Passaggio netto verticale <i>Vertical net passage</i>
LT	Lunghezza automazione <i>Automation length</i>
LM	Larghezza vano grezzo <i>Unfinished opening width</i>
LV	Larghezza vano finito <i>Finished opening width</i>
LA	Larghezza anta <i>Leaf width</i>
HM	Altezza vano grezzo <i>Unfinished opening height</i>
HV	Altezza vano finito <i>Finished opening height</i>
HA	Altezza anta <i>Leaf height</i>
S	Spessore muro <i>Wall thickness</i>



Porta automatica a battente con lastre in piombo - 1 anta
Automatic swing door with lead plates - 1 leaf

Tenuta semplice - PB / Simple seal - PB

1 ANTA / 1 LEAF

AUTOMAZIONE NEXT 150 NEXT 150 AUTOMATION		PANNELLO INOX STAINLESS STEEL PANEL	PANNELLO LAMINATO HPL PANEL
LASTRA DI PIOMBO LEAD PLATE	LARGHEZZA VANO FINO A (LV) OPENING WIDTH UP TO (LV)		
Pb 1 mm (1/16")	800 mm (31 1/2")	HB-B150I1-800 1PB	HB-B150L1-800 1PB
Pb 1 mm (1/16")	900 mm (35 3/16")	HB-B150I1-900 1PB	HB-B150L1-900 1PB
Pb 1 mm (1/16")	1000 mm (39 3/8")	HB-B150I1-1000 1PB	HB-B150L1-1000 1PB
Pb 1 mm (1/16")	1100 mm (43 3/16")	HB-B150I1-1100 1PB	HB-B150L1-1100 1PB
Pb 1 mm (1/16")	1200 mm (47 1/4")	HB-B150I1-1200 1PB	HB-B150L1-1200 1PB
Pb 2 mm (1/8")	800 mm (31 1/2")	HB-B150I1-800 2PB	HB-B150L1-800 2PB
Pb 2 mm (1/8")	900 mm (35 3/16")	HB-B150I1-900 2PB	HB-B150L1-900 2PB
Pb 2 mm (1/8")	1000 mm (39 3/8")	HB-B150I1-1000 2PB	HB-B150L1-1000 2PB
Pb 2 mm (1/8")	1100 mm (43 3/16")	HB-B150I1-1100 2PB	HB-B150L1-1100 2PB
Pb 2 mm (1/8")	1200 mm (47 1/4")	HB-B150I1-1200 2PB	HB-B150L1-1200 2PB

NOTA: Per ogni tipologia di porta è necessario specificare l'apertura se "A SPINGERE" o "A TIRARE" con riferimento vista lato automazione.

NOTE: For every type you must specify the type of opening, whether "PUSH" or "PULL", as seen from the operator side.

KIT	
Kit trasformazione a tenuta ermetica con elettromagnete <i>Hermetic seal conversion kit with maglock</i>	H-KBEA1

IMPORTANTE: La lastra di piombo è presente solo nel pannello e nel telaio. L'imbotte o l'estensione imbotte (se previste nella fornitura) non sono MAI dotate di lastra di piombo. Schermatura del muro/parete non di competenza LABEL.

IMPORTANT: The lead plate is present in the panel and the frame only. The wall frame or wall frame extension (if provided for in the supply) is NEVER equipped with a lead plate. Wall protection not in LABEL scope.



HB-B150I2-PB
HB-B150L2-PB

PORTE AUTOMATICHE A BATTENTE CON LASTRE IN PIOMBO
AUTOMATIC SWING DOORS WITH LEAD PLATES



Porta automatica a battente con lastre in piombo - 2 ante
Automatic swing door with lead plates - 2 leaves

AUTOMAZIONE NEXT 150 NEXT 150 AUTOMATION		PANNELLO INOX STAINLESS STEEL PANEL	PANNELLO LAMINATO HPL PANEL
LASTRA DI PIOMBO LEAD PLATE	LARGHEZZA VANO FINO A (LV) OPENING WIDTH UP TO (LV)		
Pb 1 mm (1/16")	1000 mm (39 3/8")	HB-B150I2-1000 1PB	HB-B150L2-1000 1PB
Pb 1 mm (1/16")	1200 mm (47 1/4")	HB-B150I2-1200 1PB	HB-B150L2-1200 1PB
Pb 1 mm (1/16")	1400 mm (55 1/8")	HB-B150I2-1400 1PB	HB-B150L2-1400 1PB
Pb 1 mm (1/16")	1600 mm (63")	HB-B150I2-1600 1PB	HB-B150L2-1600 1PB
Pb 1 mm (1/16")	1800 mm (70 7/8")	HB-B150I2-1800 1PB	HB-B150L2-1800 1PB
Pb 1 mm (1/16")	2000 mm (78 3/4")	HB-B150I2-2000 1PB	HB-B150L2-2000 1PB
Pb 2 mm (1/8")	1000 mm (39 3/8")	HB-B150I2-1000 2PB	HB-B150L2-1000 2PB
Pb 2 mm (1/8")	1200 mm (47 1/4")	HB-B150I2-1200 2PB	HB-B150L2-1200 2PB
Pb 2 mm (1/8")	1400 mm (55 1/8")	HB-B150I2-1400 2PB	HB-B150L2-1400 2PB
Pb 2 mm (1/8")	1600 mm (63")	HB-B150I2-1600 2PB	HB-B150L2-1600 2PB
Pb 2 mm (1/8")	1800 mm (70 7/8")	HB-B150I2-1800 2PB	HB-B150L2-1800 2PB
Pb 2 mm (1/8")	2000 mm (78 3/4")	HB-B150I2-2000 2PB	HB-B150L2-2000 2PB

NOTA: Per ogni tipologia di porta è necessario specificare l'apertura se "A SPINGERE" o "A TIRARE" con riferimento vista lato automazione.

NOTE: For every type you must specify the type of opening, whether "PUSH" or "PULL", as seen from the operator side.

KIT	
Kit trasformazione a tenuta ermetica con elettromagnete <i>Hermetic seal conversion kit with maglock</i>	H-KBEA2

IMPORTANTE: La lastra di piombo è presente solo nel pannello e nel telaio. L'imbotte o l'estensione imbotte (se previste nella fornitura) non sono MAI dotate di lastra di piombo. Schermatura del muro/parete non di competenza LABEL.

IMPORTANT: The lead plate is present in the panel and the frame only. The wall frame or wall frame extension (if provided for in the supply) is NEVER equipped with a lead plate. Wall protection not in LABEL scope.

Tenuta semplice - PB / Simple seal - PB

2 ANTE / 2 LEAVES



HB-B150I2A-PB
HB-B150L2A-PB

PORTE AUTOMATICHE A BATTENTE ASIMMETRICHE CON LASTRE IN PIOMBO
AUTOMATIC ASYMMETRICAL SWING DOORS WITH LEAD PLATES



Porta automatica a battente asimmetrica con lastre in piombo - 2 ante
Automatic asymmetrical swing door with lead plates - 2 leaves

Tenuta semplice - PB / Simple seal - PB

2 ANTE / 2 LEAVES

AUTOMAZIONE NEXT 150 NEXT 150 AUTOMATION		PANNELLO INOX STAINLESS STEEL PANEL	PANNELLO LAMINATO HPL PANEL
LASTRA DI PIOMBO LEAD PLATE	LARGHEZZA VANO FINO A (LV) OPENING WIDTH UP TO (LV)		
Pb 1 mm (1/16")	1000 mm (39 3/8")	HB-B150I2A-1000 1PB	HB-B150L2A-1000 1PB
Pb 1 mm (1/16")	1200 mm (47 1/4")	HB-B150I2A-1200 1PB	HB-B150L2A-1200 1PB
Pb 1 mm (1/16")	1400 mm (55 1/8")	HB-B150I2A-1400 1PB	HB-B150L2A-1400 1PB
Pb 1 mm (1/16")	1600 mm (63")	HB-B150I2A-1600 1PB	HB-B150L2A-1600 1PB
Pb 1 mm (1/16")	1800 mm (70 7/8")	HB-B150I2A-1800 1PB	HB-B150L2A-1800 1PB
Pb 1 mm (1/16")	2000 mm (78 3/4")	HB-B150I2A-2000 1PB	HB-B150L2A-2000 1PB
Pb 2 mm (1/8")	1000 mm (39 3/8")	HB-B150I2A-1000 2PB	HB-B150L2A-1000 2PB
Pb 2 mm (1/8")	1200 mm (47 1/4")	HB-B150I2A-1200 2PB	HB-B150L2A-1200 2PB
Pb 2 mm (1/8")	1400 mm (55 1/8")	HB-B150I2A-1400 2PB	HB-B150L2A-1400 2PB
Pb 2 mm (1/8")	1600 mm (63")	HB-B150I2A-1600 2PB	HB-B150L2A-1600 2PB
Pb 2 mm (1/8")	1800 mm (70 7/8")	HB-B150I2A-1800 2PB	HB-B150L2A-1800 2PB
Pb 2 mm (1/8")	2000 mm (78 3/4")	HB-B150I2A-2000 2PB	HB-B150L2A-2000 2PB

NOTA: Per ogni tipologia di porta è necessario specificare l'apertura se "A SPINGERE" o "A TIRARE" con riferimento vista lato automazione.

NOTE: For every type you must specify the type of opening, whether "PUSH" or "PULL", as seen from the operator side.

Larghezza max. anta motorizzata = 1200 mm - Larghezza min. anta manuale = 300 mm

"Master" leaf max. width = 1200 mm (47 1/4") - "slave" leaf min. width = 300 mm (11 3/16")

KIT	
Kit trasformazione a tenuta ermetica con elettromagnete <i>Hermetic seal conversion kit with maglock</i>	H-KBEA2

IMPORTANTE: La lastra di piombo è presente solo nel pannello e nel telaio. L'imbotte o l'estensione imbotte (se previste nella fornitura) non sono MAI dotate di lastra di piombo. Schermatura del muro/parete non di competenza LABEL.

IMPORTANT: The lead plate is present in the panel and the frame only. The wall frame or wall frame extension (if provided for in the supply) is NEVER equipped with a lead plate. Wall protection not in LABEL scope.



HB-B150I2A-PB
HB-B150L2A-PB

PORTE AUTOMATICHE A BATTENTE ASIMMETRICHE CON LASTRE IN PIOMBO
AUTOMATIC ASYMMETRICAL SWING DOORS WITH LEAD PLATES

■ HB-B150I2A PB

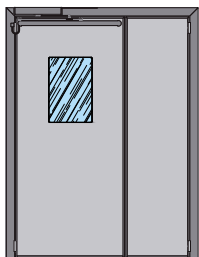

■ HB-B150L2A PB

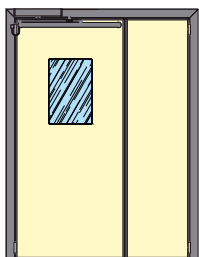

■ Acciaio / ST.Steel ■ Laminato / HPL

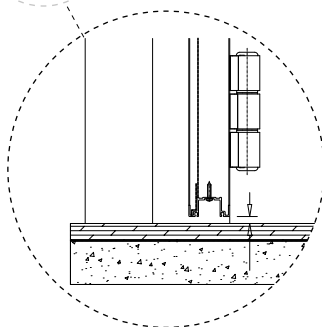
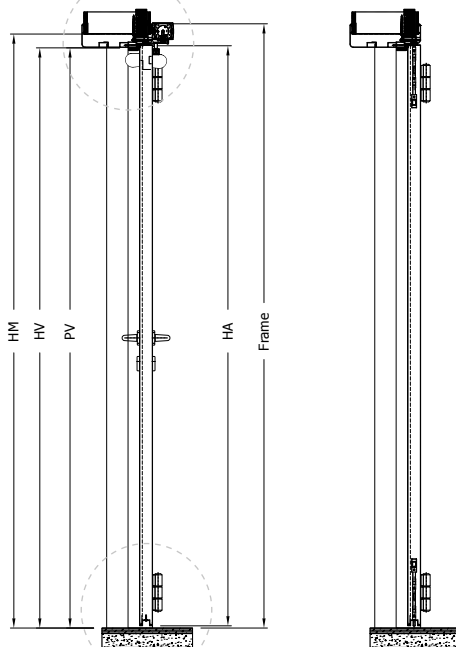
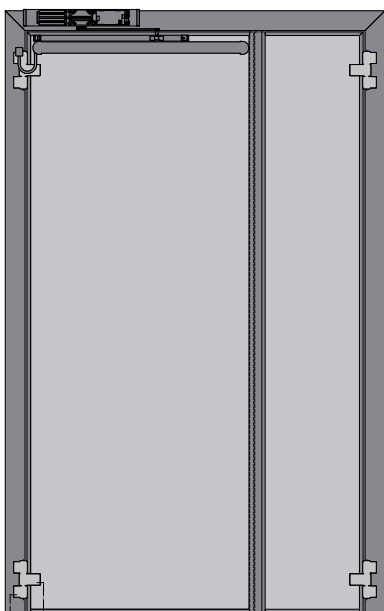
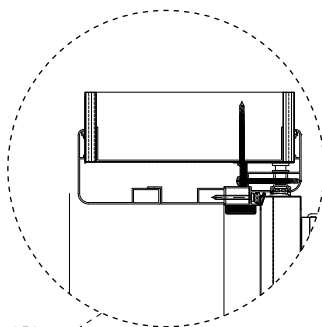
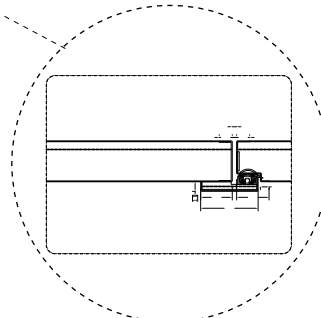
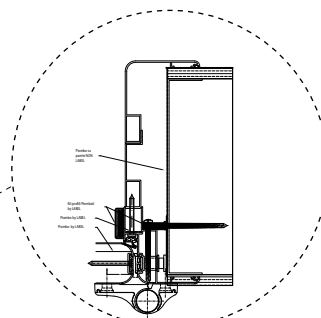
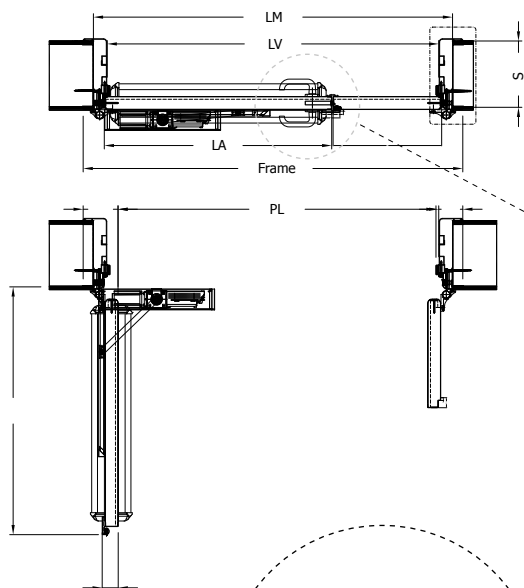

■ ■ **Legenda / Key**

PL	Passaggio netto orizzontale <i>Horizontal net passage</i>
PV	Passaggio netto verticale <i>Vertical net passage</i>
LT	Lunghezza automazione <i>Automation length</i>
LM	Larghezza vano grezzo <i>Unfinished opening width</i>
LV	Larghezza vano finito <i>Finished opening width</i>
LA	Larghezza anta <i>Leaf width</i>
HM	Altezza vano grezzo <i>Unfinished opening height</i>
HV	Altezza vano finito <i>Finished opening height</i>
HA	Altezza anta <i>Leaf height</i>
S	Spessore muro <i>Wall thickness</i>







PORTE AUTOMATICHE A BATTENTE A TENUTA SEMPLICE

Porte "TECNICHE" destinate a sale operatorie, laboratori, ambulatori e ambienti altamente asettici in genere per uso intensivo e delta pressione uguale o inferiore a 30 Pa.

La porta in versione automatica è fornita con telaio a muro porta cerniere, predisposto per il montaggio su mazzetta a muro o controtelaio e può essere completata con accessori quale visiva, maniglia, fascia paracolpi, dispositivi di impulso e sensori di sicurezza (radar, sensori a raggi infrarossi). La tenuta è garantita da guarnizioni in EPDM espanse montate sui profili in alluminio che coprono tre lati del perimetro dell'anta. Nella parte inferiore è installata, di serie, una spazzola in setole rigide e, su richiesta, un kit per tenuta ermetica.

Automazione mod. NB-SMP per porte a battente:

- Apertura e chiusura a motore per anta larghezza massima 1500 mm.
- Peso massimo per anta: kg 300.
- Dimensioni automazione (HxDxL) 110x120x730 mm.
- Adatta per ambienti in cui la pressione dell'aria filtrata introdotta dagli impianti di ventilazione è uguale o inferiore a 30 Pa.

Pannelli	Inclusi
	Automazione NB-SMP: <ul style="list-style-type: none"> • Copertura in alluminio colore argento anodizzato naturale - H.110 mm • Base supporto in alluminio L.730 mm • Fianchetti in ABS grigi - P. 120 mm • Sistema di trasmissione movimento cinghia antistatica rinforzata con cordoli in Kevlar • Alimentazione a 115/230Vac - 50/60Hz • Motore brushless con encoder incorporato ad elevate prestazioni, bassa usura e consumi ridotti
	Pannello anta completo di cornici e guarnizioni dedicate
	Anta completa di profili, vetro 44.2 e guarnizioni dedicate
	Gruppo copertura in alluminio
	Braccio a tirare H-BDT2FE o a spingere BSS2FE
	Programmatore digitale e sensori di sicurezza







AUTOMATIC SIMPLE SEALING SWING DOORS

"TECHNICAL" doors designed for operating rooms, laboratories, clinics, and highly aseptic environments in general, for intensive use and delta pressure not exceeding 30 Pa.

The automatic version of the door comes with a wall frame equipped for hinges, ready to be mounted on wall rabbets or on a subframe. It can be supplemented with the following accessories: vision panel, handle, bump band, pulse devices and safety sensors (radar, infrared sensors). Tightness is provided by expanded EPDM gaskets mounted on the aluminium profiles that cover three sides of the leaf perimeter. A rigid-bristle brush is installed on the bottom edge and an hermetic seal kit is available on request.

Automation model NB-SMP for swing doors:

- Motorized opening and closing, for maximum 1500 mm (59¹/₁₆") wide leaf.
- Maximum weight for each leaf: kg 300 (661lb).
- Automation dimensions (HxDxL) 110x120x730 mm (4³/₁₆" x 4³/₄" x 28³/₄").
- Suitable for environments where the filtered air pressure introduced by ventilation systems does not exceed 30Pa.

Panels	Includes
	Automation NB-SMP: <ul style="list-style-type: none"> • Aluminium cover in natural anodized-silver colour - H.110 mm (4³/₁₆"). • Aluminium support base width 730 mm (28³/₄") • Grey ABS side caps - Depth 120 mm (4³/₄") • Motion drive system using antistatic belt reinforced with Kevlar sides • 115/230Vac - 50/60Hz power supply • Brushless motor with built-in encoder, featuring high performance, low wear, low power consumption
	Leaf panel complete with dedicated frames and gaskets
	Leaf complete with profiles, 44.2 or 8 mm (5/16") glazing, and dedicated gaskets
	Aluminium covering unit
	Pull arm H-BDT2FE or push arm BSS2FE
	Digital selector and safety sensors



 Acciaio / ST.Steel  Laminato / HPL  Vetro / Glass

PORTE AUTOMATICHE A BATTENTE A TENUTA SEMPLICE AUTOMATIC SIMPLE SEALING SWING DOORS

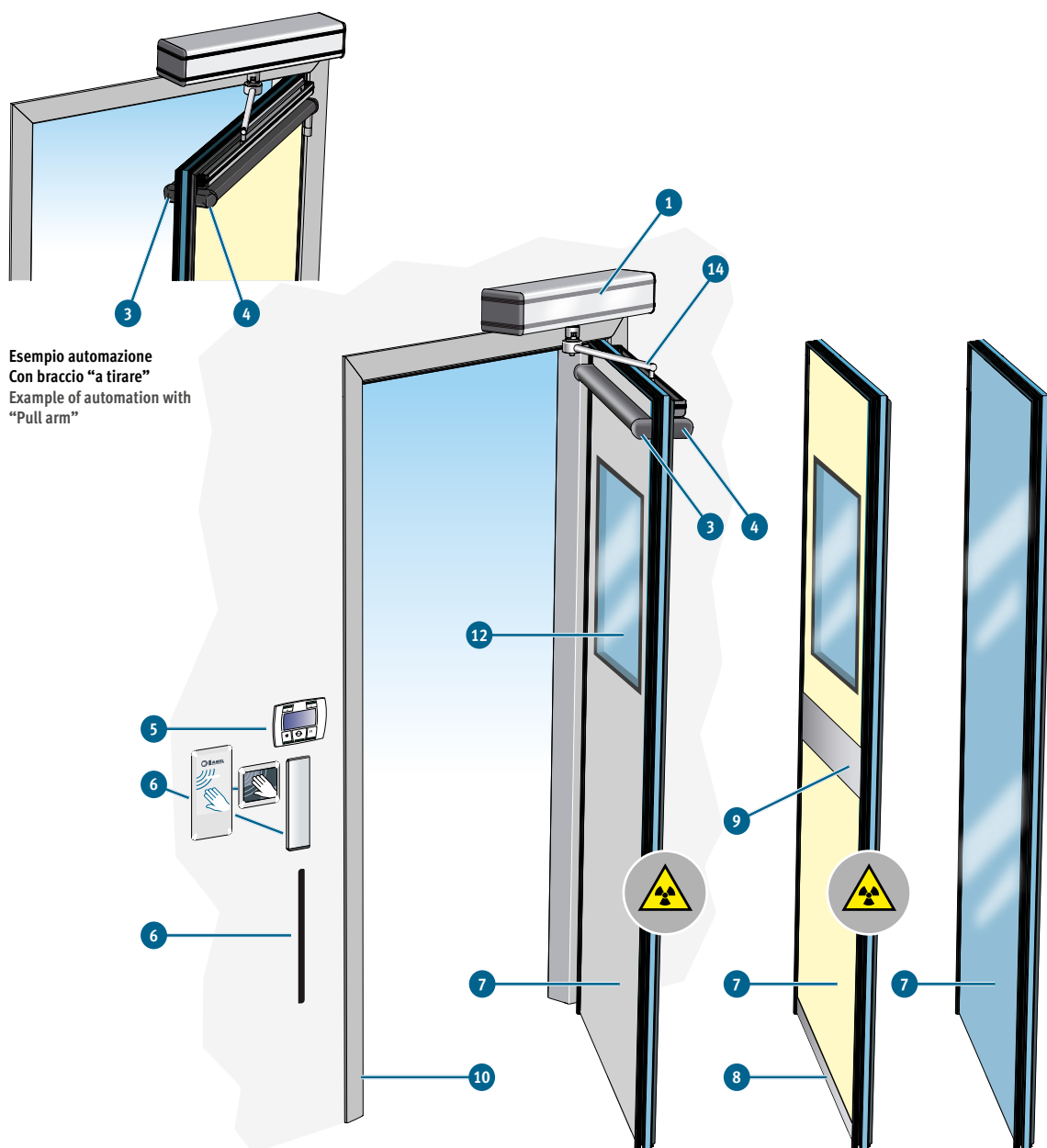

Esempio automazione
Con braccio "a tirare"
Example of automation with
"Pull arm"

Legenda / Key

- | | |
|---|---|
| 1 Gruppo automazione / Automation unit | 8 Zoccolo / Base |
| 3 Sensore di sicurezza lato chiusura / Closing-side safety sensor | 9 Fascia orizzontale / Horizontal band |
| 4 Sensore di sicurezza lato apertura / Opening-side safety sensor | 10 Telaio / Frame |
| 5 Programmatore digitale / Digital programmer | 12 Visiva (opzionale) / Vision panel (optional) |
| 6 Dispositivi di attivazione / Activation devices | 14 Braccio (a tirare o a spingere) / Arm (pull or push) |
| 7 Pannello / Panel | |



• Misurazione in laboratorio isolamento acustico n° 297957
(misurazione isolamento acustico sui pannelli effettuata con metodo empirico).

• Laboratory measurement of sound insulation no. 297957
(measurement of panel sound insulation performed using the empirical method).



Porta automatica a battente a tenuta semplice - 1 anta
Automatic simple sealing swing door - 1 leaf

Tenuta semplice / Simple seal

1 ANTA / 1 LEAF

AUTOMAZIONE NB300SMP NB300SMP AUTOMATION	HB-B300I1	HB-B300L1	HB-B300V1
	PANNELLO INOX STAINLESS STEEL PANEL	PANNELLO LAMINATO HPL PANEL	PANNELLO VETRO GLASS PANEL
LARGHEZZA VANO FINO A (LV) OPENING WIDTH UP TO (LV)			
800 mm (31½")	HB-B300I1-800	HB-B300L1-800	HB-B300V1-800
900 mm (35¼")	HB-B300I1-900	HB-B300L1-900	HB-B300V1-900
1000 mm (39¾")	HB-B300I1-1000	HB-B300L1-1000	HB-B300V1-1000
1100 mm (43⅝")	HB-B300I1-1100	HB-B300L1-1100	HB-B300V1-1100
1200 mm (47¼")	HB-B300I1-1200	HB-B300L1-1200	HB-B300V1-1200

NOTA: Per ogni tipologia di porta è necessario specificare l'apertura se "A SPINGERE" o "A TIRARE" con riferimento vista lato automazione.

NOTE: For every type you must specify the type of opening, whether "PUSH" or "PULL", as seen from the operator side.

	HB-B300I1 - HB-B300L1	
	Kit trasformazione a tenuta ermetica con elettromagnete Hermetic seal conversion kit with maglock	H-KBEA1
	Elettromagnete Maglock	
	Guarnizione mobile a pavimento Drop seal	
		Guarnizione perimetrale Perimeter seal

Elementi Opzionali da ordinare separatamente al momento dell'ordine
Optional items to be ordered separately at time of order

Colorazioni e finiture speciali Special colours and finishes	Fasce / Bands	Rivestimenti gruppo copertura Covering unit cladding	Visiva / Vision panel	Tendine elettriche e manuali Manual and electric blinds	Piombature Lead foils
pag./page 120	pag./page 103	pag./page 102	pag./page 96	pag./page 96	pag./page 104
Maniglie e maniglioni per porte scorrevoli Handle for Sliding Door	Maniglie per porte manuali a battente Level handle for manual swing door	Serrature Mechanical Lock	Dispositivi di impulso (se diversi da quelli standard) Pulse devices (if other than the standard ones)	Batterie di apertura in emergenza Emergency opening batteries	Imbotti e semi-imbotti Wall frame and semi-wall frame
pag./page 108	pag./page 109	pag./page 110	pag./page 117	pag./page 118	pag./page 100

■ Acciaio / ST. Steel ■ Laminato / HPL ■ Vetro / Glass

■ HB-B300I1 ■ HB-B300L1

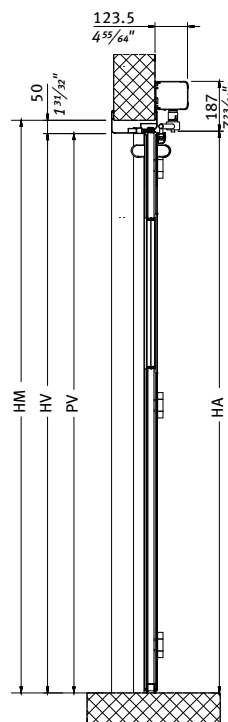
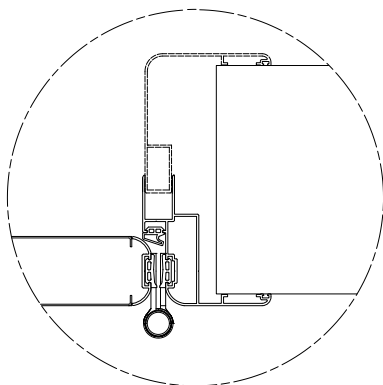
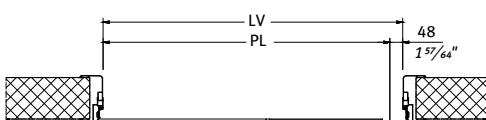
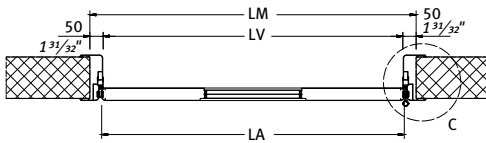
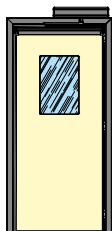
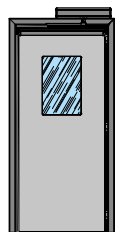

■ HB-B300V1

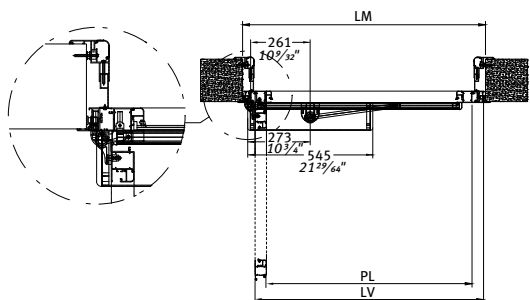
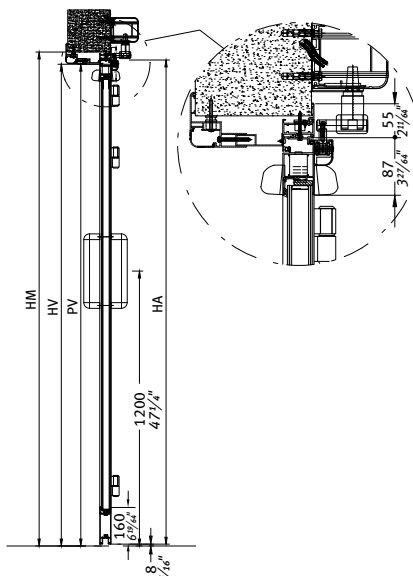
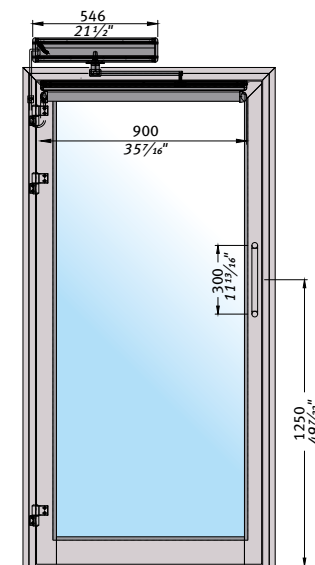

■ ■ ■ **Legenda / Key**

PL	Passaggio netto orizzontale Horizontal net passage
PV	Passaggio netto verticale Vertical net passage
LT	Lunghezza automazione Automation length
LM	Larghezza vano grezzo Unfinished opening width
LV	Larghezza vano finito Finished opening width
LA	Larghezza anta Leaf width
HM	Altezza vano grezzo Unfinished opening height
HV	Altezza vano finito Finished opening height
HA	Altezza anta Leaf height



Porta automatica a battente a tenuta semplice - 2 ante
Automatic simple sealing swing door - 2 leaves

Tenuta semplice / Simple seal

2 ANTE / 2 LEAVES

AUTOMAZIONE NB300SMP NB300SMP AUTOMATION	HB-B300I2	HB-B300L2	HB-B300V2
	PANNELLO INOX STAINLESS STEEL PANEL	PANNELLO LAMINATO HPL PANEL	PANNELLO VETRO GLASS PANEL
LARGHEZZA VANO FINO A (LV) OPENING WIDTH UP TO (LV)			
1000 mm (39 ³ / ₈ "	HB-B300I2-1000	HB-B300L2-1000	HB-B300V2-1000
1200 mm (47 ¹ / ₄ "	HB-B300I2-1200	HB-B300L2-1200	HB-B300V2-1200
1400 mm (55 ¹ / ₈ "	HB-B300I2-1400	HB-B300L2-1400	HB-B300V2-1400
1600 mm (63"	HB-B300I2-1600	HB-B300L2-1600	HB-B300V2-1600
1800 mm (70 ⁷ / ₈ "	HB-B300I2-1800	HB-B300L2-1800	HB-B300V2-1800
2000 mm (78 ³ / ₄ "	HB-B300I2-2000	HB-B300L2-2000	HB-B300V2-2000

NOTA: Per ogni tipologia di porta è necessario specificare l'apertura se "A SPINGERE" o "A TIRARE" con riferimento vista lato automazione.
NOTE: For every type you must specify the type of opening, whether "PUSH" or "PULL", as seen from the operator side.

	HB-B300I2 - HB-B300L2	
	Kit trasformazione a tenuta ermetica con elettromagnete <i>Hermetic seal conversion kit with maglock</i>	H-KBEA2
	Elettromagnete <i>Maglock</i>	
	Guarnizione mobile a pavimento <i>Drop seal</i>	
		Guarnizione perimetrale <i>Perimeter seal</i>

Elementi Opzionali da ordinare separatamente al momento dell'ordine
Optional items to be ordered separately at time of order

Colorazioni e finiture speciali <i>Special colours and finishes</i>	Fasce / Bands	Rivestimenti gruppo copertura <i>Covering unit cladding</i>	Visiva / Vision panel	Tendine elettriche e manuali <i>Manual and electric blinds</i>	Piombature <i>Lead foils</i>
pag./page 120	pag./page 103	pag./page 102	pag./page 96	pag./page 96	pag./page 104
Maniglie e maniglioni per porte scorrevoli <i>Handle for Sliding Door</i>	Maniglie per porte manuali a battente <i>Level handle for manual swing door</i>	Serrature <i>Mechanical Lock</i>	Dispositivi di impulso (se diversi da quelli standard) <i>Pulse devices (if other than the standard ones)</i>	Batterie di apertura in emergenza <i>Emergency opening batteries</i>	Imbotti e semi-imbotti <i>Wall frame and semi-wall frame</i>
pag./page 108	pag./page 109	pag./page 110	pag./page 117	pag./page 118	pag./page 100

■ HB-B300I2

■ HB-B300L2

■ Acciaio / ST. Steel

■ Laminato / HPL

■ Vetro / Glass

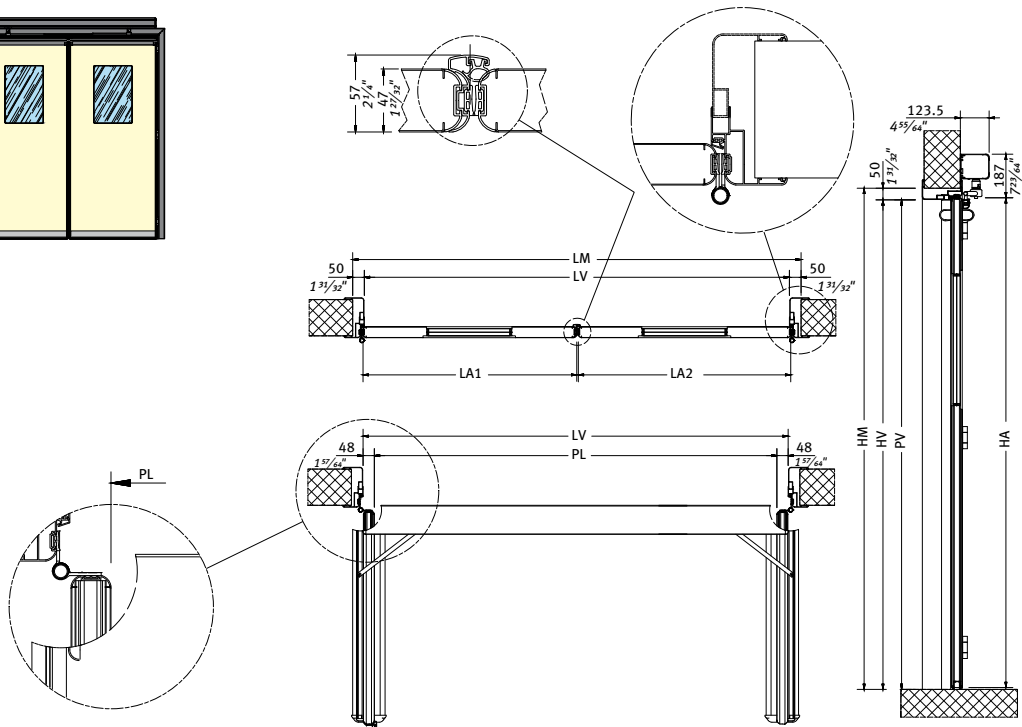
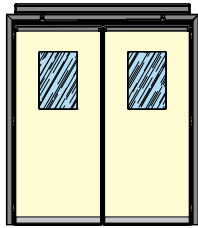
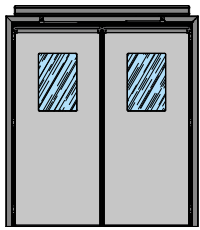

■ HB-B300V2

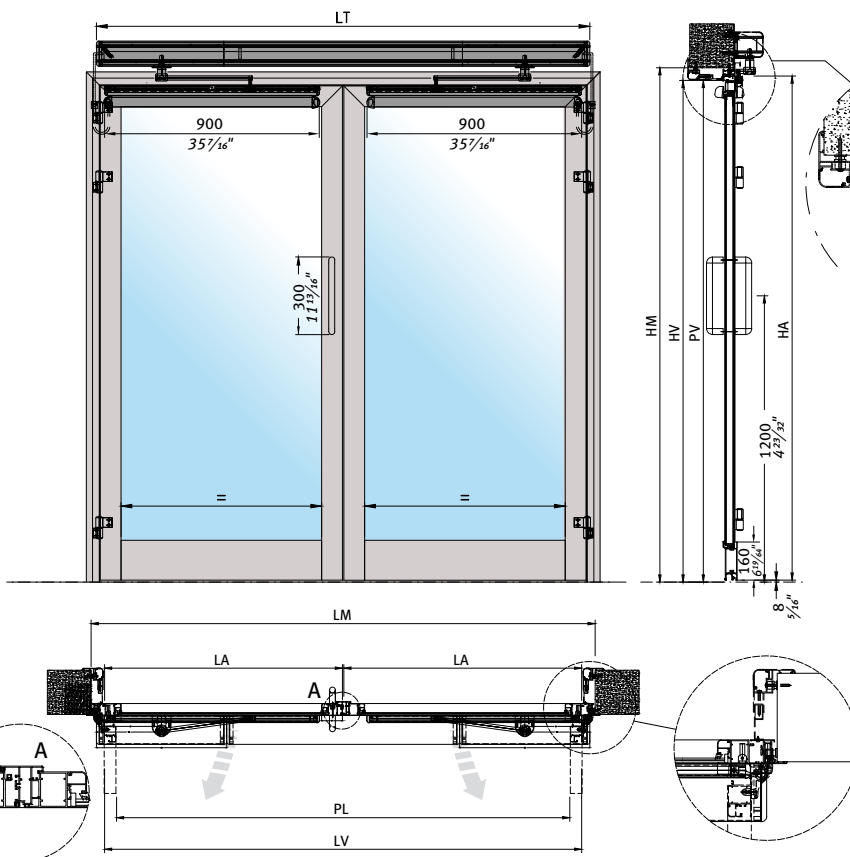

■ ■ ■ **Legenda / Key**

PL	Passaggio netto orizzontale <i>Horizontal net passage</i>
PV	Passaggio netto verticale <i>Vertical net passage</i>
LT	Lunghezza automazione <i>Automation length</i>
LM	Larghezza vano grezzo <i>Unfinished opening width</i>
LV	Larghezza vano finito <i>Finished opening width</i>
LA	Larghezza anta <i>Leaf width</i>
HM	Altezza vano grezzo <i>Unfinished opening height</i>
HV	Altezza vano finito <i>Finished opening height</i>
HA	Altezza anta <i>Leaf height</i>



Porta automatica a battente asimmetrica a tenuta semplice - 2 ante
Simple sealing asymmetric automatic swing door - 2 leaves

Tenuta semplice / Simple seal

2 ANTE / 2 LEAVES

AUTOMAZIONE NB300SMP NB300SMP AUTOMATION	HB-B300I2A	HB-B300L2A	HB-B300V2A
	PANNELLO INOX STAINLESS STEEL PANEL	PANNELLO LAMINATO HPL PANEL	PANNELLO VETRO GLASS PANEL
LARGHEZZA VANO FINO A (LV) OPENING WIDTH UP TO (LV)			
1000 mm (39 ³ / ₈ "	-	-	HB-B300V2A-1000
1200 mm (47 ¹ / ₄ "	HB-B300I2A-1200	HB-B300L2A-1200	HB-B300V2A-1200
1400 mm (55 ¹ / ₈ "	HB-B300I2A-1400	HB-B300L2A-1400	HB-B300V2A-1400
1600 mm (63"	HB-B300I2A-1600	HB-B300L2A-1600	HB-B300V2A-1600
1800 mm (70 ⁷ / ₈ "	HB-B300I2A-1800	HB-B300L2A-1800	HB-B300V2A-1800
2000 mm (78 ³ / ₄ "	HB-B300I2A-2000	HB-B300L2A-2000	HB-B300V2A-2000

Larghezza max. anta motorizzata = 1200 mm - Larghezza min. anta manuale "slave" = 300 mm
 "Master" leaf max. width = 1200 mm (47¹/₄" - manual "slave" leaf min. width = 300 mm (11³/₈")

Anta manuale "slave" min. 500 mm
 "Slave" manual leaf min. 500 mm

NOTA: Per ogni tipologia di porta è necessario specificare l'apertura se "A SPINGERE" o "A TIRARE" con riferimento vista lato automazione
 NOTE: For every type you must specify the type of opening, whether "PUSH" or "PULL", as seen from the operator side

 HB-B300I2A HB-B300L2A	Applicabile per larghezza anta da 340 a 1230 mm / <i>Applicable for 340 to 1230 mm leaf width (13³/₈" to 48⁷/₁₆"</i>	
Kit trasformazione a tenuta ermetica <i>Hermetic seal conversion kit</i>		H-KBEM1
Kit trasformazione a tenuta ermetica con elettromagnete <i>Hermetic seal conversion kit with maglock</i>		H-KBEA1
Elettromagnete <i>Maglock</i>	Guarnizione mobile a pavimento <i>Drop seal</i>	Guarnizione perimetrale <i>Perimeter seal</i>

Elementi Opzionali da ordinare separatamente al momento dell'ordine
Optional items to be ordered separately at time of order

Colorazioni e finiture speciali <i>Special colours and finishes</i>	Fasce / Bands	Rivestimenti gruppo copertura <i>Covering unit cladding</i>	Visiva / Vision panel	Tendine elettriche e manuali <i>Manual and electric blinds</i>	Piombature <i>Lead foils</i>
pag./page 120	pag./page 103	pag./page 102	pag./page 96	pag./page 96	pag./page 104
Maniglie e maniglioni per porte scorrevoli <i>Handle for Sliding Door</i>	Maniglie per porte manuali a battente <i>Level handle for manual swing door</i>	Serrature <i>Mechanical Lock</i>	Dispositivi di impulso (se diversi da quelli standard) <i>Pulse devices (if other than the standard ones)</i>	Batterie di apertura in emergenza <i>Emergency opening batteries</i>	Imbotti e semi-imbotti <i>Wall frame and semi-wall frame</i>
pag./page 108	pag./page 109	pag./page 110	pag./page 117	pag./page 118	pag./page 100

■ Acciaio / ST. Steel ■ Laminato / HPL ■ Vetro / Glass

■ HB-B300I2A

■ HB-B300L2A

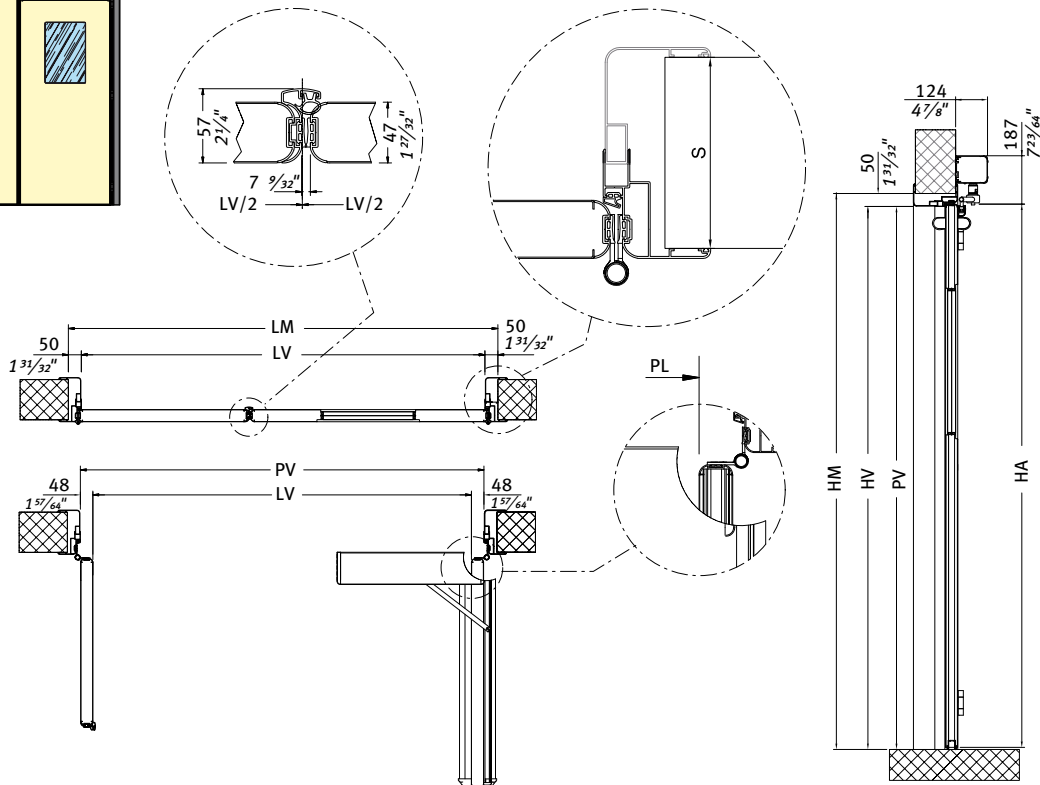
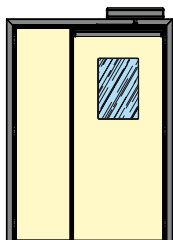
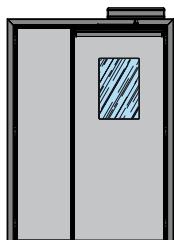

■ HB-B300V2A

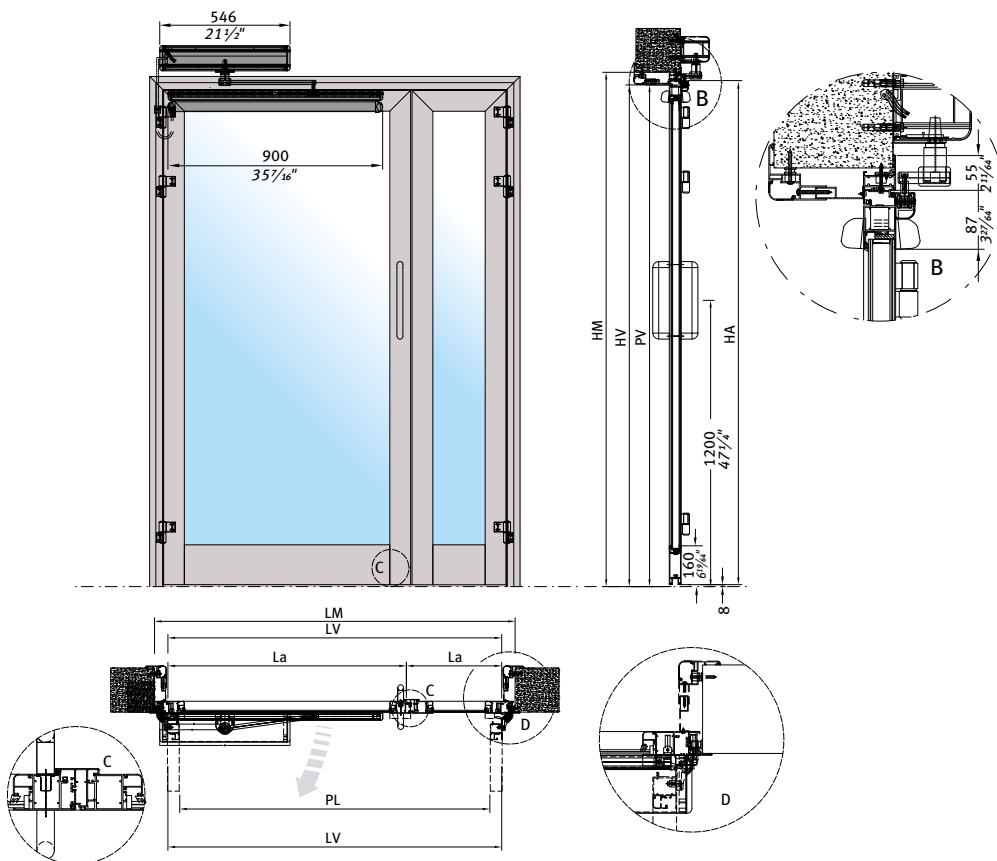

■ ■ ■ **Legenda / Key**

PL	Passaggio netto orizzontale Horizontal net passage
PV	Passaggio netto verticale Vertical net passage
LT	Lunghezza automazione Automation length
LM	Larghezza vano grezzo Unfinished opening width
LV	Larghezza vano finito Finished opening width
LA	Larghezza anta Leaf width
HM	Altezza vano grezzo Unfinished opening height
HV	Altezza vano finito Finished opening height
HA	Altezza anta Leaf height
S	Spessore muro Wall thickness



Porta automatica a battente con lastre in piombo - 1 anta
Automatic swing door with lead plates - 1 leaf

AUTOMAZIONE NB300SMP NB300SMP AUTOMATION		PANNELLO INOX STAINLESS STEEL PANEL	PANNELLO LAMINATO HPL PANEL
LASTRA DI PIOMBO LEAD PLATE	LARGHEZZA VANO FINO A (LV) OPENING WIDTH UP TO (LV)		
Pb 1 mm (1/16")	800 mm (31 1/2")	HB-B300I1-800 1PB	HB-B300L1-800 1PB
Pb 1 mm (1/16")	900 mm (35 7/16")	HB-B300I1-900 1PB	HB-B300L1-900 1PB
Pb 1 mm (1/16")	1000 mm (39 3/8")	HB-B300I1-1000 1PB	HB-B300L1-1000 1PB
Pb 1 mm (1/16")	1100 mm (43 3/16")	HB-B300I1-1100 1PB	HB-B300L1-1100 1PB
Pb 1 mm (1/16")	1200 mm (47 1/4")	HB-B300I1-1200 1PB	HB-B300L1-1200 1PB
Pb 2 mm (1/8")	800 mm (31 1/2")	HB-B300I1-800 2PB	HB-B300L1-800 2PB
Pb 2 mm (1/8")	900 mm (35 7/16")	HB-B300I1-900 2PB	HB-B300L1-900 2PB
Pb 2 mm (1/8")	1000 mm (39 3/8")	HB-B300I1-1000 2PB	HB-B300L1-1000 2PB
Pb 2 mm (1/8")	1100 mm (43 3/16")	HB-B300I1-1100 2PB	HB-B300L1-1100 2PB
Pb 2 mm (1/8")	1200 mm (47 1/4")	HB-B300I1-1200 2PB	HB-B300L1-1200 2PB
Pb 3 mm (3/16")	800 mm (31 1/2")	HB-B300I1-800 3PB	HB-B300L1-800 3PB
Pb 3 mm (3/16")	900 mm (35 7/16")	HB-B300I1-900 3PB	HB-B300L1-900 3PB
Pb 3 mm (3/16")	1000 mm (39 3/8")	HB-B300I1-1000 3PB	HB-B300L1-1000 3PB
Pb 3 mm (3/16")	1100 mm (43 3/16")	HB-B300I1-1100 3PB	HB-B300L1-1100 3PB
Pb 3 mm (3/16")	1200 mm (47 1/4")	HB-B300I1-1200 3PB	HB-B300L1-1200 3PB

NOTA: Per ogni tipologia di porta è necessario specificare l'apertura se "A SPINGERE" o "A TIRARE" con riferimento vista lato automazione. Prezzi validi per porte a battenti con altezza vano (HV) = fino a 2150 mm.

NOTE: For every type you must specify the type of opening, whether "PUSH" or "PULL", as seen from the operator side. Prices valid for swing doors with opening heights (HV) up to 2150 mm - 84%.

KIT	
Kit trasformazione a tenuta ermetica con elettromagnete Hermetic seal conversion kit with maglock	H-KBEA1

IMPORTANTE: La lastra di piombo è presente solo nel pannello e nel telaio. L'imbotte o l'estensione imbotte (se previste nella fornitura) non sono MAI dotate di lastra di piombo. Schermatura del muro/parete non di competenza LABEL.

IMPORTANT: The lead plate is present in the panel and the frame only. The wall frame or wall frame extension (if provided for in the supply) is NEVER equipped with a lead plate. Wall protection not in LABEL scope.



HB-B300I2-PB
HB-B300L2-PB

PORTE AUTOMATICHE A BATTENTE CON LASTRE IN PIOMBO
AUTOMATIC SWING DOORS WITH LEAD PLATES



Porta automatica a battente con lastre in piombo - 2 ante
Automatic swing door with lead plates - 2 leaves

AUTOMAZIONE NB300SMP NB300SMP AUTOMATION		PANNELLO INOX STAINLESS STEEL PANEL	PANNELLO LAMINATO HPL PANEL
LASTRA DI PIOMBO LEAD PLATE	LARGHEZZA VANO FINO A (LV) OPENING WIDTH UP TO (LV)		
Pb 1 mm (1/16")	1000 mm (39 3/8")	HB-B300I2-1000 1PB	HB-B300L2-1000 1PB
Pb 1 mm (1/16")	1200 mm (47 1/4")	HB-B300I2-1200 1PB	HB-B300L2-1200 1PB
Pb 1 mm (1/16")	1400 mm (55 1/8")	HB-B300I2-1400 1PB	HB-B300L2-1400 1PB
Pb 1 mm (1/16")	1600 mm (63")	HB-B300I2-1600 1PB	HB-B300L2-1600 1PB
Pb 1 mm (1/16")	1800 mm (70 7/8")	HB-B300I2-1800 1PB	HB-B300L2-1800 1PB
Pb 1 mm (1/16")	2000 mm (78 3/4")	HB-B300I2-2000 1PB	HB-B300L2-2000 1PB
Pb 2 mm (1/8")	1000 mm (39 3/8")	HB-B300I2-1000 2PB	HB-B300L2-1000 2PB
Pb 2 mm (1/8")	1200 mm (47 1/4")	HB-B300I2-1200 2PB	HB-B300L2-1200 2PB
Pb 2 mm (1/8")	1400 mm (55 1/8")	HB-B300I2-1400 2PB	HB-B300L2-1400 2PB
Pb 2 mm (1/8")	1600 mm (63")	HB-B300I2-1600 2PB	HB-B300L2-1600 2PB
Pb 2 mm (1/8")	1800 mm (70 7/8")	HB-B300I2-1800 2PB	HB-B300L2-1800 2PB
Pb 2 mm (1/8")	2000 mm (78 3/4")	HB-B300I2-2000 2PB	HB-B300L2-2000 2PB
Pb 3 mm (3/8")	1000 mm (39 3/8")	HB-B300I2-1000 3PB	HB-B300L2-1000 3PB
Pb 3 mm (3/8")	1200 mm (47 1/4")	HB-B300I2-1200 3PB	HB-B300L2-1200 3PB
Pb 3 mm (3/8")	1400 mm (55 1/8")	HB-B300I2-1400 3PB	HB-B300L2-1400 3PB
Pb 3 mm (3/8")	1600 mm (63")	HB-B300I2-1600 3PB	HB-B300L2-1600 3PB
Pb 3 mm (3/8")	1800 mm (70 7/8")	HB-B300I2-1800 3PB	HB-B300L2-1800 3PB
Pb 3 mm (3/8")	2000 mm (78 3/4")	HB-B300I2-2000 3PB	HB-B300L2-2000 3PB

NOTA: Per ogni tipologia di porta è necessario specificare l'apertura se "A SPINGERE" o "A TIRARE" con riferimento vista lato automazione. Prezzi validi per porte a battenti con altezza vano (HV) = fino a 2150 mm.

NOTE: For every type you must specify the type of opening, whether "PUSH" or "PULL", as seen from the operator side. Prices valid for swing doors with opening heights (HV) up to 2150 mm - 84 3/8".

KIT (Applicabile per larghezza anta da 340 a 1230 mm / Applicable for 340 to 1230 mm leaf width (13 3/8" to 48 7/16"))	
Kit trasformazione a tenuta ermetica con elettromagnete Hermetic seal conversion kit with maglock	H-KBEA2

IMPORTANTE: La lastra di piombo è presente solo nel pannello e nel telaio. L'imbotte o l'estensione imbotte (se previste nella fornitura) non sono MAI dotate di lastra di piombo. Schermatura del muro/parete non di competenza LABEL.



IMPORTANT: The lead plate is present in the panel and the frame only. The wall frame or wall frame extension (if provided for in the supply) is NEVER equipped with a lead plate. Wall protection not in LABEL scope.

PORTE MANUALI A BATTENTE A TENUTA SEMPLICE

Porte "TECNICHE" destinate a sale operatorie, laboratori, ambulatori e ambienti altamente asettici in genere.

La porta in versione manuale è fornita con telaio a muro porta cerniere, predisposto per il montaggio su mazzetta a muro o controtelaio e può essere completata con accessori quale visiva, maniglia, fascia paracolpi.

La tenuta è garantita da guarnizioni in EPDM espanse montate sui profili in alluminio che coprono tre lati del perimetro dell'anta. Nella parte inferiore è installata, di serie, una spazzola in setole rigide e, su richiesta, un kit per tenuta ermetica.



Pannelli	Inclusi
	Pannello anta completo di cornici e guarnizioni dedicate, le maniglie e serrature non saranno incluse nella fornitura base questo vale su tutte le tipologie, serratura e cilindro europeo
	Anta completa di profili, vetro 44.2, guarnizioni dedicate e cerniere, le maniglie e serrature non saranno incluse nella fornitura base questo vale su tutte le tipologie, serratura e cilindro europeo

Le porte manuali possono essere automatizzate scegliendo il kit di trasformazione adatto al senso di apertura dell'anta. Per i dettagli tecnici del prodotto consultare la documentazione tecnica dell'automazione NEXT 75.



MANUAL SIMPLE SEALING SWING DOORS

"TECHNICAL" doors intended for operating theatres, laboratories, clinics and highly aseptic environments in general.

The manual version of the door comes with a wall frame equipped for hinges, ready to be mounted on rabbets in the wall or on a sub-frame. It can be supplemented with the following accessories: vision panel, handle, bump band. The seal is ensured by expanded EPDM gaskets mounted on the aluminium profiles that cover three sides of the leaf perimeter. A rigid-bristle brush is installed on the bottom edge and a hermetic seal kit is available on request.

Panels	Includes
	Leaf panel complete with frames and dedicated gaskets. Handles and locks will not be included in the basic supply, this applies to all types, European lock and cylinder
	Leaf complete with profiles, 44.2 or 8 mm (5/16") glazing, dedicated gaskets and hinges. Handles and locks will not be included in the basic supply, this applies to all types, European lock and cylinder

Manual doors can be automated by choosing the conversion kit suitable for the direction opening of the leaf. For technical details of the product, refer to the Next 75 automation technical documentation.

	H-KNEXT-BDT	<p>Kit trasformazione per porta a battente A TIRARE servoassistita composto da:</p> <ul style="list-style-type: none"> - Automazione battente A TIRARE per interni con batteria - Braccio dritto a TIRARE - Perno per estensione albero - Pulsante a gomito colore argento (OT-3S) <p>Transformation kit for servo-assisted PULL swing door composed by:</p> <ul style="list-style-type: none"> - Automation for interior PULL swing door with battery - PULL sliding arm - Arm extension shaft - Elbow button silver colour (OT-3S)
	H-KNEXT-BDS	<p>Kit trasformazione per porta a battente A SPINGERE servoassistita composto da:</p> <ul style="list-style-type: none"> - Automazione battente A SPINGERE per interni con batteria - Braccio dritto a SPINGERE - Perno per estensione albero - Pulsante a gomito colore argento (OT-3S) <p>Transformation kit for servo-assisted PUSH swing door composed by:</p> <ul style="list-style-type: none"> - Automation for interior PUSH swing door with battery - PUSH sliding arm - Arm extension shaft - Elbow button silver colour (OT-3S)
	H-KNEXT-BAS	<p>Kit trasformazione per porta a battente A SPINGERE servoassistita composta da:</p> <ul style="list-style-type: none"> - Automazione battente A SPINGERE per interni con batteria - Braccio articolato A SPINGERE - Perno per estensione albero - Pulsante a gomito colore argento (OT-3S) <p>Transformation kit for servo-assisted PUSH swing door composed by:</p> <ul style="list-style-type: none"> - Automation for interior PUSH swing door with battery - PUSH articulated arm - Arm extension shaft - Elbow button silver colour (OT-3S)

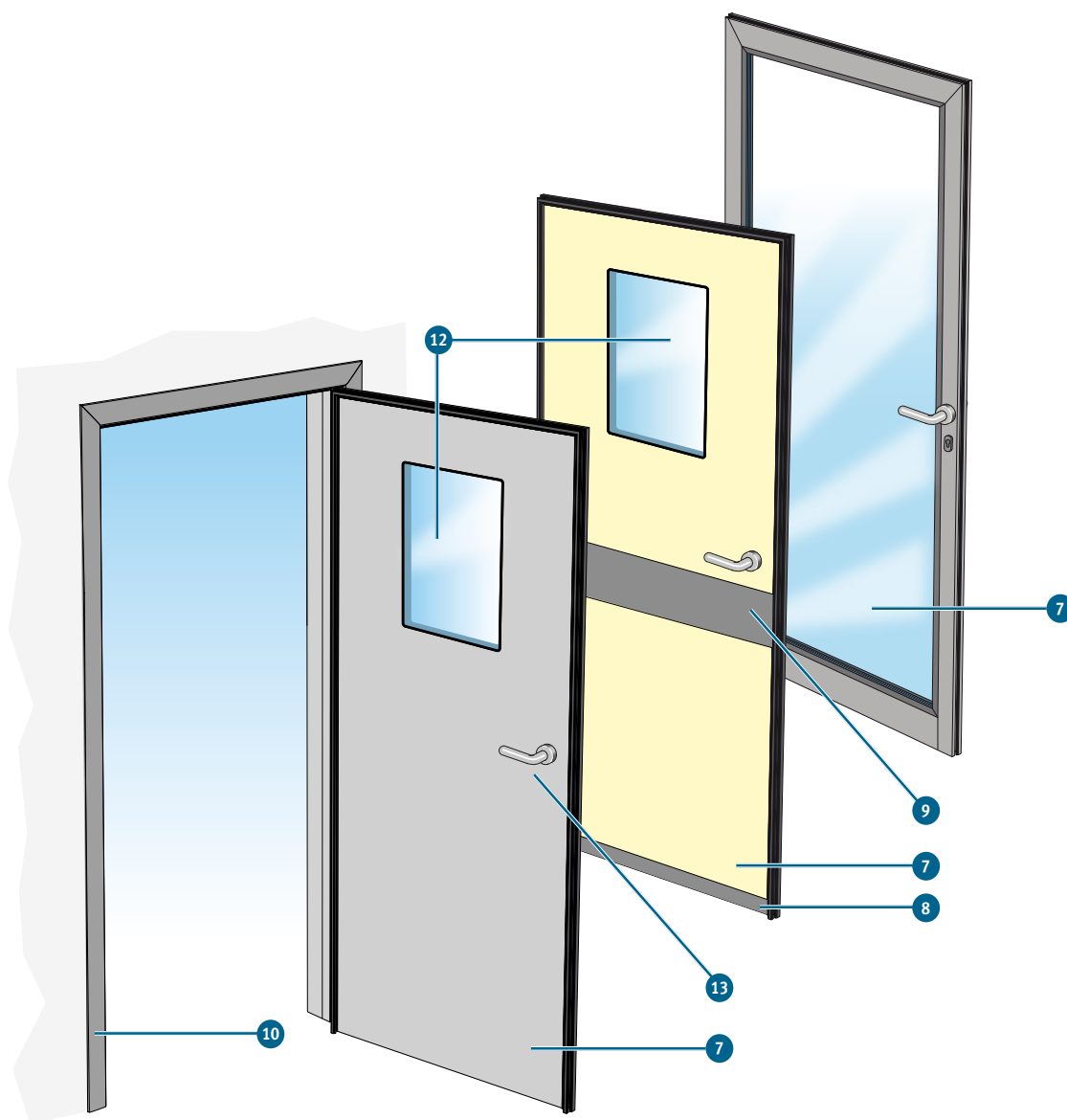

Legenda / Key

7 Pannello / Panel

8 Zoccolo / Base

9 Fascia orizzontale / Horizontal band

10 Imbotte (o semi-imbotte) opzionale
 Optional wall frame (or semi-wall frame)

12 Visiva (opzionale) / Vision panel (optional)

13 Maniglia a leva da scegliere a pag. 108
 Lever handle to be chosen on page 108

■ Acciaio / ST.Steel ■ Laminato / HPL ■ Vetro / Glass



Porta manuale a battente a tenuta semplice - 1 anta
Manual simple sealing swing door - 1 leaf

	H-BMI1	H-BML1	H-BMV1
	PANNELLO INOX STAINLESS STEEL PANEL	PANNELLO LAMINATO HPL PANEL	PANNELLO VETRO GLASS PANEL
LARGHEZZA VANO FINO A (LV) OPENING WIDTH UP TO (LV)			
800 mm (31½")	H-BMI1-800	H-BML1-800	H-BMV1-800
900 mm (35¼")	H-BMI1-900	H-BML1-900	H-BMV1-900
1000 mm (39¾")	H-BMI1-1000	H-BML1-1000	H-BMV1-1000
1100 mm (43⅝")	H-BMI1-1100	H-BML1-1100	H-BMV1-1100
1200 mm (47¼")	H-BMI1-1200	H-BML1-1200	H-BMV1-1200
KIT			
Kit trasf. servoassistita con batteria con braccio BDT (a tirare) Servo-assisted transformation kit with battery with BDT pull arm			H-KNEXT-BDT
Kit trasf. servoassistita con batteria con braccio BDS (a spingere) Servo-assisted transformation kit with battery with BDS push arm			H-KNEXT-BDS
Kit trasf. servoassistita con batteria con braccio BAS (articolato a spingere) Servo-assisted transformation kit with battery with articulated push arm (BAS)			H-KNEXT-BAS
Kit trasformazione a tenuta ermetica - <input type="checkbox"/> H-BMI1 - <input type="checkbox"/> H-BML1 <i>Hermetic seal conversion kit - <input type="checkbox"/> H-BMI1 - <input type="checkbox"/> H-BML1</i>			H-KBEM1

Elementi Opzionali da ordinare separatamente al momento dell'ordine
Optional items to be ordered separately at time of order

Colorazioni e finiture speciali Special colours and finishes	Fasce / Bands	Rivestimenti gruppo copertura Covering unit cladding	Visiva / Vision panel	Tendine elettriche e manuali Manual and electric blinds	Piombature Lead foils
pag./page 120	pag./page 103	pag./page 102	pag./page 96	pag./page 96	pag./page 104
Maniglie e maniglioni per porte scorrevoli Handle for Sliding Door	Maniglie per porte manuali a battente Level handle for manual swing door	Serrature Mechanical Lock	Dispositivi di impulso (se diversi da quelli standard) Pulse devices (if other than the standard ones)	Batterie di apertura in emergenza Emergency opening batteries	Imbotti e semi-imbotti Wall frame and semi-wall frame
pag./page 108	pag./page 109	pag./page 110	pag./page 117	pag./page 118	pag./page 100

■ Acciaio / ST. Steel ■ Laminato / HPL ■ Vetro / Glass

■ H-BM1

■ H-BML1

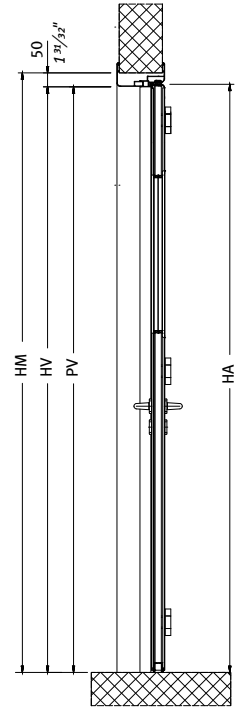
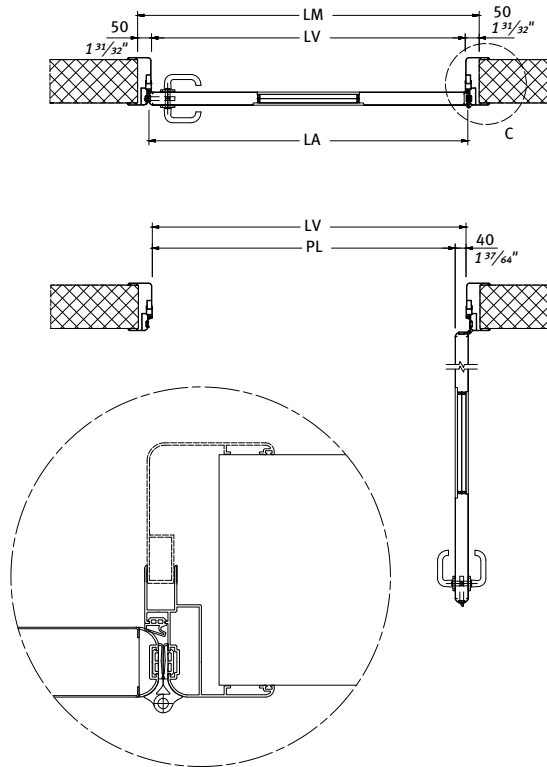
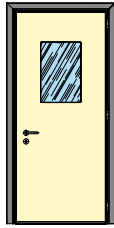
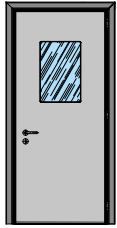

■ H-BMV1

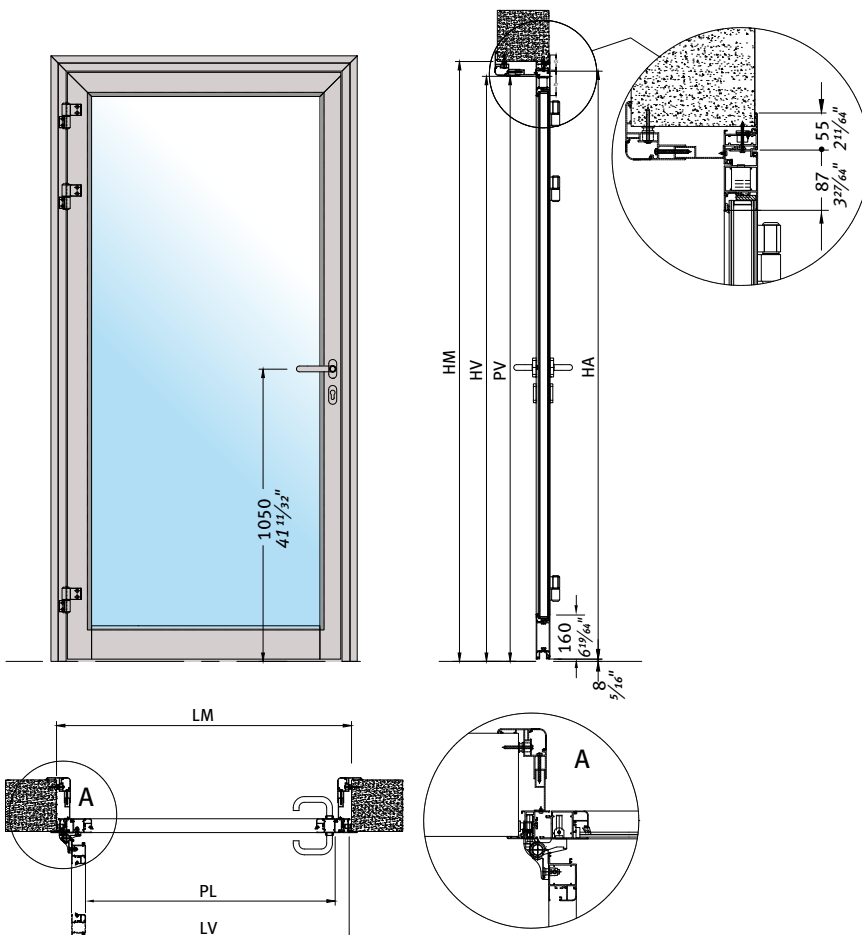

■ ■ ■ **Legenda / Key**

PL	Passaggio netto orizzontale <i>Horizontal net passage</i>
PV	Passaggio netto verticale <i>Vertical net passage</i>
LM	Larghezza vano grezzo <i>Unfinished opening width</i>
LV	Larghezza vano finito <i>Finished opening width</i>
LA	Larghezza anta <i>Leaf width</i>
HM	Altezza vano grezzo <i>Unfinished opening height</i>
HV	Altezza vano finito <i>Finished opening height</i>
HA	Altezza anta <i>Leaf height</i>



Porta manuale a battente a tenuta semplice - 2 ante
Manual simple sealing swing door - 2 leaves

	H-BMI2	H-BML2	H-BMV2
	PANNELLO INOX STAINLESS STEEL PANEL	PANNELLO LAMINATO HPL PANEL	PANNELLO VETRO GLASS PANEL
LARGHEZZA VANO FINO A (LV) OPENING WIDTH UP TO (LV)			
1000 mm (39 ³ / ₈ "	H-BMI2-1000	H-BML2-1000	H-BMV2-1000
1200 mm (47 ¹ / ₄ "	H-BMI2-1200	H-BML2-1200	H-BMV2-1200
1400 mm (55 ¹ / ₈ "	H-BMI2-1400	H-BML2-1400	H-BMV2-1400
1600 mm (63"	H-BMI2-1600	H-BML2-1600	H-BMV2-1600
1800 mm (70 ³ / ₈ "	H-BMI2-1800	H-BML2-1800	H-BMV2-1800
2000 mm (78 ³ / ₈ "	H-BMI2-2000	H-BML2-2000	H-BMV2-2000

■ Larghezza max. anta "master" = 1200 mm - Larghezza min. anta "slave" = 300 mm
■ Anta "slave" min. 500 mm

■ "Master" leaf max. width = 1200 mm (47¹/₄") - "slave" leaf min. width - 300 mm (11³/₈")
■ "Slave" manual leaf min. 500 mm (19³/₈")

NOTA: Disponibile in versione ad ante simmetriche ed asimmetriche

REMARKS: Available in version with symmetrical and asymmetrical leaves

KIT	
Kit trasf. servoassistita con batteria con braccio BDT (a tirare) <i>Servo-assisted transformation kit with battery with BDT pull arm</i>	H-KNEXT-BDT
Kit trasf. servoassistita con batteria con braccio BDS (a spingere) <i>Servo-assisted transformation kit with battery with BDS push arm</i>	H-KNEXT-BDS
Kit trasf. servoassistita con batteria con braccio BAS (articolato a spingere) <i>Servo-assisted transformation kit with battery with articulated push arm (BAS)</i>	H-KNEXT-BAS
Kit trasformazione a tenuta ermetica - ■ H-BMI2 - ■ H-BML2 - Applicabile per larghezza anta da 340 a 1230 mm <i>Hermetic seal conversion kit - ■ H-BMI2 - ■ H-BML2 - Applicable for 340 to 1230 mm leaf width (13³/₈" to 48³/₈")</i>	H-KBEM2

Elementi Opzionali da ordinare separatamente al momento dell'ordine
Optional items to be ordered separately at time of order

Colorazioni e finiture speciali <i>Special colours and finishes</i>	Fasce / Bands	Rivestimenti gruppo copertura <i>Covering unit cladding</i>	Visiva / Vision panel	Tendine elettriche e manuali <i>Manual and electric blinds</i>	Piombature <i>Lead foils</i>
pag./page 120	pag./page 103	pag./page 102	pag./page 96	pag./page 96	pag./page 104
Maniglie e maniglioni per porte scorrevoli <i>Handle for Sliding Door</i>	Maniglie per porte manuali a battente <i>Level handle for manual swing door</i>	Serrature <i>Mechanical Lock</i>	Dispositivi di impulso (se diversi da quelli standard) <i>Pulse devices (if other than the standard ones)</i>	Batterie di apertura in emergenza <i>Emergency opening batteries</i>	Imbotti e semi-imbotti <i>Wall frame and semi-wall frame</i>
pag./page 108	pag./page 109	pag./page 110	pag./page 117	pag./page 118	pag./page 100

■ Acciaio / ST. Steel ■ Laminato / HPL ■ Vetro / Glass

■ H-BMI2

■ H-BML2

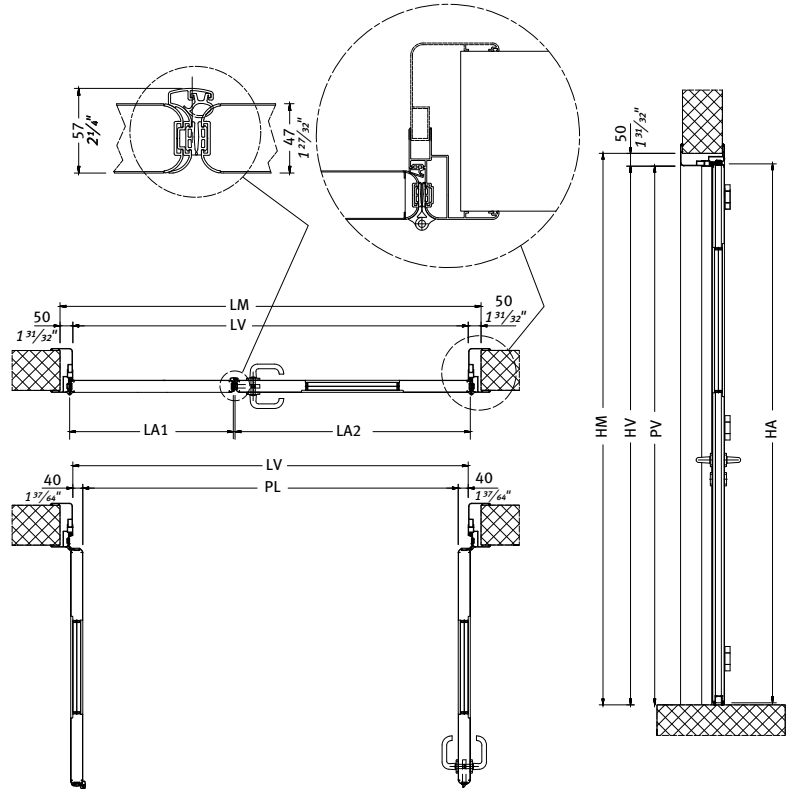
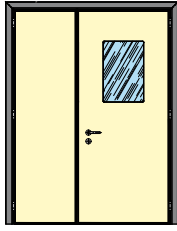
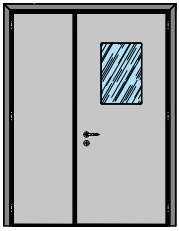

■ H-BMV2

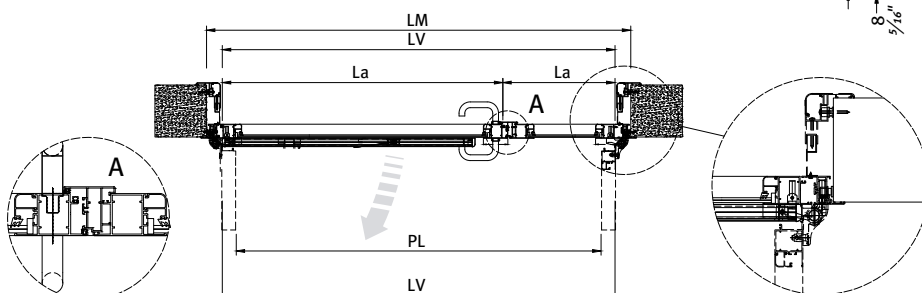
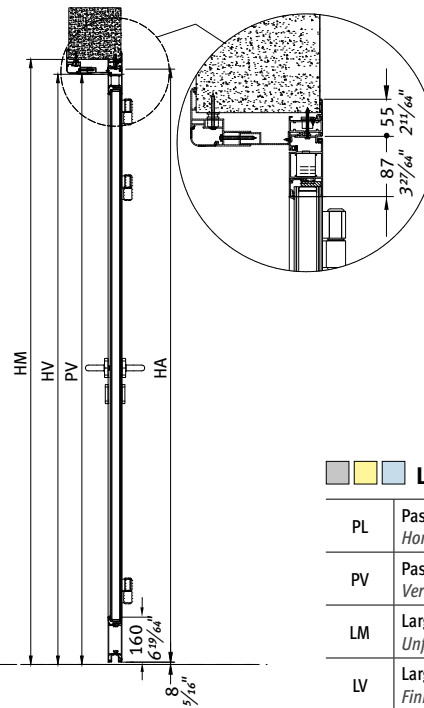
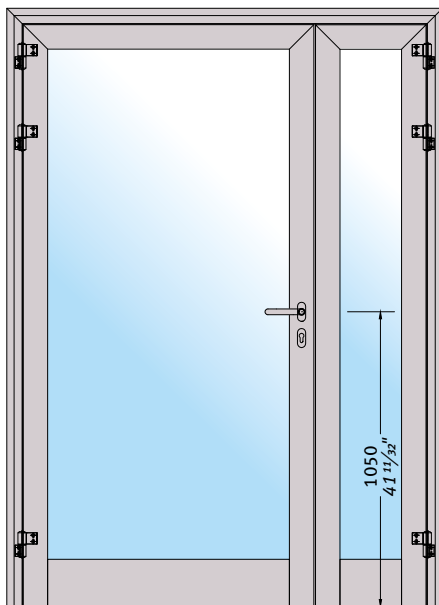

■ ■ ■ **Legenda / Key**

PL	Passaggio netto orizzontale <i>Horizontal net passage</i>
PV	Passaggio netto verticale <i>Vertical net passage</i>
LM	Larghezza vano grezzo <i>Unfinished opening width</i>
LV	Larghezza vano finito <i>Finished opening width</i>
LA	Larghezza anta <i>Leaf width</i>
HM	Altezza vano grezzo <i>Unfinished opening height</i>
HV	Altezza vano finito <i>Finished opening height</i>
HA	Altezza anta <i>Leaf height</i>



Porta manuale a battente con lastre in piombo - 1 anta
Manual swing door with lead plates - 1 leaf

Tenuta semplice - PB / Simple seal - PB

1 ANTA / 1 LEAF

LASTRA DI PIOMBO LEAD PLATE	LARGHEZZA VANO FINO A (LV) OPENING WIDTH UP TO (LV)	PANNELLO INOX STAINLESS STEEL PANEL	PANNELLO LAMINATO HPL PANEL
Pb 1 mm (1/16")	800 mm (31 1/2")	H-BMI1-800 1PB	H-BML1-800 1PB
Pb 1 mm (1/16")	900 mm (35 5/16")	H-BMI1-900 1PB	H-BML1-900 1PB
Pb 1 mm (1/16")	1000 mm (39 3/8")	H-BMI1-1000 1PB	H-BML1-1000 1PB
Pb 1 mm (1/16")	1100 mm (43 5/16")	H-BMI1-1100 1PB	H-BML1-1100 1PB
Pb 1 mm (1/16")	1200 mm (47 1/4")	H-BMI1-1200 1PB	H-BML1-1200 1PB
Pb 2 mm (1/8")	800 mm (31 1/2")	H-BMI1-800 2PB	H-BML1-800 2PB
Pb 2 mm (1/8")	900 mm (35 5/16")	H-BMI1-900 2PB	H-BML1-900 2PB
Pb 2 mm (1/8")	1000 mm (39 3/8")	H-BMI1-1000 2PB	H-BML1-1000 2PB
Pb 2 mm (1/8")	1100 mm (43 5/16")	H-BMI1-1100 2PB	H-BML1-1100 2PB
Pb 2 mm (1/8")	1200 mm (47 1/4")	H-BMI1-1200 2PB	H-BML1-1200 2PB
Pb 3 mm (3/16")	800 mm (31 1/2")	H-BMI1-800 3PB	H-BML1-800 3PB
Pb 3 mm (3/16")	900 mm (35 5/16")	H-BMI1-900 3PB	H-BML1-900 3PB
Pb 3 mm (3/16")	1000 mm (39 3/8")	H-BMI1-1000 3PB	H-BML1-1000 3PB
Pb 3 mm (3/16")	1100 mm (43 5/16")	H-BMI1-1100 3PB	H-BML1-1100 3PB
Pb 3 mm (3/16")	1200 mm (47 1/4")	H-BMI1-1200 3PB	H-BML1-1200 3PB

NOTA: Per ogni tipologia di porta è necessario specificare l'apertura se "A SPINGERE" o "A TIRARE" con riferimento visto lato automazione. Prezzi validi per porte a battenti con altezza vano (HV) = fino a 2150 mm.

NOTE: For every type you must specify the type of opening, whether "PUSH" or "PULL", as seen from the operator side. Prices valid for swing doors with opening heights (HV) up to 2150 mm (84%).

KIT	
Kit trasformazione a tenuta ermetica <i>Hermetic seal conversion kit</i>	H-KBEM1

È NECESSARIO ABBINARE UN CHIUDIPORTA AEREO, DI PRESTAZIONI ADEGUATE ALLE DIMENSIONI ED AL PESO DELLA PORTA.
GLI AREA MANAGER LABEL SARANNO LIETI DI PROPORVI LA SOLUZIONE IDEALE.
IT IS NECESSARY TO PAIR AN OVERHEAD DOOR CLOSER, WITH A PERFORMANCE SUITABLE FOR THE SIZE AND WEIGHT OF THE DOOR.
LABEL AREA MANAGERS WILL BE GLAD TO PROPOSE YOU THE IDEAL SOLUTION.

IMPORTANTE: La lastra di piombo è presente solo nel pannello e nel telaio. L'imbotte o l'estensione imbotte (se previste nella fornitura) non sono MAI dotate di lastra di piombo. Schermatura del muro/parete non di competenza LABEL.
IMPORTANT: The lead plate is present in the panel and the frame only. The wall frame or wall frame extension (if provided for in the supply) is NEVER equipped with a lead plate. Wall protection not in LABEL scope.



Porta manuale a battente con lastre in piombo - 2 ante
Manual swing door with lead plates - 2 leaves

LASTRA DI PIOMBO LEAD PLATE	LARGHEZZA VANO FINO A (LV) OPENING WIDTH UP TO (LV)	PANNELLO INOX STAINLESS STEEL PANEL	PANNELLO LAMINATO HPL PANEL
Pb 1 mm (1/16")	1000 mm (39 3/8")	H-BMI2-1000 1PB	H-BML2-1000 1PB
Pb 1 mm (1/16")	1200 mm (47 1/4")	H-BMI2-1200 1PB	H-BML2-1200 1PB
Pb 1 mm (1/16")	1400 mm (55 1/8")	H-BMI2-1400 1PB	H-BML2-1400 1PB
Pb 1 mm (1/16")	1600 mm (63")	H-BMI2-1600 1PB	H-BML2-1600 1PB
Pb 1 mm (1/16")	1800 mm (70 7/8")	H-BMI2-1800 1PB	H-BML2-1800 1PB
Pb 1 mm (1/16")	2000 mm (78 3/4")	H-BMI2-2000 1PB	H-BML2-2000 1PB
Pb 2 mm (1/8")	1000 mm (39 3/8")	H-BMI2-1000 2PB	H-BML2-1000 2PB
Pb 2 mm (1/8")	1200 mm (47 1/4")	H-BMI2-1200 2PB	H-BML2-1200 2PB
Pb 2 mm (1/8")	1400 mm (55 1/8")	H-BMI2-1400 2PB	H-BML2-1400 2PB
Pb 2 mm (1/8")	1600 mm (63")	H-BMI2-1600 2PB	H-BML2-1600 2PB
Pb 2 mm (1/8")	1800 mm (70 7/8")	H-BMI2-1800 2PB	H-BML2-1800 2PB
Pb 2 mm (1/8")	2000 mm (78 3/4")	H-BMI2-2000 2PB	H-BML2-2000 2PB
Pb 3 mm (3/8")	1000 mm (39 3/8")	H-BMI2-1000 3PB	H-BML2-1000 3PB
Pb 3 mm (3/8")	1200 mm (47 1/4")	H-BMI2-1200 3PB	H-BML2-1200 3PB
Pb 3 mm (3/8")	1400 mm (55 1/8")	H-BMI2-1400 3PB	H-BML2-1400 3PB
Pb 3 mm (3/8")	1600 mm (63")	H-BMI2-1600 3PB	H-BML2-1600 3PB
Pb 3 mm (3/8")	1800 mm (70 7/8")	H-BMI2-1800 3PB	H-BML2-1800 3PB
Pb 3 mm (3/8")	2000 mm (78 3/4")	H-BMI2-2000 3PB	H-BML2-2000 3PB

NOTA: Per ogni tipologia di porta è necessario specificare l'apertura se "A SPINGERE" o "A TIRARE" con riferimento vista lato automazione.
Larghezza max. anta motorizzata = 1200 mm - Larghezza min. anta manuale = 300 mm
Prezzi validi per porte a battenti con altezza vano (HV) = fino a 2150 mm.

NOTE: For every type you must specify the type of opening, whether "PUSH" or "PULL", as seen from the operator side.
"Master" leaf max. width = 1200 mm (47 1/4") - "slave" leaf min. width = 300 mm (11 3/4")
Prices valid for swing doors with opening heights (HV) up to 2150 mm (84 5/8").

KIT (Applicabile per larghezza anta da 340 a 1230 mm / *Applicable for 340 to 1230 mm leaf width (13 3/8" to 48 7/8")*)



Kit trasformazione a tenuta ermetica
Hermetic seal conversion kit

H-KBEM2

È NECESSARIO ABBINARE UN CHIUDIPORTA AEREO, DI PRESTAZIONI ADEGUATE ALLE DIMENSIONI ED AL PESO DELLA PORTA.

GLI AREA MANAGER LABEL SARANNO LIETI DI PROPORVI LA SOLUZIONE IDEALE.

IT IS NECESSARY TO PAIR AN OVERHEAD DOOR CLOSER, WITH A PERFORMANCE SUITABLE FOR THE SIZE AND WEIGHT OF THE DOOR.

LABEL AREA MANAGERS WILL BE GLAD TO PROPOSE YOU THE IDEAL SOLUTION.

IMPORTANTE: La lastra di piombo è presente solo nel pannello e nel telaio. L'imbotte o l'estensione imbotte (se previste nella fornitura) non sono MAI dotate di lastra di piombo. Schermatura del muro/parete non di competenza LABEL.

IMPORTANT: The lead plate is present in the panel and the frame only. The wall frame or wall frame extension (if provided for in the supply) is NEVER equipped with a lead plate. Wall protection not in LABEL scope.



PORTE
SALVASPAZIO

*SPACE SAVING
DOORS*



Le porte salvaspazio Label sono state progettate per garantire il massimo spazio libero di passaggio e rendere efficienti e tecnologici anche quegli accessi in cui non vi è lo spazio sufficiente per utilizzare porte con apertura standard a battente o scorrevole.
Le porte salvaspazio Label sono **sicure, durevoli, a basso consumo energetico** e si suddividono in due diverse tipologie:

- **lineare** con chiusura **telescopica**,
- **pieghevole** con chiusura **a libro**.

Il sistema porta è composto da automazioni con motore brushless di ultima generazione e da un sistema di profili elegante, solido e di minimo ingombro. Il risultato è una porta moderna e elegante che lascia uno spazio di passaggio equivalente a quello di un normale ingresso automatico.

Sono disponibili in diverse versioni:

- **antipanico a sfondamento** per vie di fuga
- con **vetrazione**
- con pannellatura in **laminato o acciaio inox**
- con **profili colorati** (ampia gamma di colori disponibili)

Operatore conforme alle norme europee

Automation in compliance with European standards

EN 16005; EN 13849-1; EN 13849 -2; EN 61000-6-2; EN 61000-6-3;
EN 60335-2-103; DIN 18650-1; DIN 18650-2



Label space-saving doors are designed to provide maximum passage opening and make efficient and technological also those entrances where there is not enough space to use standard swing or sliding doors. Label space-saving doors are secure, durable, energy-efficient and are available in two different types:





- **linear** with **telescopic closure**,
- **folding** with **folding closure**.

The door system is composed of automations with latest generation brushless motor and an elegant, solid, and space-saving system of profiles. The result is a modern, stylish door, that leaves a passage opening equivalent to that of a standard automatic entrance.

They are available in different versions:

- **breakout system** for escape routes
- with **glazing**
- with panels in **HPL or stainless steel**
- with **colour profiles** (wide range of colours available)

LEGENDA PITTOGRAMMI TABELLE - TABLES PICTOGRAMS LEGEND

	Codice Code		Descrizione Description		Spessore muro Wall thickness		Confezione Package
	Funzionamento Automatico Automatic operation		Funzionamento Manuale Manual operation		Tenuta Ermetica Hermetic seal		Tenuta Semplice Simple seal
	Battente Swing		Anta Leaf		Scorrevole Sliding		Finitura Finish

LEGENDA PREZZI

I prezzi sono espressi in € e indicano il prezzo unitario o il prezzo al metro

Esempio: 5,00 = (prezzo unitario)
Esempio: 5,00/m = (prezzo al metro)





PRICES LEGEND

Prices are in € and indicate the unit price or the price per meter

Example: 5,00 = (unit price)
Example: 5,00/m = (price per meter)





PORTE SCORREVOLI TELESCOPICHE AUTOMATICHE

La porta si muove orizzontalmente e, in prossimità della chiusura, va in appoggio sui montanti ed il traverso del telaio sporgente a muro garantendo, mediante la compressione di speciali guarnizioni in gomma presenti sui due lati verticali e sul lato orizzontale superiore della porta, la tenuta all'aria. I carrelli di sostegno possono supportare e spostare un carico massimo di 300 kg per porta ad anta singola. L'automazione è inoltre dotata di specifico software in grado di fornire potenza aggiuntiva nella movimentazione di porte.

Pannelli	Inclusi
	Automazione ETH/T con motore BRUSHLESS: <ul style="list-style-type: none"> Automazione su trave da 78 mm, copertura ispezionabile in alluminio e fianchetti laterali in ABS Gruppo copertura da mm 210x120H in lega di alluminio con articolazione per sgancio e supporto Automazione per una o due ante scorrevoli Portata massima di 400 kg per porta a doppia anta o 300 kg per porta ad anta singola Lunghezza massima dell'automazione: 6500 mm Rotaia di scorrimento in lega di alluminio sospesa su guarnizione in gomma anti-rumore Motore BRUSHLESS, scatola ingranaggi reversibile Trasmissione del movimento mediante cinghia dentata in gomma con cordoli in kevlar, antistatica Carrelli a doppia ruota con dispositivo anti-deragliamento Unità di controllo con microprocessore ad auto-apprendimento e gestione automatica delle procedure di sicurezza (anti-schiacciamento, inversione di direzione, movimento di sicurezza a bassa velocità)
	Pannello anta completo di cornici e guarnizioni dedicate
	Gruppo copertura in alluminio nella versione con finitura grezza
	Programmatore digitale
	Sensori di sicurezza (Qt. 2)

DOORS - SLIDING TELESCOPIC AUTOMATIC

The door moves horizontally and, when it is nearly closed, it comes to rest against the uprights and the crossbar of the frame, which extends out from the wall, ensuring, through the compression of special rubber gaskets on the two vertical sides and the top horizontal side of the door, an airtight seal. The support trolleys can bear and convey a maximum load of 300 kg (661lb) per single-leaf door. The automation is also equipped with a specific type of software that is able to provide additional power when operating heavy doors.

Panels	Includes
	ETH/T automation with BRUSHLESS motor: <ul style="list-style-type: none"> Automation on 78 mm (3¹/₁₆") transom, aluminium cover accessible for inspection, ABS side caps Aluminium alloy covering unit, 210x120H mm (8³/₄" x 4³/₄"), with release and support articulation Automation for one or two sliding leaves. Maximum load capacity of 400 kg (881lb) for a double-leaf door or 300 kg (661lb) for a single-leaf door Maximum automation length: 6500 mm (255¹⁵/₁₆") Aluminium alloy slideway rail mounted on a sound-dampening rubber gasket BRUSHLESS motor, reversible gearbox The movement is driven by a rubber antistatic timing belt with Kevlar sides Double-wheel trolleys with anti-derailment device Control unit with self-learning microprocessor and automatic management of safety procedures (anti-crushing, direction reversal, low-speed safety movement)
	Leaf panel complete with dedicated frames and gaskets
	Aluminium covering unit in the raw-aluminium version
	Digital selector
	Safety sensors (Qty. 2)



 Acciaio / ST.Steel  Laminato / HPL

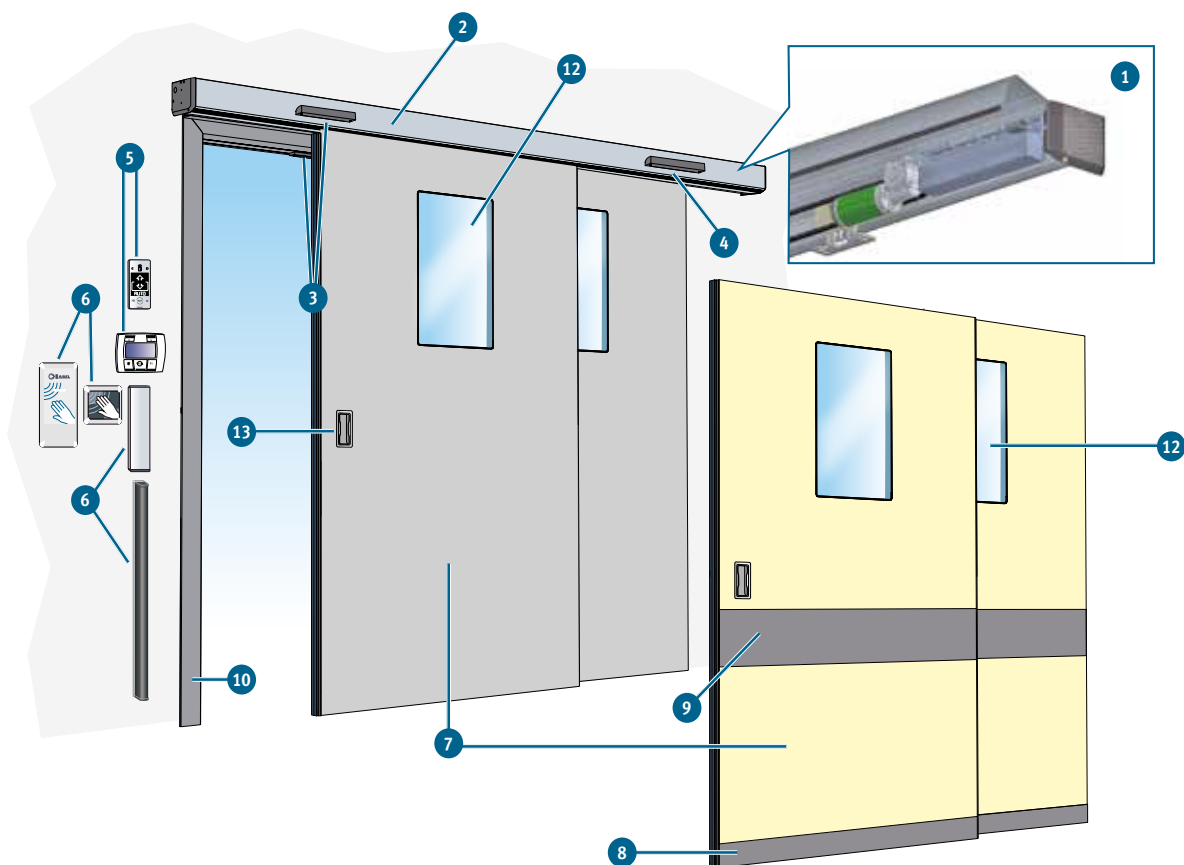

Legenda / Key

1 Gruppo automazione / Automation unit

2 Gruppo copertura / Cladding unit

3 Sensore di sicurezza in chiusura / Closing safety sensor

4 Sensore di sicurezza in apertura opzionale
Optional opening safety sensor

5 Programmatore digitale / Digital programmer

6 Dispositivi di attivazione / Activation devices

7 Pannello / Panel

8 Zoccolo / Base

9 Fascia orizzontale / Horizontal band

10 Imbotte (o semi-imbotte) opzionale
Optional wall frame (or semi-wall frame)

12 Visiva (opzionale) / Vision panel (optional)

13 Maniglia / Handle (page 108)



Porta scorrevole telescopica automatica - 2 ante
Automatic, telescopic sliding door - 2 leaves

AUTOMAZIONE ETH/T ETH/T AUTOMATION	HB-TAITS2	HB-TALTS2
	PANNELLO INOX STAINLESS STEEL PANEL	PANNELLO LAMINATO HPL PANEL
LARGHEZZA VANO FINO A (LV) OPENING WIDTH UP TO (LV)		
1200 mm (47¼")	HB-TAITS2-1200	HB-TALTS2-1200
1400 mm (55½")	HB-TAITS2-1400	HB-TALTS2-1400
1600 mm (63")	HB-TAITS2-1600	HB-TALTS2-1600
1800 mm (70¾")	HB-TAITS2-1800	HB-TALTS2-1800
2000 mm (78¾")	HB-TAITS2-2000	HB-TALTS2-2000

Elementi Opzionali da ordinare separatamente al momento dell'ordine
Optional items to be ordered separately at time of order

Colorazioni e finiture speciali Special colours and finishes	Fasce / Bands	Rivestimenti gruppo copertura Covering unit cladding	Visiva / Vision panel	Tendine elettriche e manuali Manual and electric blinds	Piombature Lead foils
pag./page 120	pag./page 103	pag./page 102	pag./page 96	pag./page 96	pag./page 104
Maniglie e maniglioni per porte scorrevoli Handle for Sliding Door	Maniglie per porte manuali a battente Level handle for manual swing door	Serrature Mechanical Lock	Dispositivi di impulso (se diversi da quelli standard) Pulse devices (if other than the standard ones)	Batterie di apertura in emergenza Emergency opening batteries	Imbotti e semi-imbotti Wall frame and semi-wall frame
pag./page 108	pag./page 109	pag./page 110	pag./page 117	pag./page 118	pag./page 100

■ HB-TAITS2 ■ HB-TALTS2

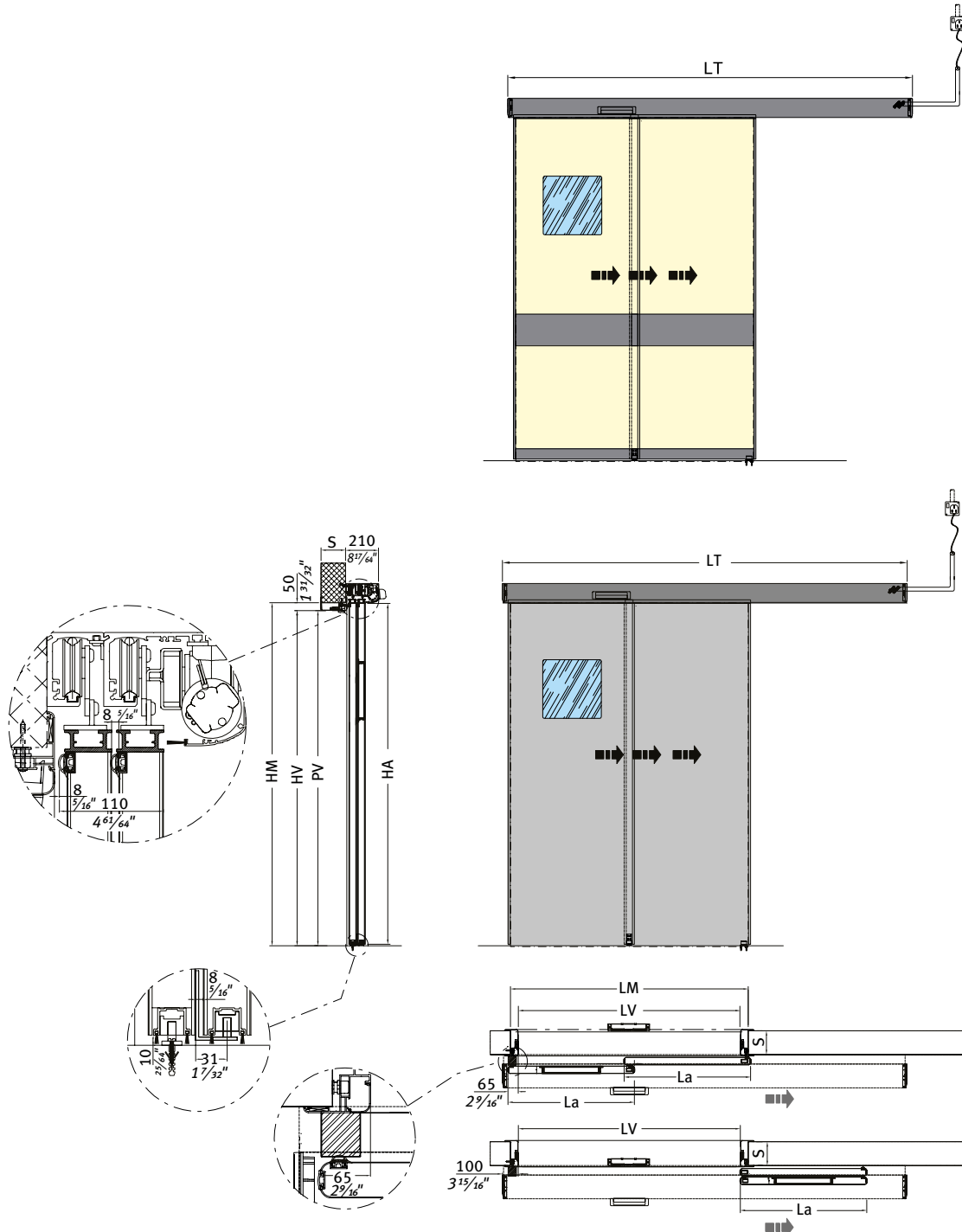

■ ■ **Legenda / Key**

PL	Passaggio netto orizzontale Horizontal net passage	LM	Larghezza vano grezzo Unfinished opening width	HM	Altezza vano grezzo Unfinished opening height	HA	Altezza anta Leaf height
PV	Passaggio netto verticale Vertical net passage	LV	Larghezza vano finito Finished opening width	HV	Altezza vano finito Finished opening height	S	Spessore muro Wall thickness
LT	Lunghezza automazione Automation length	LA	Larghezza anta Leaf width				

PORTE AUTOMATICHE A SOFFIETTO

Porta automatica ad ante pieghevoli con o senza sistema antipanico caratterizzata da una struttura portante in alluminio estruso facilmente assemblabile per facilitare le operazioni di trasporto e montaggio. Le ante mobili sono realizzate con profili in alluminio a sezione ridotta arrotondati che offrono ampia luminosità e sicurezza antinfortunistica. Assenza di cerniere a vista e movimentazione con l'ausilio di cuscinetti a rullini. Trascinamento ante mediante automazione LABEL a rotazione per porte automatiche corredato di sistemi di sicurezza rispondenti alle norme vigenti. Sistema controllo forze di impatto meccanico regolabile. Sistema di apertura antipanico a sfondamento APN indicato per le vie di fuga con aggancio ante magnetico regolabile (testato dall'Istituto Giordano con rapporto di convalida N. 309537).

AUTOMATIC FOLDING DOORS

Automatic door with folding leaves, with or without breakout system, featuring a load-bearing structure in extruded aluminium, easily assemblable to ease transport and assembly operations. Mobile leaves are realized with rounded aluminium profiles with reduced section, which provide great luminosity and safety. No visible hinge and motion by means of roller bearings. Leaf drive by means of rotary LABEL automation for automatic doors, provided with safety systems which comply with the applicable standards. Adjustable system to control mechanical impact forces. APN breakout system for escape routes with adjustable magnetic lock of leaves (tested by Istituto Giordano with validation report no. 309537).



Pannelli	Descrizione
	<ul style="list-style-type: none"> • Modello: SF1000 new (porta automatica ad ante pieghevoli) • Numero ante: 4 ante (2 dx - 2 sx) • Profili: Profili in lega di alluminio UNI 6060 • Dimensione profili ante mobili: - Verticali 25x35 mm arrotondati - Orizzontali 60x35 mm • Struttura portante: - Verticali 80x40 mm. - Orizzontali 158x291 mm • Dimensioni realizzabili: Vano passaggio utile max 1800x2400 mm • Sistema di apertura antipanico (U.S.): A sfondamento con aggancio magnetico • Tenuta all'aria: Tramite spazzolini perimetrali (disponibile anche con guarnizione in gomma silconica atossica su richiesta) • Pannellatura ante: - Spessore: max 28 mm - Peso ante: 45 kg/cd max • Vetro: standard 44,2 mm • Alimentazione: 220-240 Vac 50 Hz 150W

Panels	Description
	<ul style="list-style-type: none"> • Model: SF1000 new (automatic door with foldable leaves) • Number of leaves: 4 leaves (2 rh - 2 lh) • Profiles: Profiles in aluminium alloy UNI 6060 • Dimensions of mobile leaves profiles: - Vertical 25x35 mm (1" x 1 3/8") rounded - Horizontal 60x35 mm (2 3/8" x 1 3/8") • Load-bearing structure: - Vertical 80x40 mm (3 1/8" x 1 9/16") - Horizontal 158x291 mm (6 3/4" x 11 7/16") • Possible dimensions: Max. useful passage opening 1800x2400 mm (70 7/8" x 94 1/2") • Anti-panic opening system (U.S.): Breakout type with maglock • Air tightness: By means of perimeter brushes (also available on request with non-toxic silicone rubber gasket) • Leaves panels: - Thickness: max 28 mm (1 1/8") - Leaves weight: 45 kg (99lb)/cd max • Glazing: standard 44.2 mm or 8 mm (5/16") • Power supply: 220-240 Vac 50 Hz 150W



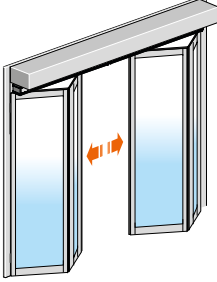

Porta automatica a soffietto - 4 ante
Automatic folding door - 4 leaves

<p>AUTOMAZIONE ETH/D ETH/D AUTOMATION</p>	 	
	<p>HB-SOF-FTA</p>	<p>FTA Porta automatica a soffietto senza sistema antipanico <i>FTA Automatic folding door without breakout system</i></p>
	<p>HB-SOF-FBO</p>	<p>FBO Porta automatica a soffietto x uscita di sicurezza con sistema antipanico <i>FBO Automatic folding door for safety exit with breakout system</i></p>

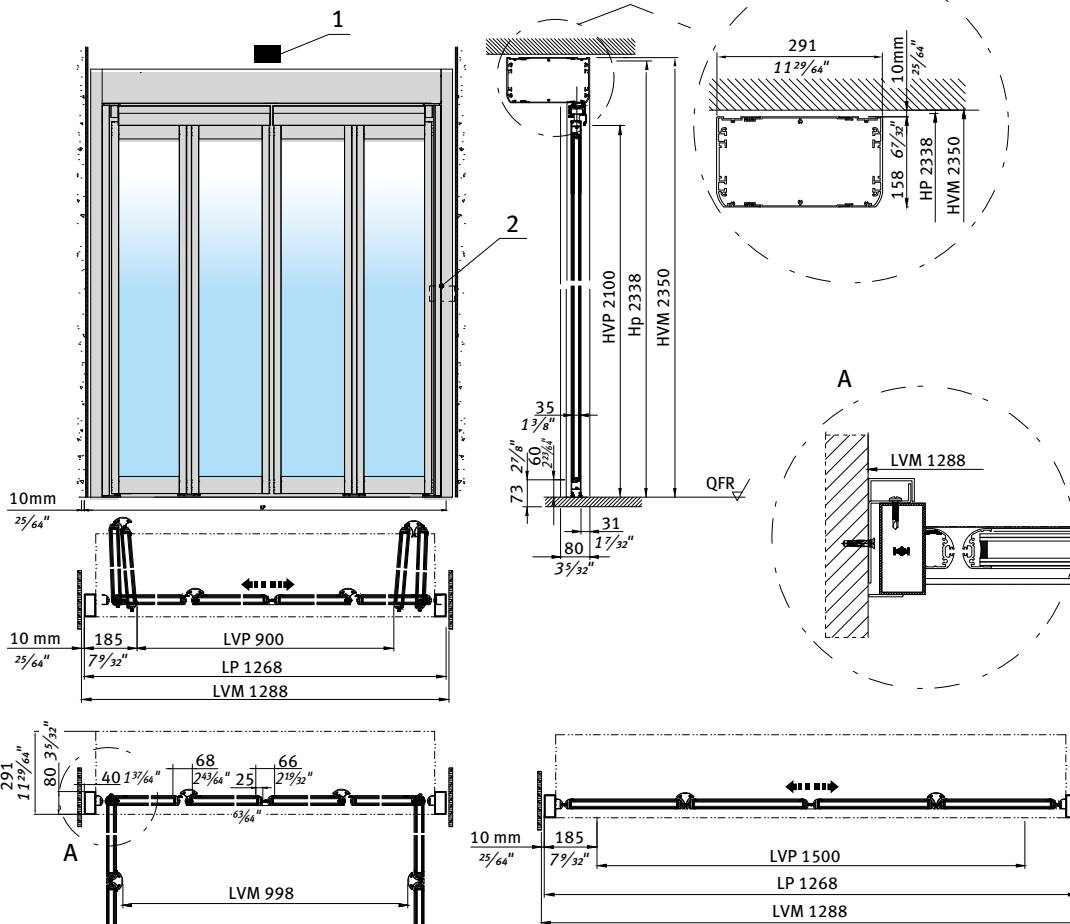

Legenda / Key

<p>1 Dispositivo di impulso e sicurezza (interno) <i>Pulse and safety device (internal)</i></p>	<p>2 Selettore a chiave o programmatore <i>Key selector or programmer</i></p>
---	---



PORTE VETRATE ICU-CCU

ICU-CCU GLAZED DOORS

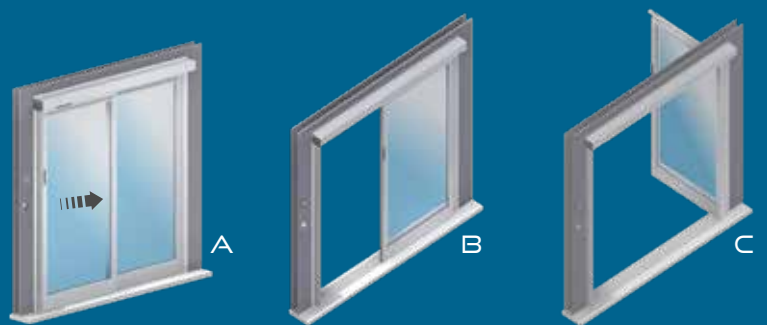

Le porte Label ICU-CCU, porte Automatiche e Manuali scorrevoli (A-B) e porta con dispositivo TLCA, che rende completamente libero il vano luce (C)
ICU-CCU Label doors, sliding automatic and manual doors (A-B) and door with TLCA device, which enables full passage opening (C)

PORTA VETRATA AUTOMATICA SCORREVOLE CON DISPOSITIVO TLCA PER ICU-CCU

Porte ospedaliere per terapia intensiva e sub-intensiva

Le porte **Label ICU-CCU** sono porte Automatiche e Manuali ad anta/ante scorrevole lineare che scorre su un laterale/laterali. Il sistema non prevede binari guida incassati o in superficie ed è interamente vetrato.

La **porta-TLCA** (Total Light Compartment Accessible) è una porta Automatica ad anta/ante scorrevole con dispositivo TLCA, che rende completamente libero il vano luce, agevolando il passaggio di grandi volumi. Il sistema non prevede binari guida incassati o in superficie e facilita il trasporto del letto, dell'attrezzatura e del paziente. Per ottenere la luce totale disponibile è sufficiente far scorrere la porta per aprirla completamente e ruotarla comodamente in posizione di sfondamento.

La gamma è formata da:

- **HB-SAVTE101** (porta scorrevole automatica vetrata a tenuta ermetica)
- **HB-SAVTS101** (porta scorrevole automatica vetrata a tenuta semplice)
- **H-SMVTE101** (porta scorrevole manuale vetrata a tenuta ermetica)
- **H-SMVTS101** (porta scorrevole manuale vetrata a tenuta semplice)
- **HB-SAVTLCA1** (porta automatica scorrevole vetrata con laterale apribile a tenuta semplice)
- **H-SMVTLCA1** (porta manuale scorrevole vetrata con laterale apribile a tenuta semplice)

Progettate per gli ambienti ICU/CCU di prossima generazione, tutte le versioni sono disponibili con la funzione **Smart Glass**.

Lo **Smart Glass** è la nuova tecnologia elettronica che integrata al vetro, lo opacizza attraverso un comando elettrico. Questa soluzione fornisce livelli più elevati di privacy del paziente, comodità e di controllo da parte del personale Ospedaliero.

Tenuta pressione

Le porte ICU/CCU sono a tenuta standard per pressione positiva o negativa.

Accessori

Le porte per terapia intensiva possono essere corredate di un'ampia gamma di accessori: pulsanti contactless, pulsanti a gomito, maniglie, sensori, Smart-glass.

Ambiti di utilizzo

Terapia intensiva e sub-intensiva

GLAZED AUTOMATIC SLIDING DOOR WITH TLCA DEVICE FOR ICU-CCU

Hospital doors for intensive and sub-intensive care environments.

Label ICU-CCU doors are Automatic and Manual doors with linear sliding leaf/leaves sliding on side screen/s. The system does not have recessed or surface floor guides and is entirely glazed.

The **TLCA** (Total Light Compartment Accessible) door is an Automatic door with sliding leaf/leaves with TLCA device, which makes the passage opening completely free, facilitating the passage of large volumes. The system has no recessed or surface floor guides and facilitates the transport of bed, equipment, and patient. To get the total available opening passage, simply slide the door to open it completely and turn it comfortably to the break-out position.

The range consists of:

- **HB-SAVTE101** (automatic hermetically sealing glazed sliding door)
- **HB-SAVTS101** (automatic simple sealing glazed sliding door)
- **H-SMVTE101** (manual hermetically sealing glazed sliding door)
- **H-SMVTS101** (manual simple sealing glazed sliding door)
- **HB-SAVTLCA1** (simple sealing glazed automatic sliding door with side screen)
- **H-SMVTLCA1** (simple sealing glazed manual sliding door with openable side screen)

Designed for next generation ICU/CCU environments, all versions are available with **Smart Glass** function. **Smart Glass** is the new electronic technology integrated in the glass, which makes it opaque through an electric control. This solution provides higher levels of patient privacy, comfort, and control by hospital staff.

Pressure seal

ICU/CCU ports are standard sealed for positive or negative pressure.

Accessories







The ICU doors can be equipped with a wide range of accessories: contactless buttons, elbow buttons, handles, sensors, Smart-glass.

Areas of use

Intensive and sub-intensive care.



Porta vetrata automatica scorrevole con laterale fisso - ICU-CCU
Glazed automatic sliding door with fixed side screen - ICU-CCU

AUTOMAZIONE ETH/E-ETH <i>ETH/E-ETH AUTOMATION</i>	HB-SAVTE101	HB-SAVTS101
		 TENUTA ERMETICA <i>HERMETICALLY SEALING</i>
LARGHEZZA VANO FINO A (LV) <i>OPENING WIDTH UP TO (LV)</i>		
		
2500 mm (98 ⁷ / ₁₆ "	HB-SAVTE101-25	HB-SAVTS101-25
3000 mm (118 ¹ / ₈ "	HB-SAVTE101-30	HB-SAVTS101-30
3500 mm (137 ¹³ / ₁₆ "	-	HB-SAVTS101-35

ICU-CCU

1 ANTA / 1 LEAF

HB-SAVTE101 / HB-SAVTS101

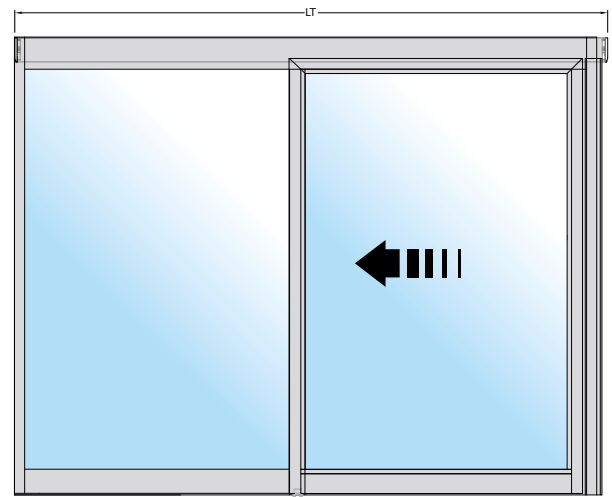
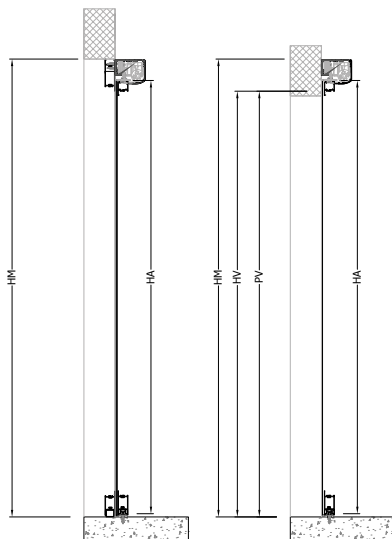





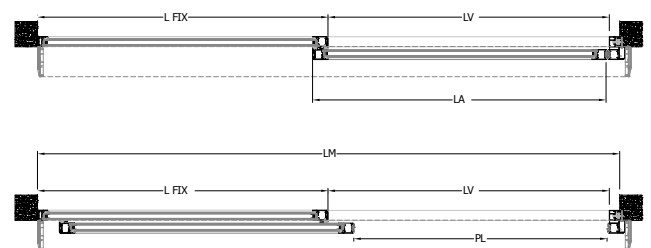

Legenda / Key

PL	Passaggio netto orizzontale <i>Horizontal net passage</i>	LA	Larghezza anta <i>Leaf width</i>
PV	Passaggio netto verticale <i>Vertical net passage</i>	HM	Altezza vano grezzo <i>Unfinished opening height</i>
LT	Lunghezza automazione <i>Automation length</i>	HV	Altezza vano finito <i>Finished opening height</i>
LM	Larghezza vano grezzo <i>Unfinished opening width</i>	HA	Altezza anta <i>Leaf height</i>
LV	Larghezza vano finito <i>Finished opening width</i>	L FIX	Laterale fisso <i>Fixed side screen</i>





Porta vetrata manuale scorrevole con laterale fisso - ICU-CCU
Glazed automatic sliding door with fixed side screen - ICU-CCU



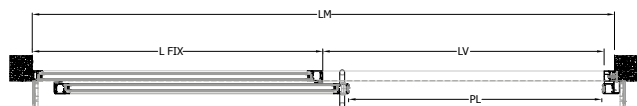
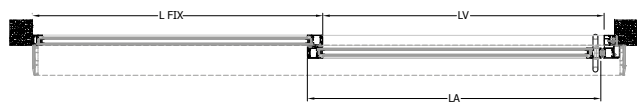
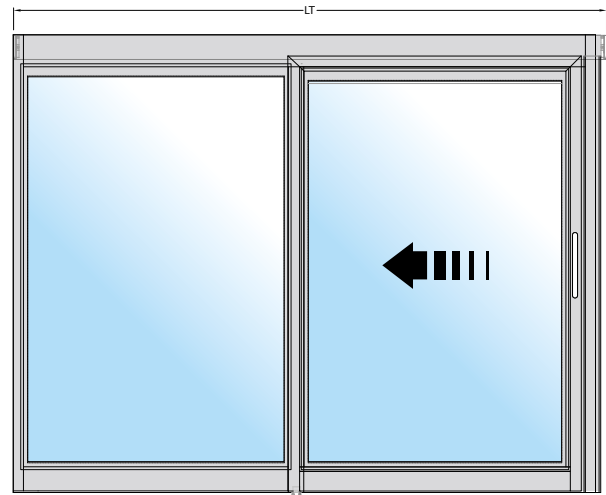
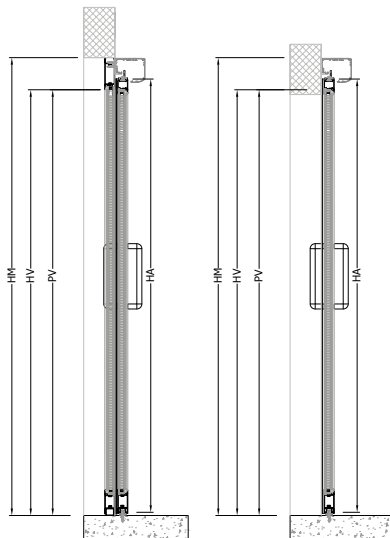

TRAVERSA MANUALE MANUAL TRANSOM	H-SMVTE101	H-SMVTS101
		 TENUTA ERMETICA HERMETICALLY SEALING
LARGHEZZA VANO FINO A (LV) OPENING WIDTH UP TO (LV)		
		
2500 mm (98 ¹ / ₁₆ "	H-SMVTE101-25	H-SMVTS101-25
3000 mm (118 ¹ / ₈ "	H-SMVTE101-30	H-SMVTS101-30

■ H-SMVTE101 / H-SMVTS101



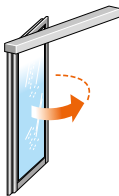









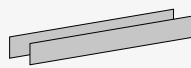
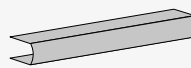

Porta vetrata scorrevole automatica e manuale con laterale apribile TLCA - ICU-CCU
Automatic sliding glazed door with openable side screen TLCA - ICU-CCU

AUTOMAZIONE ETH ETH AUTOMATION	HB-SAVTLCA1	H-SMVTLCA1 TRAVERSA MANUALE / MANUAL TRANSOM
		 TENUTA SEMPLICE <i>SIMPLE SEALING</i>
LARGHEZZA VANO FINO A (LV) OPENING WIDTH UP TO (LV)		
		
2000 mm (78 ³ / ₄ "	HB-SAVTLCA1-20	H-SMVTLCA1-20
2500 mm (98 ⁷ / ₁₆ "	HB-SAVTLCA1-25	H-SMVTLCA1-25

TLCA - ICU-CCU

1 ANTA / 1 LEAF

Elementi Opzionali da ordinare separatamente al momento dell'ordine
Optional items to be ordered separately at time of order

Colorazioni e finiture speciali <i>Special colours and finishes</i>	Fasce / Bands	Rivestimenti gruppo copertura <i>Covering unit cladding</i>	Visiva / Vision panel	Tendine elettriche e manuali <i>Manual and electric blinds</i>	Piombature <i>Lead foils</i>
pag./page 120	pag./page 103	pag./page 102	pag./page 96	pag./page 96	pag./page 104
					
Maniglie e maniglioni per porte scorrevoli <i>Handle for Sliding Door</i>	Maniglie per porte manuali a battente <i>Level handle for manual swing door</i>	Serrature <i>Mechanical Lock</i>	Dispositivi di impulso (se diversi da quelli standard) <i>Pulse devices (if other than the standard ones)</i>	Batterie di apertura in emergenza <i>Emergency opening batteries</i>	Imbotti e semi-imbotti <i>Wall frame and semi-wall frame</i>
pag./page 108	pag./page 109	pag./page 110	pag./page 117	pag./page 118	pag./page 100
					



HB-SAVTLCA1 / H-SMVTLCA1

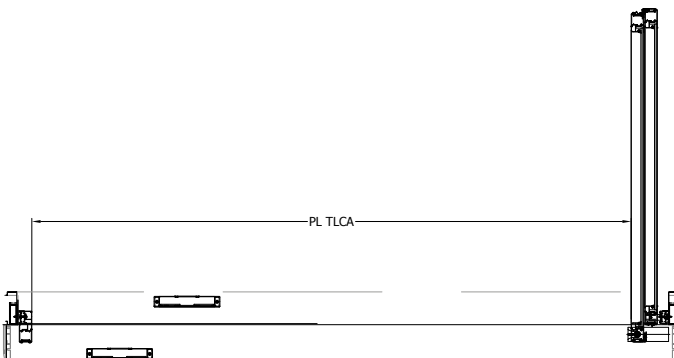
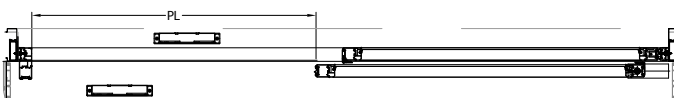
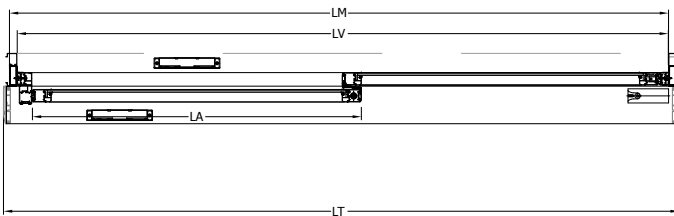
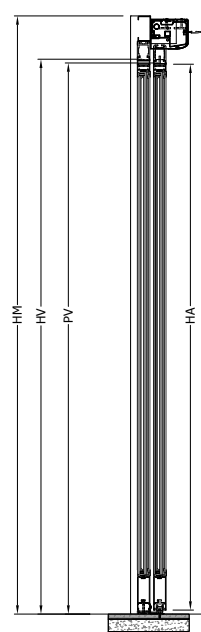
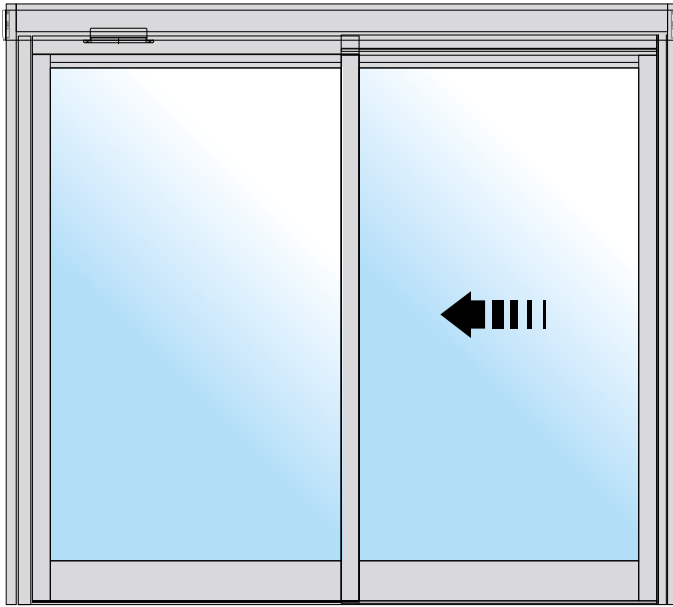

Legenda / Key

PL	Passaggio netto orizzontale <i>Horizontal net passage</i>
PV	Passaggio netto verticale <i>Vertical net passage</i>
LT	Lunghezza automazione <i>Automation length</i>
LM	Larghezza vano grezzo <i>Unfinished opening width</i>
LV	Larghezza vano finito <i>Finished opening width</i>
LA	Larghezza anta <i>Leaf width</i>
HM	Altezza vano grezzo <i>Unfinished opening height</i>
HV	Altezza vano finito <i>Finished opening height</i>
HA	Altezza anta <i>Leaf height</i>
PL TLCA	Passaggio libero ad ante aperta a 90° con laterale apribile <i>Free passage with leaves open at 90° with openable side screen.</i>



COMPONENTI
OPZIONALI

OPTIONAL
COMPONENTS



I sistemi di porte ospedaliere Label sono strutture tecnologicamente evolute e progettate per durare nel tempo.

Le porte per ospedali Label sono personalizzabili con un'ampia gamma di accessori:

- visive complanari con tendina manuale o elettrica, senza tendina
- visive complanari per porte con schermatura in piombo
- vetri standard, ad abbattimento acustico
- vetri Smart-glass LCD con funzione trasparente/opaco
- maniglie, push-bar, maniglioni alzanti, maniglioni dritti
- pulsanti di apertura, a gomito, a sfioro (contactless), a barra, di emergenza a fungo
- kit per upgrade a tenuta ermetica
- interblocchi, con segnalazioni semaforiche
- schermatura in piombo
- grafiche
- dispositivi di apertura di emergenza
- ampia gamma di colori per pannelli in laminato

Label Hospital door systems are technologically advanced products designed to last.

Label Hospital doors are customizable with a wide range of accessories:

- flush vision panels with manual or electric blind, without blind
- flush vision panels for lead-shielded doors
- standard, noise-reducing glass
- LCD smart-glass with transparent/opaque function
- handles, push-bars, lifting pull handles, straight pull handles
- elbow, contactless, bar, emergency mushroom opening buttons,
- hermetically sealing upgrade kit
- interlocks, with signaling lights
- lead shielding
- graphics
- emergency opening devices
- wide range of colours for HPL panels

LEGENDA PITTOGRAMMI TABELLE - TABLES PICTOGRAMS LEGEND

	Codice Code		Descrizione Description		Spessore muro Wall thickness		Confezione Package
	Funzionamento Automatico Automatic operation		Funzionamento Manuale Manual operation		Tenuta Ermetica Hermetic seal		Tenuta Semplice Simple seal
	Battente Swing		Anta Leaf		Scorrevole Sliding		Finitura Finish

LEGENDA PREZZI











I prezzi sono espressi in € e indicano il prezzo unitario o il prezzo al metro

Esempio: 5,00 = (prezzo unitario)
Esempio: 5,00/m = (prezzo al metro)

PRICES LEGEND





Prices are in € and indicate the unit price or the price per meter

Example: 5,00 = (unit price)
Example: 5,00/m = (price per meter)

<p>VISIVE VISION PANELS</p>			
	<p>H-VIS40</p>	<p>Visiva Vision panel</p>	<p>400x400 mm 15 3/4" x 15 3/4"</p>
	<p>H-VIS60</p>	<p>Visiva Vision panel</p>	<p>600x400 mm 23 5/8" x 15 3/4"</p>
	<p>H-VIS40RX</p>	<p>Visiva RX con protezione equivalente di 2 mm Vision panel X-ray with equivalent protection 2 mm (1/16")</p>	<p>400x400 mm 15 3/4" x 15 3/4"</p>
	<p>H-VIS60RX</p>	<p>Visiva RX con protezione equivalente di 2 mm Vision panel X-ray with equivalent protection 2 mm (1/16")</p>	<p>600x400 mm 23 5/8" x 15 3/4"</p>
	<p>H-VIS40RX3</p>	<p>Visiva RX con protezione equivalente di 3 mm Vision panel X-ray with equivalent protection 3 mm (1/8")</p>	<p>400x400 mm 15 3/4" x 15 3/4"</p>
	<p>H-VIS60RX3</p>	<p>Visiva RX con protezione equivalente di 3 mm Vision panel X-ray with equivalent protection 3 mm (1/8")</p>	<p>600x400 mm 23 5/8" x 15 3/4"</p>
	<p>H-VIS40RX4</p>	<p>Visiva RX con protezione equivalente di 4 mm Vision panel X-ray with equivalent protection 4 mm (3/16")</p>	<p>400x400 mm 15 3/4" x 15 3/4"</p>
	<p>H-VIS60RX4</p>	<p>Visiva RX con protezione equivalente di 4 mm Vision panel X-ray with equivalent protection 4 mm (3/16")</p>	<p>600x400 mm 23 5/8" x 15 3/4"</p>
<p>VISIVE CON TENDINA MANUALE VISION PANELS WITH MANUAL CURTAIN</p>			
	<p>H-VIS40TM</p>	<p>Visiva con tendina manuale Vision panel with manual curtain</p>	<p>400x400 mm 15 3/4" x 15 3/4"</p>
	<p>H-VIS60TM</p>	<p>Visiva con tendina manuale Vision panel with manual curtain</p>	<p>600x400 mm 23 5/8" x 15 3/4"</p>
	<p>H-VIS40RXTM</p>	<p>Visiva RX con tendina manuale e protezione equivalente a 2 mm Vision panel RX with manual curtain and protection equivalent to 2 mm (1/16")</p>	<p>400x400 mm 15 3/4" x 15 3/4"</p>
	<p>H-VIS60RXTM</p>	<p>Visiva RX con tendina manuale e protezione equivalente a 2 mm Vision panel RX with manual curtain and protection equivalent to 2 mm (1/16")</p>	<p>600x400 mm 23 5/8" x 15 3/4"</p>



NOTA: disponibile anche visiva con protezione equivalente a 3 e 4 mm.

NOTE: also available vision panel with protection equivalent to 3 and 4 mm (1/8" and 3/16").





VISIVE CON TENDINA ELETTRICA VISION PANELS WITH ELECTRIC CURTAIN				
	H-VIS40TE	Visiva con tendina elettrica <i>Vision panel with electric curtain</i>	400x400 mm 15 3/4" x 15 3/4"	
	H-VIS60TE	Visiva con tendina elettrica <i>Vision panel with electric curtain</i>	600x400 mm 23 3/8" x 15 3/4"	
	H-VIS40TED	Doppia visiva con tendina elettrica <i>Double vision panel with electric curtain</i>	400x400 mm 15 3/4" x 15 3/4"	
	H-VIS60TED	Doppia visiva con tendina elettrica <i>Double vision panel with electric curtain</i>	600x400 mm 23 3/8" x 15 3/4"	
	H-VIS40RXTE	Visiva RX con tendina elettrica e protezione equivalente a 2 mm <i>Vision panel X-ray with electric curtain and equivalent protection 2 mm (1/16")</i>	400x400 mm 15 3/4" x 15 3/4"	
	H-VIS60RXTE	Visiva RX con tendina elettrica e protezione equivalente a 2 mm <i>Vision panel X-ray with electric curtain and equivalent protection 2 mm (1/16")</i>	600x400 mm 23 3/8" x 15 3/4"	
	H-VIS40RXTED	Doppia visiva RX con tendina elettrica e protezione equivalente a 2 mm <i>Double vision panel X-ray with electric curtain and equivalent protection 2 mm (1/16")</i>	400x400 mm 15 3/4" x 15 3/4"	
	H-VIS60RXTED	Doppia visiva RX con tendina elettrica e protezione equivalente a 2 mm <i>Double vision panel X-ray with electric curtain and equivalent protection 2 mm (1/16")</i>	600x400 mm 23 3/8" x 15 3/4"	

NOTA: disponibile anche visiva con protezione equivalente a 3 e 4 mm.

NOTE: also available vision panel with protection equivalent to 3 and 4 mm (1/8" and 3/16").





	
H-VISM3MM	Maggiorazione per adeguamento pannello a battente piombato da 3 mm con visiva <i>Extra charge for adaptation of swing door 3 mm (1/8") lead panel with vision panel</i>

Vetri speciali per porte scorrevoli e a battente
Special glass for sliding doors and swing doors

VETRI "SMART" "SMART" GLASS			
	H-VSG	Maggiorazione per vetro 44.2 SMART GLASS <i>Additional price for glass 44.2 or 8 mm (5/16") SMART GLASS</i>	Prezzi validi per porte con altezza vano (HV) fino a 2150 mm <i>Prices valid for doors with opening heights (HV) up to 2150 mm (84 3/8")</i>
	H-VISG	Maggiorazione per vetro isolante SMART GLASS V44/27/33.2 <i>Additional price for insulating glass SMART GLASS V44 / 27 / 33.2 or 43 mm (1 3/4")</i>	Prezzi validi per porte con altezza vano (HV) fino a 2150 mm <i>Prices valid for doors with opening heights (HV) up to 2150 mm (84 3/8")</i>
	H-KVSGD *	Kit accessori per singola anta scorrevole SMART GLASS apertura destra <i>Accessory kit for single leaf sliding door SMART GLASS right opening</i>	
	H-KVSGS *	Kit accessori per singola anta scorrevole SMART GLASS apertura sinistra <i>Accessory kit for single leaf sliding door SMART GLASS left opening</i>	
	H-KVSGC *	Kit accessori per doppia anta scorrevole SMART GLASS <i>Accessory kit for double leaf sliding door SMART GLASS</i>	
	H-KVSGB1 *	Kit accessori per singola anta SMART GLASS battente singola anta <i>Accessory kit for single leaf swing door SMART GLASS</i>	
	H-KVSGB2 *	Kit accessori per singola anta SMART GLASS battente a doppia anta <i>Accessory kit for each leaf SMART GLASS double leaf swing door</i>	





* Abbinare uno di questi kit al vetro SMART desiderato. Interruttore escluso dalla fornitura. Radiocomando su richiesta.



* Pair one of these kits to the desired SMART glass. Switch not included in the supply. Radio control upon request.

VETRI GLASS		
	H-VEI	Vetro isolante 33.2 con intercapedine 18 mm (a richiesta 27 mm) <i>33.2 or 6 mm (3/4") insulating glass with 18 mm (3/4") interspace (on demand 27 mm - 1 1/4")</i>
	H-VE55.1	Vetro 55.1 <i>Glass 55.1 or 10 mm (3/8")</i>
	H-VE55.2	Vetro 55.2 <i>Glass 55.2 or 10 mm (3/8")</i>
	H-VE55.1BL	Vetro 55.1 bianco latte <i>Glass 55.1 or 10 mm (3/8") milk white</i>

Le porte vetrate vengono fornite con vetro standard 44.2. I prezzi indicati rappresentano la **MAGGIORAZIONE** prezzo da sommare al prezzo delle porta ordinata.
*Glazed doors are supplied with standard glass 44.2 or 8 mm (5/16"). The prices below are the **ADDITIONAL PRICES** to be added to the price of the door being ordered.*

Stampe per vetro porta
Prints for door glass



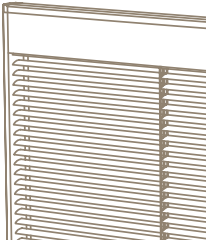
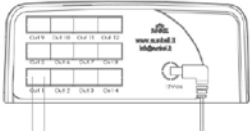
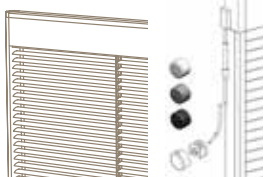
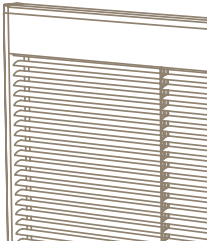
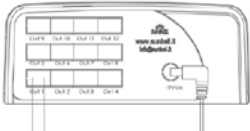

STAMPE PRINTS		
	H-FVESD	Stampa digitale <i>Digital printing</i>
	H-FVESS	Stampa serigrafica <i>Serigraph printing</i>

TENDINE CURTAINS			
 	H-KTESDX	Kit tendina elettrica con vetro isolante per porta scorrevole 1 anta - apertura destra <i>Electric curtain kit with insulating glass for sliding door, 1 leaf - RH opening</i>	da 800 mm a 1400 mm <i>800 mm to 1400 mm 31½" to 55½"</i>
	H-KTESSX	Kit tendina elettrica con vetro isolante per porta scorrevole 1 anta - apertura sinistra <i>Electric curtain kit with insulating glass for sliding door, 1 leaf - LH opening</i>	da 800 mm a 1400 mm <i>800 mm to 1400 mm 31½" to 55½"</i>
	H-KTES2	Kit tendina elettrica con vetro isolante per porta scorrevole a doppia anta - apertura centrale <i>Electric curtain kit with insulating glass for sliding double leaf door - central opening</i>	da 600 mm a 1400 mm <i>600 mm to 1400 mm 23¾" to 55½"</i>
	H-KTM	Kit tendina manuale con vetro isolante per porta scorrevole e battente. NOTA: Il movimento delle lamelle è esclusivamente basculante. <i>Manual curtain with insulating glass kit for sliding door. NOTE: The movement of the slats is exclusively tilting.</i>	da 800 a 1400 mm per anta <i>800 to 1400 mm (31½" to 55½") for each leaf</i>
 	H-KTEB1	Kit tendina elettrica con vetro isolante 1 anta battente <i>Electric curtain kit with insulating glass 1 swing leaf</i>	da 600 a 1200 mm <i>600 to 1200 mm 23¾" to 47¼"</i>
	H-KTEB2	Kit tendina elettrica con vetro isolante 2 ante battenti <i>Electric curtain kit with insulating glass 2 swing leaves</i>	da 800 a 1400 mm per anta <i>800 to 1400 mm (31½" to 55½") for each leaf</i>

IMPORTANTE: La tendina è abbinata a un vetro isolante. Tale vetro è incluso nel prezzo indicato
IMPORTANT: The curtain is combined with an insulating glass. This glass is included in the indicated price.

	H-PULSTE	Pulsantiera per comando tendine in acciaio INOX <i>Stainless steel button panel to control the curtains</i>
---	----------	--

Imbotti per porte scorrevoli
Wall frames for sliding doors

			
H-IM155A	Imbotte in alluminio per porte scorrevoli in ALLUMINIO <i>Aluminium wall frame for ALUMINIUM sliding doors</i>	ARGENTO <i>SILVER</i>	da 85 a 155 mm <i>85 up to 155 mm (3 3/8" up to 6 1/8")</i>
H-IM155I	Imbotte in alluminio per porte scorrevoli in ALLUMINIO <i>Aluminium wall frame for ALUMINIUM sliding doors</i>	INOX <i>ST. STEEL</i>	da 85 a 155 mm <i>85 up to 155 mm (3 3/8" up to 6 1/8")</i>
H-IM155R	Imbotte in alluminio per porte scorrevoli in ALLUMINIO <i>Aluminium wall frame for ALUMINIUM sliding doors</i>	RAL	da 85 a 155 mm <i>85 up to 155 mm (3 3/8" up to 6 1/8")</i>
H-IM300A	Imbotte in alluminio per porte scorrevoli in ALLUMINIO <i>Aluminium wall frame for ALUMINIUM sliding doors</i>	ARGENTO <i>SILVER</i>	fino a 300 mm <i>up to 300 mm (11 13/16")</i>
H-IM300I	Imbotte in alluminio per porte scorrevoli in ALLUMINIO <i>Aluminium wall frame for ALUMINIUM sliding doors</i>	INOX <i>ST. STEEL</i>	fino a 300 mm <i>up to 300 mm (11 13/16")</i>
H-IM300R	Imbotte in alluminio per porte scorrevoli in ALLUMINIO <i>Aluminium wall frame for ALUMINIUM sliding doors</i>	RAL	fino a 300 mm <i>up to 300 mm (11 13/16")</i>

NOTA: Sono disponibili su richiesta imbotti per muro con spessore superiore a 300 mm (H-IMBFS A/R/I).

NOTE: Wall frames with thickness over 300 mm - 11 13/16" (H-IMBFS A/R/I) are available on request.

ALLUMINIO / ALUMINIUM

H-IM155A, H-IM155I, H-IM155R



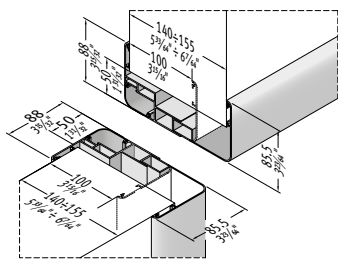

Spessore muro da 85 a 155 mm / Wall thickness 85 to 155 mm - 3 3/8" to 11 13/16"

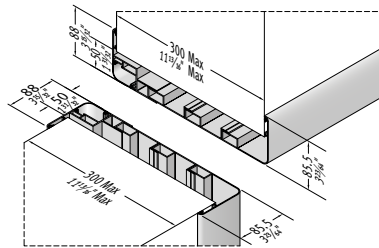

H-IM300A, H-IM300I, H-IM300R

Spessore muro fino a 300 mm / Wall thickness up to 300 mm - 11 13/16"



			
H-IMB101	Imbotte in INOX per scorrevole LV <i>ST. STEEL wall frame for sliding door with LV</i>	da 700 mm a 1000 mm <i>between 700 mm and 1000 mm (27 1/16" and 39 3/8")</i>	da 85 a 155 mm <i>85 up to 155 mm (3 3/8" up to 6 1/8")</i>
H-IMB102	Imbotte in INOX per scorrevole LV <i>ST. STEEL wall frame for sliding door with LV</i>	da 1001 mm a 1400 mm <i>between 1001 mm and 1400 mm (39 3/16" and 55 1/8")</i>	da 85 a 155 mm <i>85 up to 155 mm (3 3/8" up to 6 1/8")</i>
H-IMB103	Imbotte in INOX per scorrevole LV <i>ST. STEEL wall frame for sliding door with LV</i>	da 700 mm a 1000 mm <i>between 700 mm and 1000 mm (27 1/16" and 39 3/8")</i>	fino a 300 mm <i>up to 300 mm (11 13/16")</i>
H-IMB104	Imbotte in INOX per scorrevole LV <i>ST. STEEL wall frame for sliding door with LV</i>	da 1001 mm a 1400 mm <i>between 1001 mm and 1400 mm (39 3/16" and 55 1/8")</i>	fino a 300 mm <i>up to 300 mm (11 13/16")</i>
H-IMB105	Imbotte in INOX per scorrevole LV <i>ST. STEEL wall frame for sliding door with LV</i>	da 1401 mm a 2000 mm <i>between 1401 mm and 2000 mm (55 3/16" and 78 3/4")</i>	da 85 a 155 mm <i>85 up to 155 mm (3 3/8" up to 6 1/8")</i>
H-IMB106	Imbotte in INOX per scorrevole LV <i>ST. STEEL wall frame for sliding door with LV</i>	da 1401 mm a 2000 mm <i>between 1401 mm and 2000 mm (55 3/16" and 78 3/4")</i>	fino a 300 mm <i>up to 300 mm (11 13/16")</i>

NOTA: Sono disponibili su richiesta imbotti per muro con spessore superiore a 300 mm (H-IMBFS A).

NOTE: Wall frames with thickness over 300 mm - 11 13/16" (H-IMBFS A) are available on request.

INOX / ST. STEEL

H-IMB101, H-IMB102, H-IMB105

Spessore muro da 85 a 155 mm / Wall thickness 85 to 155 mm - 3 3/8" to 11 13/16"

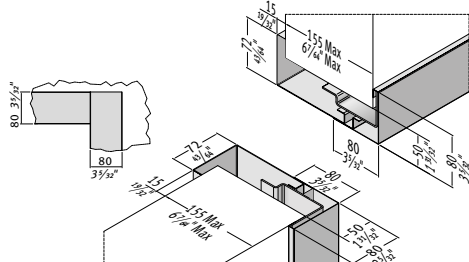

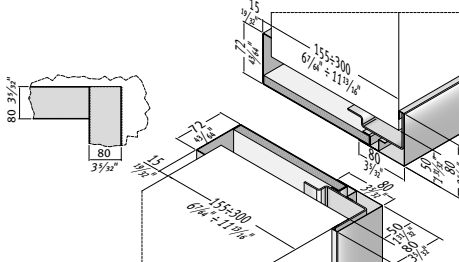

H-IMB103, H-IMB104, H-IMB106

Spessore muro fino a 300 mm / Wall thickness up to 300 mm - 11 13/16"



Semi-imbotti per porte scorrevoli
Semi-wall frames for sliding doors

		
H-SIM100	Semi imbotte scorrevole <i>Semi-wall frame for sliding door</i>	INOX ST. STEEL
H-SIMA	Semi imbotte in ALLUMINIO per porta scorrevole <i>Semi-wall frame in ALUMINIUM for sliding door</i>	ALLUMINIO ALUMINIUM
H-SIMI	Semi imbotte in ALLUMINIO per porta scorrevole <i>Semi-wall frame in ALUMINIUM for sliding door</i>	INOX ST. STEEL
H-SIMR	Semi imbotte in ALLUMINIO per porta scorrevole <i>Semi-wall frame in ALUMINIUM for sliding door</i>	RAL

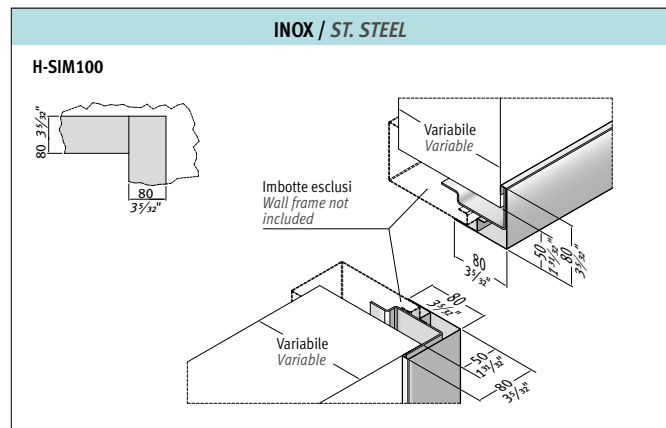
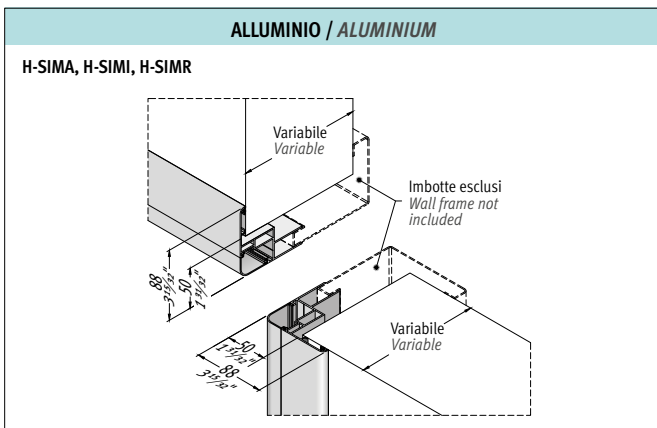

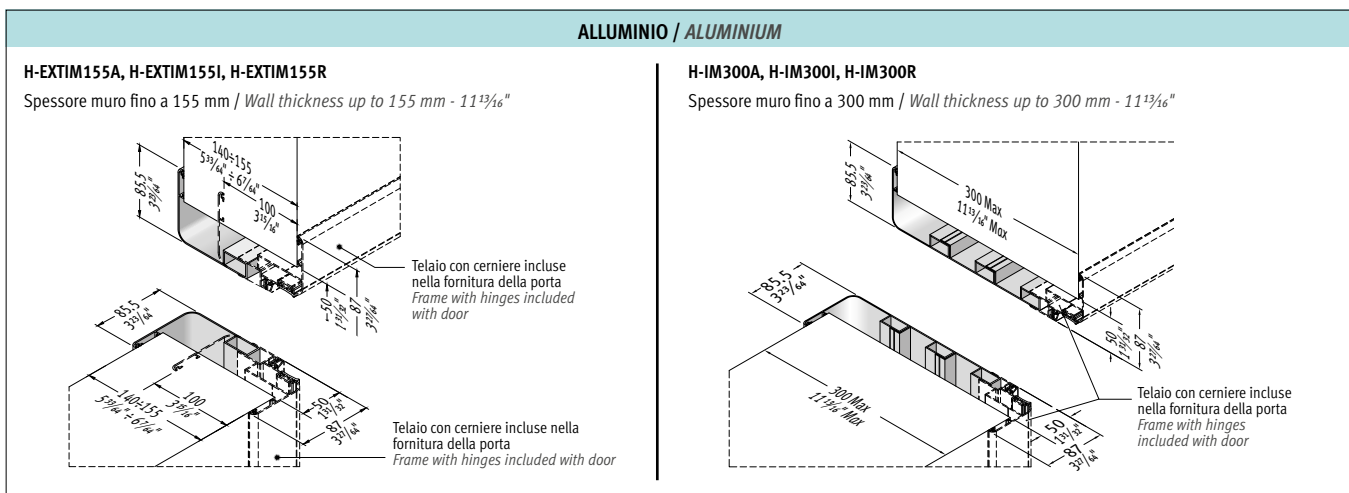

Estensioni per imbotti per porte a battente
Extensions for wall frames for swing doors

			
H-EXTIM155A	Estensione per Imbotte battente in ALLUMINIO <i>Extension for wall frame for swing door in ALUMINIUM</i>	ARGENTO SILVER	da 85 a 155 mm <i>85 up to 155 mm (3 3/8" up to 6 1/8")</i>
H-EXTIM155I	Estensione per Imbotte battente in ALLUMINIO <i>Extension for wall frame for swing doors in ALUMINIUM</i>	INOX ST. STEEL	da 85 a 155 mm <i>85 up to 155 mm (3 3/8" up to 6 1/8")</i>
H-EXTIM155R	Estensione per Imbotte battente in ALLUMINIO <i>Extension for wall frame for swing doors in ALUMINIUM</i>	RAL	da 85 a 155 mm <i>85 up to 155 mm (3 3/8" up to 6 1/8")</i>
H-EXTIM300A	Estensione per Imbotte battente in ALLUMINIO <i>Extension for wall frame for swing door in ALUMINIUM</i>	ARGENTO SILVER	fino a 300 mm <i>up to 300 mm (11 13/16")</i>
H-EXTIM300I	Estensione per Imbotte battente in ALLUMINIO <i>Extension for wall frame for swing doors in ALUMINIUM</i>	INOX ST. STEEL	fino a 300 mm <i>up to 300 mm (11 13/16")</i>
H-EXTIM300R	Estensione per Imbotte battente in ALLUMINIO <i>Extension for wall frame for swing doors in ALUMINIUM</i>	RAL	fino a 300 mm <i>up to 300 mm (11 13/16")</i>



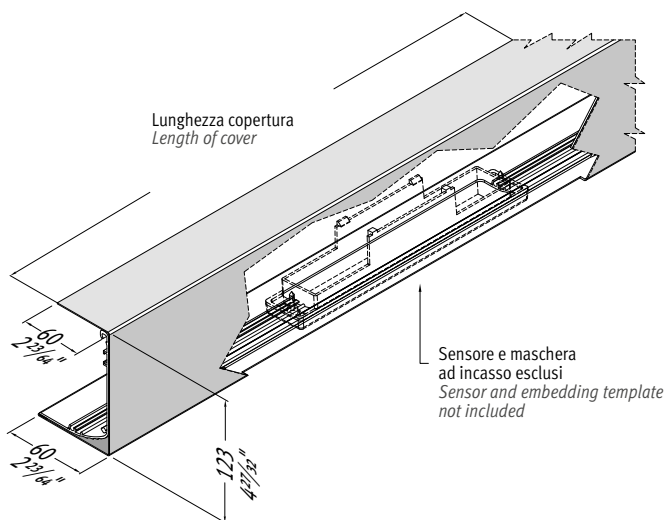

Rivestimenti inox per copertura porte scorrevoli a tenuta semplice
Stainless steel cladding for claddings for simple sealing sliding doors

		
H-GC2000IS	GRUPPO COPERTURA CON RIVESTIMENTO INOX. Tenuta semplice con predisposizione per sensore a incasso. <i>CLADDING UNIT WITH ST. STEEL COATING.</i> <i>Simple seal designed for installation of an embedded sensor.</i>	2000 mm 78 ³ / ₄ "
H-GC2500IS	GRUPPO COPERTURA CON RIVESTIMENTO INOX. Tenuta semplice con predisposizione per sensore a incasso. <i>CLADDING UNIT WITH ST. STEEL COATING.</i> <i>Simple seal designed for installation of an embedded sensor.</i>	2500 mm 98 ⁷ / ₁₆ "
H-GC3000IS	GRUPPO COPERTURA CON RIVESTIMENTO INOX. Tenuta semplice con predisposizione per sensore a incasso. <i>CLADDING UNIT WITH ST. STEEL COATING.</i> <i>Simple seal designed for installation of an embedded sensor.</i>	3000 mm 118 ¹ / ₈ "
H-GC3500IS	GRUPPO COPERTURA CON RIVESTIMENTO INOX. Tenuta semplice con predisposizione per sensore a incasso. <i>CLADDING UNIT WITH ST. STEEL COATING.</i> <i>Simple seal designed for installation of an embedded sensor.</i>	3500 mm 137 ¹³ / ₁₆ "
H-GC4000IS	GRUPPO COPERTURA CON RIVESTIMENTO INOX. Tenuta semplice con predisposizione per sensore a incasso. <i>CLADDING UNIT WITH ST. STEEL COATING.</i> <i>Simple seal designed for installation of an embedded sensor.</i>	4000 mm 157 ¹ / ₂ "
H-GC4500IS	GRUPPO COPERTURA CON RIVESTIMENTO INOX. Tenuta semplice con predisposizione per sensore a incasso. <i>CLADDING UNIT WITH ST. STEEL COATING.</i> <i>Simple seal designed for installation of an embedded sensor.</i>	4500 mm 177 ³ / ₁₆ "



Rivestimenti inox per copertura porte scorrevoli a tenuta ermetica
Stainless steel cladding for hermetically sealing sliding door covers

		
H-GC25IS	GRUPPO COPERTURA CON RIVESTIMENTO INOX. Tenuta ermetica con predisposizione per sensore a incasso. <i>CLADDING UNIT WITH ST. STEEL COATING.</i> <i>Hermetic seal designed for installation of an embedded sensor.</i>	2500 mm 98 ⁷ / ₁₆ "
H-GC31IS	GRUPPO COPERTURA CON RIVESTIMENTO INOX. Tenuta ermetica con predisposizione per sensore a incasso. <i>CLADDING UNIT WITH ST. STEEL COATING.</i> <i>Hermetic seal designed for installation of an embedded sensor.</i>	3100 mm 122 ¹ / ₁₆ "
H-GC37IS	GRUPPO COPERTURA CON RIVESTIMENTO INOX. Tenuta ermetica con predisposizione per sensore a incasso. <i>CLADDING UNIT WITH ST. STEEL COATING.</i> <i>Hermetic seal designed for installation of an embedded sensor.</i>	3700 mm 145 ¹¹ / ₁₆ "
H-GC43IS	GRUPPO COPERTURA CON RIVESTIMENTO INOX. Tenuta ermetica con predisposizione per sensore a incasso. <i>CLADDING UNIT WITH ST. STEEL COATING.</i> <i>Hermetic seal designed for installation of an embedded sensor.</i>	4300 mm 169 ⁹ / ₁₆ "

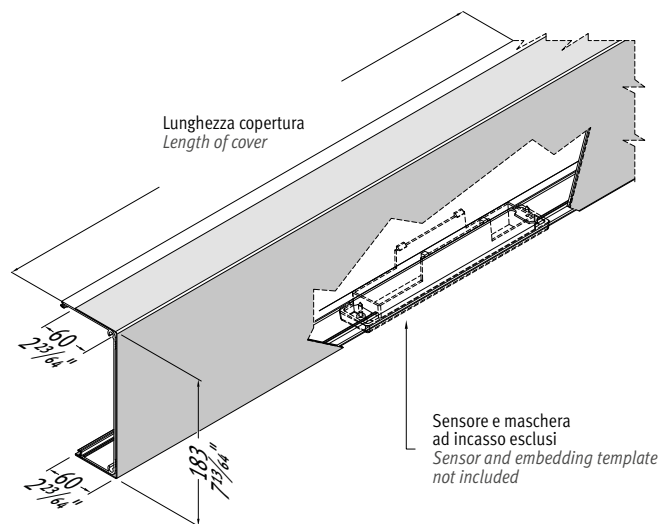

Fasce
Bands

			
	H-FASC4A	FASCIA ALLUMINIO OSSIDATO ARGENTO <i>ALUMINIUM BAND OXIDIZED-SILVER</i>	fino a 200x2000 mm (A COPPIA) <i>up to 200x2000 mm (7⁷/₈" x 78³/₄")</i> (PER PAIR)
	H-FASC4I	FASCIA INOX/LAMIERA ZINCATA E VERNICIATA <i>BAND IN STAINLESS STEEL/GALVANIZED AND PAINTED PLATE</i>	fino a 200x2000 mm (A COPPIA) <i>up to 200x2000 mm (7⁷/₈" x 78³/₄")</i> (PER PAIR)
	H-FASC4R	FASCIA ALLUMINIO VERNICIATO RAL <i>ALUMINIUM BAND RAL PAINTED</i>	fino a 200x2000 mm (A COPPIA) <i>up to 200x2000 mm (7⁷/₈" x 78³/₄")</i> (PER PAIR)



Le porte LABEL Hospital rivestite con pannelli in acciaio inox o in laminato, possono essere fornite anche con lastre di piombo di spessore da 1, 2, 3 o 4 mm per la protezione dai raggi X. La realizzazione di alcuni modelli è vincolata essenzialmente al peso che la porta può raggiungere a fronte dell'inserimento della lastra di piombo al suo interno.

Consultare l'Ufficio Tecnico LABEL per avere conferma sulla fattibilità di tale installazione sulla vostra porta.

NOTA: Il peso del piombo è 12 kg/mq per millimetro di spessore.



The LABEL Hospital doors with stainless steel or HPL panels, can also be provided with lead plates with thickness of 1, 2, 3 (1/16", 1/8" or 4 mm (3/16")) for protection from X-rays. The feasibility of some models depends on the weight of the door after a lead plate has been added.

Refer to the LABEL technical service about the feasibility of such installation on your door.

NOTE: The weight of lead is 12 kg (26lb)/sqm per millimeter of thickness.

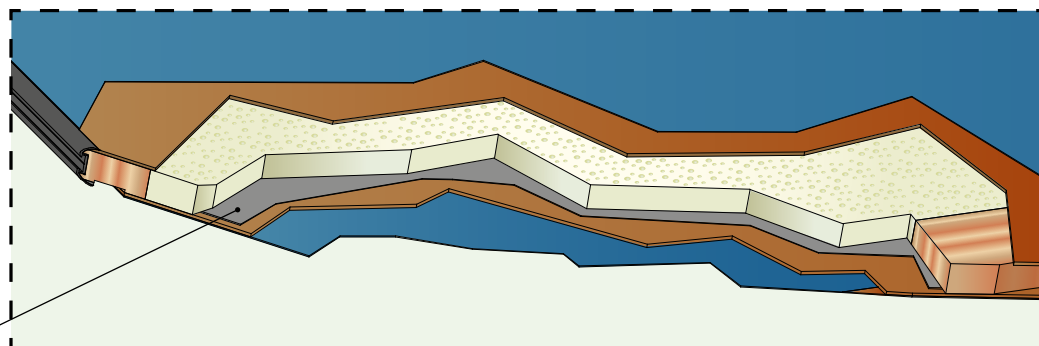
Lastra di piombo (opzionale)
Lead plate (optional)



		
H-PB1-800	Schermatura con lastra di Piombo (1 mm) Shielding with 1 mm (1/16") lead plate	per porta 800x2150 mm for a door 800x2150 mm (31 1/2" x 84 5/8")
H-PB1-900	Schermatura con lastra di Piombo (1 mm) Shielding with 1 mm (1/16") lead plate	per porta 900x2150 mm for a door 900x2150 mm (35 7/16" x 84 5/8")
H-PB1-1000	Schermatura con lastra di Piombo (1 mm) Shielding with 1 mm (1/16") lead plate	per porta 1000x2150 mm for a door 1000x2150 mm (39 3/8" x 84 5/8")
H-PB1-1100	Schermatura con lastra di Piombo (1 mm) Shielding with 1 mm (1/16") lead plate	per porta 1100x2150 mm for a door 1100x2150 mm (43 1/16" x 84 5/8")
H-PB1-1200	Schermatura con lastra di Piombo (1 mm) Shielding with 1 mm (1/16") lead plate	per porta 1200x2150 mm for a door 1200x2150 mm (47 1/4" x 84 5/8")
H-PB1-1300	Schermatura con lastra di Piombo (1 mm) Shielding with 1 mm (1/16") lead plate	per porta 1300x2150 mm for a door 1300x2150 mm (51 3/16" x 84 5/8")
H-PB1-1400	Schermatura con lastra di Piombo (1 mm) Shielding with 1 mm (1/16") lead plate	per porta 1400x2150 mm for a door 1400x2150 mm (55 3/8" x 84 5/8")
H-PB1-1500	Schermatura con lastra di Piombo (1 mm) Shielding with 1 mm (1/16") lead plate	per porta 1500x2150 mm for a door 1500x2150 mm (59 1/16" x 84 5/8")
H-PB1-1600	Schermatura con lastra di Piombo (1 mm) Shielding with 1 mm (1/16") lead plate	per porta 1600x2150 mm for a door 1600x2150 mm (63" x 84 5/8")
H-PB1-1700	Schermatura con lastra di Piombo (1 mm) Shielding with 1 mm (1/16") lead plate	per porta 1700x2150 mm for a door 1700x2150 mm (66 15/16" x 84 5/8")
H-PB1-1800 ^	Schermatura con lastra di Piombo (1 mm) Shielding with 1 mm (1/16") lead plate	per porta 1800x2150 mm for a door 1800x2150 mm (70 7/8" x 84 5/8")
H-PB1-1900 ^	Schermatura con lastra di Piombo (1 mm) Shielding with 1 mm (1/16") lead plate	per porta 1900x2150 mm for a door 1900x2150 mm (74 13/16" x 84 5/8")
H-PB1-2000 ^	Schermatura con lastra di Piombo (1 mm) Shielding with 1 mm (1/16") lead plate	per porta 2000x2150 mm for a door 2000x2150 mm (78 3/4" x 84 5/8")



^ = Per l'installazione di queste schermature sui modelli HB-SAITE e HB-SALTE, rivolgersi all'Ufficio Tecnico LABEL per conferme sulla fattibilità.

^ = For the feasibility of the installation of these shields on the models HB-SAITE and HB-SALTE, refer to the LABEL Technical Service.

IMPORTANTE: La lastra di piombo è presente solo nel pannello. L'imbotte o l'estensione imbotte (se previste nella fornitura) non sono MAI dotate di lastra di piombo. Schermatura del muro/parete non di competenza LABEL.

IMPORTANT: The lead plate is only present in the panel. The wall frame or wall frame extension (if provided for in the supply) is NEVER equipped with a lead plate. Wall protection not in LABEL scope.



		
H-PB2-800	Schermatura con lastra di Piombo (2 mm) <i>Shielding with 2 mm (1/16") lead plate</i>	per porta 800x2150 mm <i>for a door 800x2150 mm (31 1/2" x 84 5/8")</i>
H-PB2-900	Schermatura con lastra di Piombo (2 mm) <i>Shielding with 2 mm (1/16") lead plate</i>	per porta 900x2150 mm <i>for a door 900x2150 mm (35 3/8" x 84 5/8")</i>
H-PB2-1000	Schermatura con lastra di Piombo (2 mm) <i>Shielding with 2 mm (1/16") lead plate</i>	per porta 1000x2150 mm <i>for a door 1000x2150 mm (39 3/8" x 84 5/8")</i>
H-PB2-1100	Schermatura con lastra di Piombo (2 mm) <i>Shielding with 2 mm (1/16") lead plate</i>	per porta 1100x2150 mm <i>for a door 1100x2150 mm (43 3/8" x 84 5/8")</i>
H-PB2-1200	Schermatura con lastra di Piombo (2 mm) <i>Shielding with 2 mm (1/16") lead plate</i>	per porta 1200x2150 mm <i>for a door 1200x2150 mm (47 3/4" x 84 5/8")</i>
H-PB2-1300	Schermatura con lastra di Piombo (2 mm) <i>Shielding with 2 mm (1/16") lead plate</i>	per porta 1300x2150 mm <i>for a door 1300x2150 mm (51 3/8" x 84 5/8")</i>
H-PB2-1400	Schermatura con lastra di Piombo (2 mm) <i>Shielding with 2 mm (1/16") lead plate</i>	per porta 1400x2150 mm <i>for a door 1400x2150 mm (55 1/2" x 84 5/8")</i>
H-PB2-1500	Schermatura con lastra di Piombo (2 mm) <i>Shielding with 2 mm (1/16") lead plate</i>	per porta 1500x2150 mm <i>for a door 1500x2150 mm (59 1/8" x 84 5/8")</i>
H-PB2-1600 ^	Schermatura con lastra di Piombo (2 mm) <i>Shielding with 2 mm (1/16") lead plate</i>	per porta 1600x2150 mm <i>for a door 1600x2150 mm (63" x 84 5/8")</i>
H-PB2-1700 ^	Schermatura con lastra di Piombo (2 mm) <i>Shielding with 2 mm (1/16") lead plate</i>	per porta 1700x2150 mm <i>for a door 1700x2150 mm (66 13/16" x 84 5/8")</i>
H-PB2-1800 ^ *	Schermatura con lastra di Piombo (2 mm) <i>Shielding with 2 mm (1/16") lead plate</i>	per porta 1800x2150 mm <i>for a door 1800x2150 mm (70 7/8" x 84 5/8")</i>
H-PB2-1900 ^ *	Schermatura con lastra di Piombo (2 mm) <i>Shielding with 2 mm (1/16") lead plate</i>	per porta 1900x2150 mm <i>for a door 1900x2150 mm (74 13/16" x 84 5/8")</i>
H-PB2-2000 ^ *	Schermatura con lastra di Piombo (2 mm) <i>Shielding with 2 mm (1/16") lead plate</i>	per porta 2000x2150 mm <i>for a door 2000x2150 mm (78 3/4" x 84 5/8")</i>

^ = Per l'installazione di queste schermature sui modelli HB-SAITTE e HB-SALTE e porte a battente, rivolgersi all'Ufficio Tecnico LABEL per conferme sulla fattibilità.

^ = For the feasibility of the installation of these shields on the models HB-SAITTE and HB-SALTE and swing doors, refer to the LABEL Technical Service.



* = Prodotto fornibile solo nelle versioni di porte a tenuta semplice

* = Product available only in simple sealing version

IMPORTANTE: La lastra di piombo è presente solo nel pannello. L'imbotte o l'estensione imbotte (se previste nella fornitura) non sono MAI dotate di lastra di piombo. Schermatura del muro/parete non di competenza LABEL.

IMPORTANT: The lead plate is only present in the panel. The wall frame or wall frame extension (if provided for in the supply) is NEVER equipped with a lead plate. Wall protection not in LABEL scope.



		
H-PB3-800	Schermatura con lastra di piombo 3 mm <i>Shielding with 3 mm (1/8") lead plate</i>	per porta 800x2150 mm <i>for a door 800x2150 mm (31 1/2" x 84 5/8")</i>
H-PB3-900	Schermatura con lastra di piombo 3 mm <i>Shielding with 3 mm (1/8") lead plate</i>	per porta 900x2150 mm <i>for a door 900x2150 mm (35 3/8" x 84 5/8")</i>
H-PB3-1000	Schermatura con lastra di piombo 3 mm <i>Shielding with 3 mm (1/8") lead plate</i>	per porta 1000x2150 mm <i>for a door 1000x2150 mm (39 3/8" x 84 5/8")</i>
H-PB3-1100	Schermatura con lastra di piombo 3 mm <i>Shielding with 3 mm (1/8") lead plate</i>	per porta 1100x2150 mm <i>for a door 1100x2150 mm (43 3/8" x 84 5/8")</i>
H-PB3-1200	Schermatura con lastra di piombo 3 mm <i>Shielding with 3 mm (1/8") lead plate</i>	per porta 1200x2150 mm <i>for a door 1200x2150 mm (47 1/4" x 84 5/8")</i>
H-PB3-1300	Schermatura con lastra di piombo 3 mm <i>Shielding with 3 mm (1/8") lead plate</i>	per porta 1300x2150 mm <i>for a door 1300x2150 mm (51 3/8" x 84 5/8")</i>
H-PB3-1400	Schermatura con lastra di piombo 3 mm <i>Shielding with 3 mm (1/8") lead plate</i>	per porta 1400x2150 mm <i>for a door 1400x2150 mm (55 1/8" x 84 5/8")</i>
H-PB3-1500	Schermatura con lastra di piombo 3 mm <i>Shielding with 3 mm (1/8") lead plate</i>	per porta 1500x2150 mm <i>for a door 1500x2150 mm (59 1/8" x 84 5/8")</i>
H-PB3-1600	Schermatura con lastra di piombo 3 mm <i>Shielding with 3 mm (1/8") lead plate</i>	per porta 1600x2150 mm <i>for a door 1600x2150 mm (63" x 84 5/8")</i>
H-PB3-1700	Schermatura con lastra di piombo 3 mm <i>Shielding with 3 mm (1/8") lead plate</i>	per porta 1700x2150 mm <i>for a door 1700x2150 mm (66 13/16" x 84 5/8")</i>
H-PB3-1800	Schermatura con lastra di piombo 3 mm <i>Shielding with 3 mm (1/8") lead plate</i>	per porta 1800x2150 mm <i>for a door 1800x2150 mm (70 7/8" x 84 5/8")</i>
H-PB3-1900	Schermatura con lastra di piombo 3 mm <i>Shielding with 3 mm (1/8") lead plate</i>	per porta 1900x2150 mm <i>for a door 1900x2150 mm (74 13/16" x 84 5/8")</i>
H-PB3-2000	Schermatura con lastra di piombo 3 mm <i>Shielding with 3 mm (1/8") lead plate</i>	per porta 2000x2150 mm <i>for a door 2000x2150 mm (78 3/4" x 84 5/8")</i>



NOTA: È possibile installare lastre in Piombo di 3 mm su tutti i modelli di porte scorrevoli HOSPITAL.
È necessario rivolgersi all'Ufficio Tecnico LABEL per conferme sulla fattibilità di installazione.

NOTE: It is possible to install 3 mm (1/8") lead plates on all the models of HOSPITAL sliding doors.
Please, contact LABEL Technical Department about the feasibility of the installation.

IMPORTANTE: La lastra di piombo è presente solo nel pannello. L'imbotte o l'estensione imbotte (se previste nella fornitura) non sono MAI dotate di lastra di piombo. Schermatura del muro/parete non di competenza LABEL.

IMPORTANT: The lead plate is only present in the panel. The wall frame or wall frame extension (if provided for in the supply) is NEVER equipped with a lead plate. Wall protection not in LABEL scope.















		
H-PB4-800	Schermatura con lastra di piombo 4 mm <i>Shielding with 4 mm (3/16") lead plate</i>	per porta 800x2150 mm <i>for a door 800x2150 mm (31 1/2" x 84 5/8")</i>
H-PB4-900	Schermatura con lastra di piombo 4 mm <i>Shielding with 4 mm (3/16") lead plate</i>	per porta 900x2150 mm <i>for a door 900x2150 mm (35 3/16" x 84 5/8")</i>
H-PB4-1000	Schermatura con lastra di piombo 4 mm <i>Shielding with 4 mm (3/16") lead plate</i>	per porta 1000x2150 mm <i>for a door 1000x2150 mm (39 3/8" x 84 5/8")</i>
H-PB4-1100	Schermatura con lastra di piombo 4 mm <i>Shielding with 4 mm (3/16") lead plate</i>	per porta 1100x2150 mm <i>for a door 1100x2150 mm (43 3/16" x 84 5/8")</i>
H-PB4-1200	Schermatura con lastra di piombo 4 mm <i>Shielding with 4 mm (3/16") lead plate</i>	per porta 1200x2150 mm <i>for a door 1200x2150 mm (47 1/4" x 84 5/8")</i>
H-PB4-1300	Schermatura con lastra di piombo 4 mm <i>Shielding with 4 mm (3/16") lead plate</i>	per porta 1300x2150 mm <i>for a door 1300x2150 mm (51 3/16" x 84 5/8")</i>
H-PB4-1400	Schermatura con lastra di piombo 4 mm <i>Shielding with 4 mm (3/16") lead plate</i>	per porta 1400x2150 mm <i>for a door 1400x2150 mm (55 1/8" x 84 5/8")</i>
H-PB4-1500	Schermatura con lastra di piombo 4 mm <i>Shielding with 4 mm (3/16") lead plate</i>	per porta 1500x2150 mm <i>for a door 1500x2150 mm (59 1/16" x 84 5/8")</i>
H-PB4-1600	Schermatura con lastra di piombo 4 mm <i>Shielding with 4 mm (3/16") lead plate</i>	per porta 1600x2150 mm <i>for a door 1600x2150 mm (63" x 84 5/8")</i>
H-PB4-1700	Schermatura con lastra di piombo 4 mm <i>Shielding with 4 mm (3/16") lead plate</i>	per porta 1700x2150 mm <i>for a door 1700x2150 mm (66 13/16" x 84 5/8")</i>
H-PB4-1800	Schermatura con lastra di piombo 4 mm <i>Shielding with 4 mm (3/16") lead plate</i>	per porta 1800x2150 mm <i>for a door 1800x2150 mm (70 7/8" x 84 5/8")</i>
H-PB4-1900	Schermatura con lastra di piombo 4 mm <i>Shielding with 4 mm (3/16") lead plate</i>	per porta 1900x2150 mm <i>for a door 1900x2150 mm (74 13/16" x 84 5/8")</i>
H-PB4-2000	Schermatura con lastra di piombo 4 mm <i>Shielding with 4 mm (3/16") lead plate</i>	per porta 2000x2150 mm <i>for a door 2000x2150 mm (78 3/4" x 84 5/8")</i>

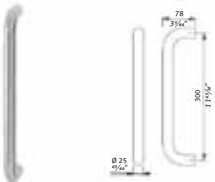
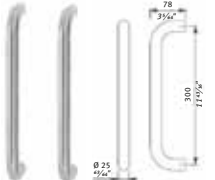







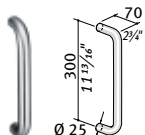
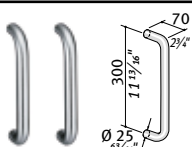





NOTA: È possibile installare lastre in Piombo di 4 mm su tutti i modelli di porte scorrevoli HOSPITAL.
È necessario rivolgersi all'Ufficio Tecnico LABEL per conferme sulla fattibilità di installazione.

NOTE: It is possible to install 4 mm (3/16") lead plates on all the models of HOSPITAL sliding doors.
Please, contact LABEL Technical Department about the feasibility of the installation.

IMPORTANTE: La lastra di piombo è presente solo nel pannello. L'imbotte o l'estensione imbotte (se previste nella fornitura) non sono MAI dotate di lastra di piombo. Schermatura del muro/parete non di competenza LABEL.

IMPORTANT: The lead plate is only present in the panel. The wall frame or wall frame extension (if provided for in the supply) is NEVER equipped with a lead plate. Wall protection not in LABEL scope.

MANIGLIE HANDLES				
	H-MAND1-AB	Maniglione diritto SINGOLO in acciaio inox trattamento antibatterico <i>SINGLE straight pull handle in stainless steel Antibacterial Treatment</i>		•
	H-MAND2-AB	Maniglione diritto DOPPIO in acciaio inox trattamento antibatterico <i>DOUBLE straight pull handle in stainless steel Antibacterial Treatment</i>		•
	H-MANDSV1-AB	Maniglione diritto SINGOLO in acciaio inox trattamento antibatterico vetrate scorrevoli singola anta (incluso profilo maggiorato) <i>SINGLE straight pull handle in stainless steel Antibacterial Treatment (including increased profile)</i>		•
	H-MANISV1	Maniglia ad incasso in inox per porta scorrevole vetrata (incluso profilo maggiorato) <i>Recessed handle in stainless steel for glazed sliding door (including oversized profiles)</i>		•
	H-MANOSV1	Maniglia ad incasso Ovale in Alluminio Satinato per porta scorrevole vetrata (incluso profilo maggiorato) <i>Recessed Oval handle in Aluminum Satin Finish for glazed sliding door (including oversized profiles)</i>		•
	H-MANA	Maniglia alzante in acciaio inox per porta scorrevole ERMETICA <i>Stainless steel lifting handle for HERMETICALLY sealing sliding door</i>		•
	MPH9102	Piastrina di riscontro per maniglia H-MANA (per la soluzione in acciaio inox) <i>Strike plate for H-MANA handle (for the solution in stainless steel)</i>		•
	H-MANI	Maniglia ad incasso in inox (confezione singola) <i>Recessed handle in stainless steel (one per package)</i>		•
	H-MANO	Maniglia ad incasso ovale (confezione singola) <i>Recessed oval handle (one per package)</i>		•
	H-MAND1	Maniglione diritto SINGOLO in acciaio inox AISI 316 <i>SINGLE straight pull handle in AISI 316 stainless steel</i>		•
	H-MAND2	Maniglione diritto DOPPIO in acciaio inox AISI 316 <i>DOUBLE straight pull handle in AISI 316 stainless steel</i>		•

MANIGLIE HANDLES		 	 H-BML / H-BMI	 H-BMV
	H-MAN0011-AB	Maniglia a leva INOX trattamento antibatterico B/R Tonde <i>Lever Handle in Stainless Steel Round rose antibacterial treatment</i>	•	
	H-MAN0021-AB	Maniglia a leva INOX trattamento antibatterico B/R Tonde con Set WC L/O <i>Lever Handle in Stainless Steel with bathroom turn and indicator set on Round escutcheon, antibacterial treatment</i>	•	
	H-MAN001	Maniglia a leva Alluminio Satinato B/R Tonde <i>Lever handle in Aluminum Satin Finish Round rose</i>	•	
	H-MAN002	Maniglia a leva Alluminio Satinato B/R Tonde con Set WC L/O <i>Lever handle in Aluminum Satin Finish with bathroom turn and indicator set on Round escutcheon</i>	•	•
	H-MAN0031-AB	Maniglia a leva INOX trattamento antibatterico B/R Ovale per porte H-BMV <i>Lever handle in stainless steel antibacterial treatment Oval escutcheon/rose for H-BMV doors</i>		•
	H-MAN0041-AB	Maniglia a leva INOX trattamento antibatterico B/R Ovale con Set WC L/O per porte H-BMV <i>Lever handle in stainless steel antibacterial treatment Oval escutcheon/rose with bathroom turn and indicator set for H-BMV doors</i>		•
	H-MAN003	Maniglia a leva Alluminio Satinato B/R Ovale per porte H-BMV <i>Lever handle in aluminium with satin finish Oval escutcheon/rose for H-BMV doors</i>		•
	H-MAN004	Maniglia a leva Alluminio Satinato B/R Ovale con Set WC L/O, per porte H-BMV (*) <i>Lever handle in aluminium with satin finish Oval escutcheon/rose with bathroom turn and indicator set for H-BMV doors (*)</i>		•
	H-MANP1-AB	Pomolo singolo in INOX trattamento antibatterico Ø 50 mm <i>Single knob in Stainless Steel Ø 50 mm (2"), antibacterial treatment</i>	•	•
	H-MANP2-AB	Pomolo doppio in INOX trattamento antibatterico Ø 50 mm <i>Dual knob in Stainless Steel Ø 50 mm (2"), antibacterial treatment</i>	•	•
	H-MANP1	Pomolo singolo in Alluminio Satinato Ø 50 mm (*) <i>Single knob in Aluminum Satin Finish Ø 50 mm - 2" (*)</i>	•	•
	H-MANP2	Pomolo doppio in Alluminio Satinato Ø 50 mm (*) <i>Dual knob in Aluminum Satin Finish Ø 50 mm - 2" (*)</i>	•	•

(*) A richiesta / (*) On request





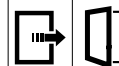



SERRATURE
LOCKS



		H-SERBP1	<p>Serratura per porta a battente manuale (1) e automatica singola anta per soluzione pannello (da abbinare a H-KIEPA se automatica) <i>Lock for manual (1) and automatic single leaf swing door for panel solution (to combine with H-KIEPA if Automatic)</i></p>		•
		H-SERBP2-A	<p>Serrature meccanica per porta a battente completa di catenaccio per seconda anta, valida per doppia anta per soluzioni pannello (da abbinare a H-KIEPA se automatica) <i>Mechanical locks for hinged door complete with deadbolt for second leaf, valid for double leaves panel solution (to combine with H-KIEPA if automatic)</i></p>		•
		H-SERSV1	<p>Serratura per ante mobili con chiusura centrale, valida per singola anta HB-SAVTS / H-SMVTS <i>Lock for mobile doors with central locking, valid for single HB-SAVTS / H-SMVTS leaf</i></p>		•
		H-SERSV2	<p>Serratura per ante scorrevoli con chiusura centrale, valida per anta doppia HB-SAVTS / H-SMVTS <i>Lock for sliding doors with central locking, valid for double leaf HB-SAVTS / H-SMVTS</i></p>		•
		H-SERBV1	<p>Serratura meccanica per porta a battente singola anta automatica per soluzioni vetrate (abbinare a H-KIEVA) <i>Mechanical lock for swing door automatic single leaf for glass solution (to combine with H-KIEVA)</i></p>		•
		H-SERBV2-A	<p>Serratura meccanica per porta a battente completa di catenaccio per seconda anta, valida per doppia anta asimmetrica per soluzioni vetrate (da abbinare a H-KIEVA se Automatica) <i>Mechanical lock for swing door complete with deadbolt for second leaf, valid for double asymmetric leaves glass solution (to combine with H-KIEVA if automatic)</i></p>		•
		H-SERSP1	<p>Serratura per porta scorrevole a gancio, valida per HB-SALTS/ H-SMLTS/HB-SAITS/H-SMITS-1 singola anta <i>Lock for sliding door hook, valid for HB-SALTS / H-SMLTS / HB-SAITS /H-SMITS-1 single leaf</i></p>		•
		H-SERSP2	<p>Serratura per ante mobili doppie con chiusura a gancio per HB-SALTS/H-SMLTS/HB-SAITS <i>Lock for movable double leaf with hook closure for HB-SALTS / H-SMLTS / HB-SAITS</i></p>		•
		H-SERXT1	<p>Serratura per porta a battente Manuale singola anta per soluzione pannello (soluzione Base senza Mandata) <i>Mechanical lock for hinged door Manual single door leaf panel solution (Basic Solution without Bolt)</i></p>		•
		H-SERXT2-A	<p>Serratura meccanica per porta a Manuale battente completa di catenacci per seconda anta, valida per doppia anta asimmetrica per soluzioni pannello (soluzione Base senza Mandata) Mechanical lock for hinged door complete with deadbolts for second leaf, valid for double asymmetric leaves panel solution (Basic Solution without Bolt)</p>		•

(1) la porta a battente manuale nella versione di base è accessoriata con una serratura ad aggancio magnetico diversa dalla dotazione H-SERBP
(1) Manual swing door in the basic version is equipped with a magnetic coupling lock different from the H-SERBP supplied

SERRATURE LOCKS			
	H-KEMPA	Elettromagnete per ante a battente automatiche HB-B75/B150/B300 L-I (per montaggio a incasso) <i>Electromagnet for automatic swing doors HB-B75/B150/B300 L-I (flush mounting)</i>	•
	H-KEMPM	Elettromagnete per ante a battente manuali H-BMI/H-BML completo di alimentatore (per montaggio a incasso) <i>Electromagnet for manual swing doors H-BMI / H-BML complete with power supply (flush mounting)</i>	•
	H-KIEPA	Incontro elettrico per ante a battente automatiche HB-B75/B150/B300 L-I <i>Electric strike for automatic swing doors HB-B75/B150/B300 L-I</i>	•
	H-KIEPMA	Incontro elettrico con alimentatore per ante a battente manuali H-BML/H-BMI con funzione antipanico <i>Electric strike with power supply for manual swing doors H-BML/H-BMI with breakout function</i>	•
	H-KIEPMI	Incontro elettrico con alimentatore per ante a battente manuali H-BML/H-BMI con funzione interblocco <i>Electric strike with power supply for manual swing doors H-BML/H-BMI with interlock function</i>	•
	H-KIEPMS	Incontro elettrico con alimentatore per ante a battente manuali H-BML/H-BMI con funzione stand-alone <i>Electric strike with power supply for manual swing doors H-BML/H-BMI with stand-alone function</i>	•
	H-KIEVA	Incontro elettrico per ante a battente automatiche HB-B75/B150/B300 V <i>Electric strike for HB-B75/B150/B300 V automatic swing doors</i>	•
	H-KIEVMA	Incontro elettrico con alimentatore per ante a battente automatiche H-BMV con funzione antipanico <i>Electric strike with power supply for automatic swing doors H-BMV with breakout function</i>	•
	H-KIEVMI	Incontro elettrico con alimentatore per ante a battente automatiche H-BMV con funzione interblocco <i>Electric strike with power supply for automatic swing doors H-BMV with interlock function</i>	•
	H-KIEVMS	Incontro elettrico con alimentatore per ante a battente automatiche H-BMV con funzione stand-alone <i>Electric strike with power supply for automatic swing doors H-BMV with stand-alone function</i>	•
	V00244	Elettromagnete per porta a battente MONTAGGIO ESTERNO <i>Electromagnet for swing door EXTERNAL ASSEMBLY</i>	•
	V00245	Staffa montaggio a "L" per elettromagnete con copertura <i>"L" mounting bracket for electromagnet with cover</i>	•



SISTEMA INTERBLOCCO

Il sistema interblocco è un metodo di controllo accessi tra due porte automatiche collegate elettronicamente tra di loro, in modo che una si può aprire solo se l'altra è chiusa.

In ambito **ospedaliero, studi medici, strutture farmaceutiche, il sistema interblocco viene impiegato per separare i reparti e le zone di isolamento in modo sicuro e igienico, oltre a impedire l'ingresso alle persone non autorizzate.**

Il principio di funzionamento prevede l'apertura della prima porta quando l'utente attiva il dispositivo di apertura esterno per entrare nell'area interna. La seconda porta si può aprire solo dopo che la prima si è chiusa, attivando il proprio dispositivo di apertura interno.

INTERLOCK SYSTEM

The interlock system is an access control method between two automatic doors electronically connected to each other, so that one can open only if the other is closed.

In a hospital environment, medical consultation rooms, pharmaceutical facilities, the interlock system is used to separate departments and isolation areas safely and hygienically, and to prevent unauthorized persons from entering.

The principle of operation provides for the opening of the first door when the user activates the external opening device to enter the internal area.

The second door can only be opened after the first door is closed, activating its internal opening device.

Interblocco per porte automatiche scorrevoli Interlock for automatic sliding doors

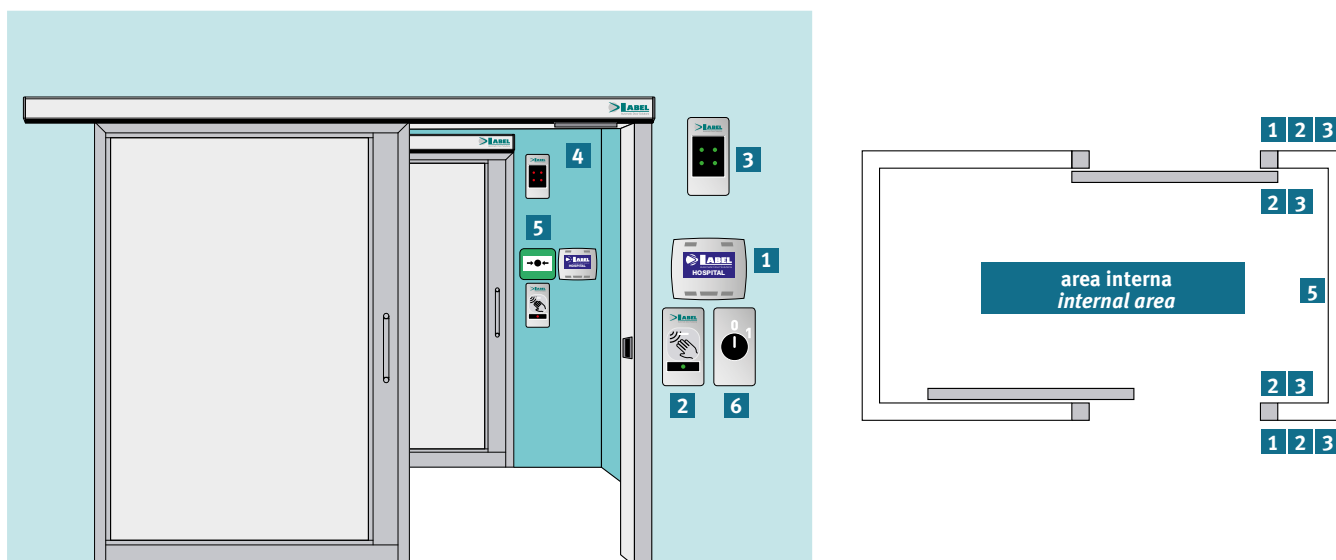

Articoli necessari al funzionamento base del sistema interblocco:

- 1** Programmatore digitale ET-DSEL oppure T-NFC installato su ogni porta ad uso dell'utente.
- 2** Dispositivi di apertura: scegliere tra sensori a sfioramento o pulsanti per permettere l'apertura a tutti gli utenti.
Per consentire l'apertura solo a personale autorizzato scegliere i lettori di badge o le tastiere a codice (consultare la sezione "Sensori e accessori generici").
- 3** Semafori per segnalazione stato porta (art. T-LED oppure cod. V00175); luce verde con porte chiuse su entrambi i semafori, luce rossa sulla porta chiusa in caso di apertura dell'altra.
Per la gestione del semaforo necessario un ulteriore modulo UR24/E per ogni automazione (opzionale).
- 4** Sensori di sicurezza da prevedere.
- 5** Pulsante per l'apertura di emergenza delle porte (consultare la sezione "Accessori generici" pag. 117).
- 6** Selettore ON/OFF di esclusione interblocco, per consentire il funzionamento indipendente delle due porte (art. V00148).

- Modulo UR24/E (cod. V01204) per ogni automazione.

- Elettroblocco di chiusura porta (consultare la sezione "Elettroblocchi" presente in ogni tipologia di automazione opzionale pag. 116)

Items required for basic operation of the interlock system:

- 1** Digital selector ET-DSEL or T-NFC installed on each door.
- 2** Opening devices: choose between touch sensors or buttons to allow all users to open.
To allow only authorized personnel to open, choose badge readers or keypads (see "General Sensors and Accessories").
- 3** Signaling light for door status signaling (item T-LED or code V00175); green light with closed doors on both signaling lights, red light on closed door if the other door is opened.
For signaling light management, an additional module UR24/E is required for each automation (optional).
- 4** Safety sensors to be provided for.
- 5** Emergency door release button (refer to "General Accessories" page 117).
- 6** Interlock override ON/OFF switch, to allow independent operation of the two doors (item V00148).

- UR24/E module (code V01204) for every automation.

- Door locking electric lock (see section "Electric locks" in each type of optional automation page 116).



Interblocco per porte automatiche a battente Interlock for automatic swing doors

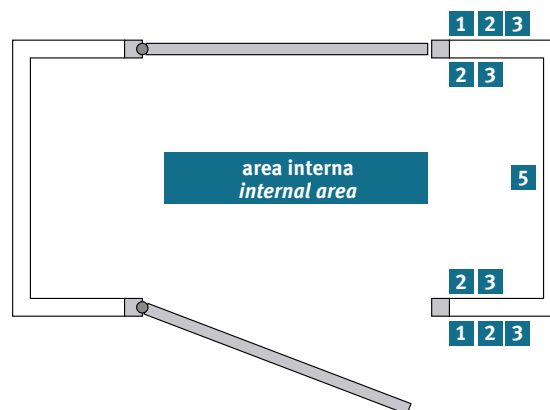
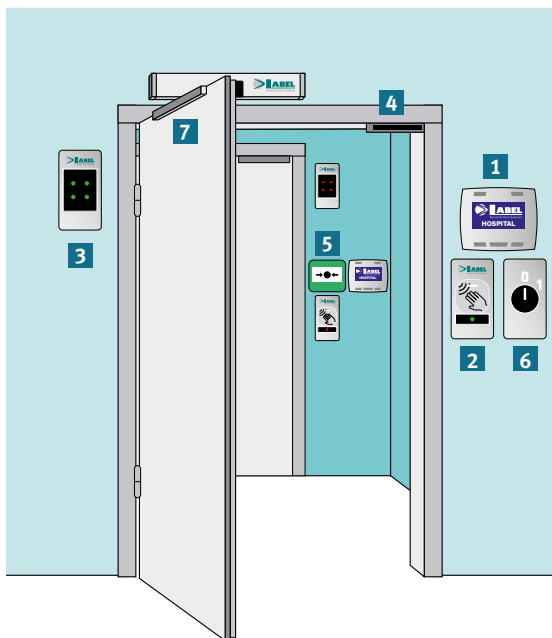

Articoli necessari al funzionamento base del sistema interblocco:

- 1** Programmatore digitale installato su ogni porta ad uso dell'utente: ET-DSEL oppure T-NFC per NEXT e NEPTIS PLUS.
- 2** Dispositivi di apertura: scegliere tra sensori a sfioramento o pulsanti per permettere l'apertura a tutti gli utenti. Scegliere lettori di badge o tastiere a codice per consentire l'apertura solo a personale autorizzato (consultare la sezione "Sensori e accessori generici").
- 3** Semafori per segnalazione stato porta (art. T-LED oppure cod. V00175). Luce verde con porte chiuse su entrambi i semafori, luce rossa sulla porta chiusa in caso di apertura dell'altra.
Per la gestione del semaforo necessario un modulo UR2 per ogni automazione tipo NEXT.
- 4** Elettromagnete di chiusura porta o in alternativa incontri elettrici che richiedono la predisposizione di una serratura con lo scrocco (consultare la pagina "sistemi di chiusura" pag. 111).
- 5** Pulsante per l'apertura di emergenza delle porte (consultare la sezione "Accessori generici" pag. 117).
- 6** Selettore ON/OFF di esclusione interblocco, per consentire il funzionamento indipendente delle due porte (cod. V00148).
- 7** Sensori di sicurezza da prevedere.

Items required for basic operation of the interlock system:

- 1** Digital selector installed on each door: ET-DSEL or T-NFC for NEXT and NEPTIS PLUS.
- 2** Opening devices: choose between touch sensors or buttons to allow all users to open. Choose badge readers or keypads to allow only authorized personnel to open (see "General Sensors and Accessories").
- 3** Signaling lights for door state signaling (item T-LED or code V00175). Green light with closed doors on both signaling lights, red light on closed door if the other door is opened.
For signaling light management, a module UR2/E is required for each automation of type NEXT.
- 4** Door closing electromagnet or alternatively electric strikes requiring the provision of a lock with latch (see page "Closing systems" page 111).
- 5** Emergency door release button (refer to "General Accessories" page 117).
- 6** Interlock override ON/OFF switch, to allow independent operation of the two doors (code V00148).
- 7** Safety sensors to be provided for.



Interblocco tra due porte manuali a battente *Interlock between two manual swing doors*

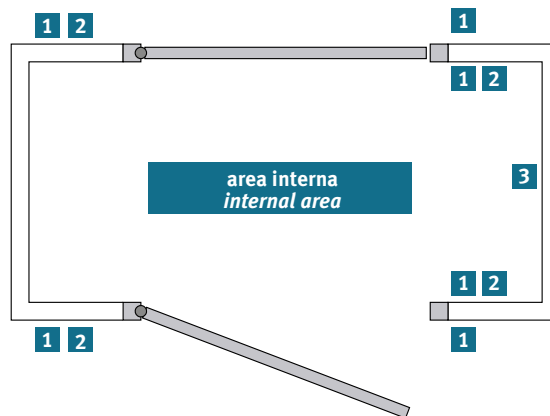
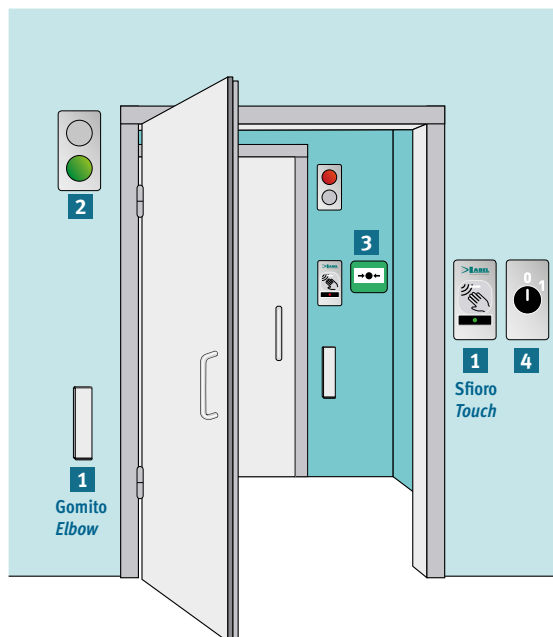

Articoli necessari al funzionamento base del sistema interblocco:

- 1** Dispositivi di apertura: scegliere pulsanti a **GOMITO** (cod. V01054) o a **SFIORO** (cod. V00216) per permettere l'apertura a tutti gli utenti, scegliere lettori di badge o tastiere a codice per consentire l'apertura solo a personale autorizzato (consultare la sezione "Sensori e accessori generici" pag. 117).
- 2** Semafori per segnalazione stato porta (art. V00175); luce verde con porte chiuse, luce rossa sulla porta chiusa in caso di apertura dell'altra.
- 3** Pulsante per l'apertura di emergenza delle porte (consultare la sezione "Accessori generici" pag. 117).
- 4** Selettore ON/OFF di esclusione interblocco, per consentire il funzionamento indipendente delle due porte (cod. V00148).

- Centralina logica per interblocco di 2 porte manuali a battente (cod. V00132) da posizionare nei pressi della porta.

- Incontro elettrico da abbinare alla serratura, già prevista nella scelta della porta, oppure elettromagnete di tenuta (consultare la pagina sistemi di chiusura per porte a battente).

- Kit Contatto Magnetico di Prossimità montato sull'anta (cod. H-KMC197).

Items required for basic operation of the interlock system:

- 1** Opening devices: choose **ELBOW** buttons (code V01054) or **TOUCH** buttons (code V00216) to allow all users to open, choose badge readers or keypads to allow only authorized users to open (see "General Sensors and Accessories" page 117).
- 2** Signaling light for door status signaling (item V00175); green light with closed doors, red light on closed door if the other door is opened.
- 3** Emergency door release button (refer to "General Accessories" page 117).
- 4** Interlock override ON/OFF switch, to allow independent operation of the two doors (code V00148).

- Logic unit for interlocking 2 manual swing doors (code V00132) to be positioned near the door.

- Electric strike to be paired with the lock, already provided in the selection of the door, or sealing electromagnet (see page closing systems for swing doors).

- Magnetic proximity contact kit mounted on the leaf (code H-KMC197).

ACCESSORI ACCESSORIES			
	V00175S	Scatola da applicare per semaforo (finitura argento) <i>Box to be applied for signaling light (silver finish)</i>	1
	V00176S	Scatola da applicare per semaforo (finitura nero) <i>Box to be applied for signaling light (black finish)</i>	1
	V00175	Semaforo di segnalazione rosso/verde (finitura anodizzata argento) <i>Red/green signaling light (silver anodized finish)</i>	1
	V00176	Semaforo di segnalazione rosso/verde (finitura anodizzata nera) <i>Red/green signaling light (black anodized finish)</i>	1
	T-LED	Semaforo di segnalazione rosso/verde in contenitore ABS bianco solo per porte automatiche <i>Red/green signaling light in white ABS container for automatic doors only</i>	1
	V00132	Centralina di controllo per interblocco di 2 porte a battenti manuali, completa di alimentatore 12VCC <i>Control unit for interlock of 2 manual swing doors, complete with 12VDC power supply</i>	1
	H-KCM197	Kit contatto magnetico montato su anta a battente <i>Magnetic contact kit mounted on swing door</i>	1
	V00269	Pulsante attivazione per uscite di emergenza colore verde con contatto N.C. <i>Green activation button for emergency exits with N.C. contact</i>	1
	V00270	Pulsante attivazione per uscite di emergenza colore verde con contatto N.A. <i>Green activation button for emergency exits with N.O. contact</i>	1
	V01204	UR24E Modulo di interblocco e segnalazioni opzionali per automazioni porte scorrevoli <i>UR24E Interlocking module and optional signals for sliding doors automations</i>	1
	V01202	UR2 Modulo relè 24V per automazioni NEXT <i>UR2 24V relay module for NEXT automations</i>	1
	V00148	Selettore ON / OFF di esclusione interblocco, per consentire il funzionamento indipendente delle due porte <i>Interlock override ON/OFF switch, to allow independent operation of the two doors</i>	1
 	T-LESS	Sensore a sfioramento a parete colore bianco <i>Wall-mount touch sensor (white)</i>	1
 	T-LESSB	Sensore a sfioramento a parete colore nero <i>Wall-mount touch sensor (black)</i>	1
	V00216	CLEARWAVE Sensore a sfioramento a parete <i>CLEARWAVE Wall-mounted contactless sensor</i>	1
	V01054	OT-3S Pulsante a gomito colore argento <i>OT-3S Elbow button silver colour</i>	1



ELETTRBLOCCHI LOCKS			
	ET-EBSFSAK	Elettroblocco Slim FAIL SAFE con sensore stato porta (in assenza di alimentazione sblocca le ante) <i>FAIL SAFE slim electric lock with door status microswitch (releases the door in power off)</i>	
	ET-EBSFSEK	Elettroblocco Slim FAIL SECURE con sblocco manuale EV-EBSSMA e sensore stato porta (mantiene le ante bloccate in assenza alimentazione) <i>FAIL SECURE electric lock with EV-EBSSMA manual release and door status microswitch (keep the door locked in power off)</i>	
	ET-EBSBISK	Elettroblocco Slim BISTABILE con sblocco manuale e sensore stato porta (mantiene lo stato in cui si trova in assenza di alimentazione) <i>BISTABLE electric lock with manual release and door status microswitch (the lock maintains its status in power off)</i>	
	H-V01180	Elettroblocco per porte ermetiche <i>Electric lock for hermetical doors</i>	
	EV-SPCDX	Sensore di porta chiusa destra (conf. 2 pz.) <i>Closed door sensor right (pack 2 pcs.)</i>	
	EV-SPCSX	Sensore di porta chiusa sinistra (conf. 2 pz.) <i>Closed door sensor left (pack 2 pcs.)</i>	
ACCESSORI ACCESSORIES			
	V01204	UR24E Modulo di interblocco e segnalazioni opzionali per automazioni porte scorrevoli <i>UR24E Interlocking module and optional signals for sliding doors automations</i>	
	V00175	Semaforo di segnalazione rosso/verde (finitura anodizzata argento) <i>Red/green signaling light (silver anodized finish)</i>	
	V00176	Semaforo di segnalazione rosso/verde (finitura anodizzata nera) <i>Red/green signaling light (black anodized finish)</i>	
	T-LED	Semaforo di segnalazione rosso/verde in contenitore ABS bianco <i>Red/green signaling light in white ABS container for automatic doors only</i>	

DISPOSITIVI DI IMPULSO PULSE DEVICES		
	R01111	SPYCO/1E trasmettitore monocanale per azionamento a distanza <i>SPYCO/1E single-channel transmitter for remote operation</i>
	R03002	SPYCO/3E trasmettitore tricanale per azionamento a distanza <i>SPYCO/3E three-channel transmitter for remote operation</i>
	EN-RF1	EN-RF1 ricevente monocanale gamma ETERNA e NEPTIS <i>EN-RF1 single-channel receiver ETERNA and NEPTIS Range</i>
	NEXT-RX	NEXT-RX ricevente monocanale Gamma NEXT <i>NEXT-RX single-channel receiver NEXT Range</i>
	T-LESS	Sensore a sfioramento a parete colore bianco <i>Wall-mount touch sensor (white)</i>
	T-LESSB	Sensore a sfioramento a parete colore nero <i>Wall-mount touch sensor (black)</i>
	V00216	CLEARWAVE - Sensore a sfioramento a parete <i>CLEARWAVE Wall-mounted contactless sensor</i>
	V01054	OT-3S - Pulsante a gomito colore argento <i>OT-3S - Silver-coloured elbow button</i>
	V01054.2	Pulsante maggiorato a gomito ES-P SILVER <i>Elbow button ES-P SILVER</i>
	V00164	Pulsante emergenza a fungo con contatto N.A. standard NERO <i>Emergency mushroom button with N.O. contact, standard BLACK</i>
	CL1425	Pulsante emergenza a fungo <i>Emergency mushroom button</i>
	HB-DSEL	Programmatore digitale HOSPITAL colore bianco per automazioni a tenuta semplice con brushless e NEXT a battente <i>White HOSPITAL digital programmer for simple sealing automations with brushless motor and NEXT swing doors automation</i>
	T-NFC	Programmatore digitale NFC per automazione HOSPITAL brushless <i>NFC digital programmer for HOSPITAL brushless automation</i>
	V00160	Pulsante a barra in gomma atossica comprimibile <i>Bar push button in compressible non-toxic rubber</i>

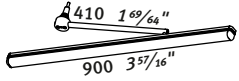
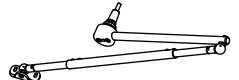

DISPOSITIVI DI SICUREZZA SAFETY DEVICES		
	V00218	OA PRESENCE-T - Sensore di sicurezza ad infrarossi attivi con test di sicurezza EN12978 colore nero <i>OA PRESENCE-T - Active infrared safety sensor with safety test EN12978 black colour</i>
	H-V00217P	OA PRESENCE-T - Sensore con kit di montaggio con base piana (carter tenuta ermetica e imbotte commerciale) <i>OA PRESENCE-T - Sensor with mounting kit with flat base (hermetically sealing carter and commercial wall frame)</i>
	H-V00217S	OA PRESENCE-T - Sensore con kit di montaggio con base stondata (carter tenuta semplice e imbotte di fornitura LABEL) <i>OA PRESENCE-T - Sensor with mounting kit with rounded base (simple sealing carter and LABEL wall frame)</i>
	H-V00221L	OA-EDGE-T 340 L SENSORE DI SICUREZZA 340 mm 1 modulo safety test chiusura SX <i>OA-EDGE-T 340 L</i> <i>SAFETY SENSOR, 340 mm (13 3/8"), 1 module, safety test, LH closing</i>
	H-V00221R	OA-EDGE-T 340 R SENSORE DI SICUREZZA 340 mm 1 modulo safety test chiusura DX <i>OA-EDGE-T 340 R</i> <i>SAFETY SENSOR, 340 mm (13 3/8"), 1 module, safety test, RH closing</i>
	H-V00222L	OA-EDGE-T 900 L SENSORE DI SICUREZZA 900 mm 1 modulo safety test chiusura SX <i>OA-EDGE-T 900 L</i> <i>SAFETY SENSOR, 900 mm (35 7/16"), 1 module, safety test, LH closing</i>
	H-V00222R	OA-EDGE-T 900 R SENSORE DI SICUREZZA 900 mm 1 modulo safety test chiusura DX <i>OA-EDGE-T 900 R</i> <i>SAFETY SENSOR, 900 mm (35 7/16"), 1 module, safety test, RH closing</i>
	V00254	FLATSCAN Nero - Laser scanner di sicurezza per porte battenti (coppia) <i>FLATSCAN Black - Safety laser scanner for swing doors (pair)</i>
	V00255	FLATSCAN Argento - Laser scanner di sicurezza per porte battenti (coppia) <i>FLATSCAN Silver - Safety laser scanner for swing doors (pair)</i>
ACCESSORI ACCESSORIES		
	V00155	Guarnizione mobile a pavimento <i>Mobile floor seal</i>
	V00156	Protezione dita per porte a battente 2015 mm <i>Swing door finger protector 2015 mm (79 1/16")</i>
BATTERIE BATTERIES		
	HB-BATHE	Dispositivo a batteria per apertura di emergenza solo per porta automatica scorrevole a tenuta ermetica <i>Battery-operated emergency opening device, only for hermetically sealing automatic sliding doors</i>
	HB-BAT2P	Dispositivo a batteria per funzionamento in mancanza di energia elettrica <i>Battery device for temporary operation in case of blackout</i>
	V01211	N-BAT/E Dispositivo esterno a batteria per NB-SMP (solo per apertura) <i>N-BAT/E External battery for NB-SMP (opening only)</i>
	HB-BATNX	Maggiorazione per Batteria d'emergenza per NEXT 75/NEXT 150 <i>Additional cost for Emergency battery for NEXT 75/NEXT 150</i>

ACCESSORI ACCESSORIES		
--------------------------	---	---

Accessori per NB-SMP / Accessories for NB-SMP

	H-BDT2FE	Braccio dritto a TIRARE in acciaio per ingressi ospedalieri <i>Steel PULL arm for hospital entrances</i>
	BSS2FE	Braccio articolato a SPINGERE in acciaio <i>Steel articulated PUSH arm</i>
	EXT-B-Z	Perno per estensione albero 24 mm <i>Pin for shaft extension 24 mm (1 1/4")</i>
	EXT-C-Z	Perno per estensione albero 48 mm. <i>Pin for shaft extension 48 mm (1 7/8")</i>

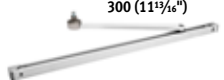
Accessori per NEXT / Accessories for NEXT

	HB-NEXTBDT	Braccio dritto a tirare in acciaio per ingressi ospedalieri per porte HB-B75 e HB-B150 <i>Pull sliding arm in steel for hospital entrances for doors HB-B75 and HB-B150</i>
	NEXT-BAS	Braccio dritto a spingere in acciaio per ingressi ospedalieri per porte HB-B75 e HB-B150 <i>Push sliding arm in steel for hospital entrances for doors HB-B75 and HB-B150</i>
	NEXT-EXT	Perno per estensione albero 25 mm per porte HB-B75 e HB-B150 <i>Arm extension shaft 25 mm (1") for doors HB-B75 and HB-B150</i>

ACCESSORI ACCESSORIES		
--------------------------	---	---





	H-KNEXT-BDT	Kit trasformazione per porta a battente A TIRARE servoassistita composto da: - Automazione battente A TIRARE per interni con batteria - Braccio dritto a TIRARE - Perno per estensione albero - Pulsante a gomito colore argento (OT-3S) <i>Transformation kit for servo-assisted PULL swing door composed by:</i> - Automation for interior PULL swing door with battery - PULL sliding arm - Arm extension shaft - Elbow button silver colour (OT-3S)
	H-KNEXT-BDS	Kit trasformazione per porta a battente A SPINGERE servoassistita composto da: - Automazione battente A SPINGERE per interni con batteria - Braccio dritto a SPINGERE - Perno per estensione albero - Pulsante a gomito colore argento (OT-3S) <i>Transformation kit for servo-assisted PUSH swing door composed by:</i> - Automation for interior PUSH swing door with battery - PUSH sliding arm - Arm extension shaft - Elbow button silver colour (OT-3S)
	H-KNEXT-BAS	Kit trasformazione per porta a battente A SPINGERE servoassistita composta da: - Automazione battente A SPINGERE per interni con batteria - Braccio articolato A SPINGERE - Perno per estensione albero - Pulsante a gomito colore argento (OT-3S) <i>Transformation kit for servo-assisted PUSH swing door composed by:</i> - Automation for interior PUSH swing door with battery - PUSH articulated arm - Arm extension shaft - Elbow button silver colour (OT-3S)

Tabella colori per pannelli in laminato
Colour chart for laminated panels

405	410	406	411	810	1813	418	409	813
414	415	416	413	812	869	420	1816	893
868	1810	867	1820	854	478	479	1819	475
1809	477	480	870	871	472	879	421	487
857	853	482	847	499	838	859	1804	852
428	851	849	496	430	1818	484	801	802
858	454	453	846	486	445	460	1823	451
845	440	450	490	1824	437	459	444	457
850	856	476	488	446	842	843	452	441
467	412	466	464	463	469	860	468	862
1812	861	835	834	823	1822	431	432	891
831	435	836	832	1828	898	897	837	894
892	1826	1801	890	1805	828	830	1825	494
427	1821	424	425	1827	423	498	NEW	

Tabella esplicativa non impegnativa che corrisponde a colori serie colours su ABET finitura SEI.
Colori indicativi, suscettibili di variazioni dovute alla fedeltà di stampa.

The colours in this chart, which correspond to the colours series on ABET HPL with SEI finishes, are intended to be illustrative and may vary.
Colours are intended as examples only and may vary as a result of printing quality.

	
H-FIN	Finitura profili e Carter in simil Inox <i>Stainless steel-like finish for profiles and casings</i>
H-FOX	Finitura profili e carter ARGENTO <i>SILVER finish for profiles and casings</i>
H-FRAL	Finitura profili e carter RAL <i>RAL finish for profiles and casings</i>
H-FSVIN	Finitura profili e Carter in simil Inox per soluzione vetrate <i>STAINLESS STEEL finish for profiles and casings for glass solutions</i>
H-FSVOX	Finitura profili e carter ARGENTO per soluzioni vetrate <i>SILVER finish for profiles and casings for glass solutions</i>
H-FSVRAL	Finitura profili e carter RAL per soluzioni vetrate <i>RAL finish for profiles and casings for glass solutions</i>
H-FRAL-I	Verniciatura RAL lamiera INOX/galvanizzato <i>RAL painted for a Stainless or Galvanized Steel Sheets</i>
H-FPSD	Stampa digitale per pannelli in laminato <i>Digital print for HPL panels</i>



A TI AIUTIAMO A CONFIGURARE IL TUO IMPIANTO / WE HELP YOU SET UP YOUR SYSTEM

1 Scorrevole
Sliding doors | Battente
Swing doors

2 Automatica
Automatic | Manuale
Manual

3 n. Ante
Number of leaves

4 Quantità porte
Number of doors

5 Destra
Right | Sinistra
Left

6 Spingere
Push | Tirare
Pull

7 Ermetica
Hermetically
sealing | Semplice
Simple sealing

8 Acciaio INOX
Stainless
Steel | Vetro
Glass | Laminato / HPL
Tabella colori/Colour chart
pag./page 120

9 Altezza vano finito
Finished opening height | Larghezza vano finito
Finished opening width

10 Imbotte
Wall frame | Semi-Imbotte
Semi-Wall frame | Senza Imbotte
Without Wall frame

11 Lastre in piombo
Lead plates

12 Maniglie per porte
scorrevoli
Handles for sliding doors
pag./page 108 | Maniglioni alzanti per porte
scorrevoli ermetiche
Lifting pull handles for
hermetic sliding doors
pag./page 108 | Maniglie per porte battente
Handles for swing doors
pag./page 109

Altro / Other







.....

.....

In fase di conferma d'ordine è importante indicare se la consegna del materiale avverrà con vostro mezzo oppure con corriere, in questo ultimo caso è opportuno concordare un imballo adeguato per preservare i prodotti; infatti, a vostra richiesta, LABEL potrà approntare imballi in cassa di legno.



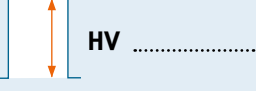
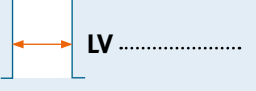
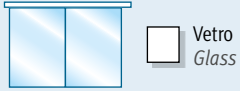

When confirming the order, please indicate if the delivery of the material will be carried out by your means of transport or by carrier. In the latter case, suitable packing shall be agreed upon, in order to protect the products; indeed, on your request, Label can provide special packing in wooden crates.

B PORTA VETRATA AUTOMATICA SCORREVOLE ICU-CCU/ GLAZED AUTOMATIC SLIDING DOOR - ICU-CCU





<p>Automatica <i>Automatic</i></p>  <p><input type="checkbox"/> Tenuta ermetica <i>Hermetically sealing</i></p> <p><input type="checkbox"/> Tenuta semplice <i>Simple sealing</i></p>	<p>Manuale <i>Manual</i></p>  <p><input type="checkbox"/> Tenuta ermetica <i>Hermetically sealing</i></p> <p><input type="checkbox"/> Tenuta semplice <i>Simple sealing</i></p>	<p>Automatica con dispositivo TLCA <i>Automatic with TLCA device</i></p>  <p><input type="checkbox"/> Tenuta semplice <i>Simple sealing</i></p>	<p>Manuale con dispositivo TLCA <i>Manual with TLCA device</i></p>  <p><input type="checkbox"/> Tenuta semplice <i>Simple sealing</i></p>
<p>Altezza vano finito <i>Finished opening height</i></p>  <p>HV</p>	<p>Larghezza vano finito <i>Finished opening width</i></p>  <p>LV</p>	<p>Vetrazione <i>Glazing</i></p>  <p><input type="checkbox"/> Vetro <i>Glass</i></p>  <p><input type="checkbox"/> Smart <i>Glass</i></p>	

C OPZIONALI / *OPTIONS*

DISPOSITIVI DI COMANDO / *CONTROL DEVICES*

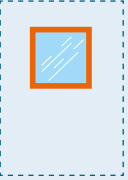
<p>Pulsante a barra <i>Bar Push button</i></p>  <p><input type="checkbox"/></p> <p><input type="checkbox"/></p>	<p>Sensore per attivazione e sicurezza <i>Activation and safety sensors</i></p>  <p><input type="checkbox"/></p> <p><input type="checkbox"/></p>	<p>Pulsante a gomito color argento <i>Elbow button silver colour</i></p>  <p><input type="checkbox"/></p> <p><input type="checkbox"/></p>	<p>Clearwave sensore a sfioramento a parete <i>Clearwave Touch wall sensor</i></p>  <p><input type="checkbox"/></p> <p><input type="checkbox"/></p>
--	---	--	--

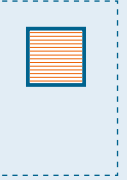
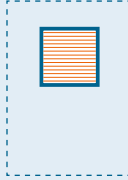
ACCESSORI / *ACCESSORIES*

<p><input type="checkbox"/> Visiva <i>Vision panel</i> 400x400 mm <i>(15 3/4" x 15 3/4")</i></p> 	<p><input type="checkbox"/> Visiva <i>Vision panel</i> 600x400 mm <i>(23 3/8" x 15 3/4")</i></p> 	<p><input type="checkbox"/> Visiva con tendina manuale <i>Vision panel with manual curtain</i></p> 	<p><input type="checkbox"/> Visiva con tendina automatica <i>Vision panel with automatic curtain</i></p> 	<p><input type="checkbox"/> Visiva RX <i>Vision panel X-ray</i> mm</p> 
--	--	--	--	--

Altro / *Other*

.....

.....



PERMEABILITÀ ALL'ARIA - ERMETICITÀ

HB-SALTE1, HB-SALTE1, HB-SAVTE, HB-BAL1, HB-BAL2 con estensione per H-BML2 e H-BML1

ISOLAMENTO ACUSTICO

HB-SALTE1, HB-SALTS1, H-BML 1 con estensione per HB-BAL

LABEL S.p.A. DICHIARA che i seguenti prodotti ospedalieri sono conformi alle seguenti direttive:

DIRETTIVA COMPATIBILITÀ ELETTROMAGNETICA "EMC 2014/30/UE"

- **Norma EN 61000-6-2**
Norma sull'immunità ai disturbi elettromagnetici in ambiente Industriale.
- **Norma EN 61000-6-3**
Norma sull'emissione dei disturbi elettromagnetici in ambienti residenziali, commerciali e dell'industria leggera.

DIRETTIVA BASSA TENSIONE "LVD 2014/35/UE"

- **Norma EN 60335-2-103**
Norma sulla sicurezza degli apparecchi elettrici d'uso domestico e similare, contro i rischi di natura elettrica, meccanica e termica.

DIRETTIVA MACCHINE "2006/42/CE"

- **Norma EN 13849-1**
Parti del sistema di comando legate alla sicurezza. Parte 1: Principi generale per la progettazione.
- **Norma EN 13849-2**
Parti del sistema di comando legate alla sicurezza. Parte 2: Validazione.
- **Norma EN 16005**
Chiusura pedonali automatiche - Sicurezza in uso. Requisiti e metodi di prova.

CERTIFICAZIONE PORTA AUTOMATICA SCORREVOLE A CHIUSURA ERMETICA HB-SALTE1-S, HB-SAVTE

- **UNI EN 1026**
Permeabilità all'aria per porte e finestre. Metodo di prova.
- **UNI EN 12207**
Permeabilità all'aria per porte e finestre. Classificazione. Automazione ETH/E
- **UNI EN ISO 10140 e UNI EN ISO 717**
Misurazione dell'isolamento acustico.

CERTIFICAZIONE PORTA AUTOMATICA A BATTENTE MOD. "I44-NEPTIS-SS M"

- **UNI EN ISO 10140-2**
Misurazione in laboratorio dell'isolamento acustico di edifici e di elementi di edificio. Parte 2: Misurazione dell'isolamento acustico per via aerea.
- **UNI EN ISO 717-1**
Valutazione dell'isolamento acustico in edifici e di elementi di edificio. Parte 1: Isolamento acustico per via aerea.

CERTIFICAZIONE TUV

- **DIN18650-1**
- **DIN18650-2**
- **EN16005**
- Automazione per porta a battente NEPTIS: **N. G577-2**
- Automazione per porta a sfondamento: **N. G589-2**
- Automazione per porte scorrevoli ridondanti REVOLUS: **N. G623-4**
- Automazione per porta scorrevole ETERNA: **N. G662-2**

STANDARD UL325

(Certificate number UL-CA-2012338-0 / UL-US-2015511-0)

- Automazione per porta a battente NEXT: **File E520015**
- Automazione per porta scorrevole ETERNA: **File E520015**
- Automazione per porta a battente NEPTIS PLUS: **File E520015**

CERTIFICAZIONE QUALITÀ AZIENDALE LABEL S.P.A.

- **UNI EN ISO 9001**





AIR - PERMEABILITY

HB-SAITE1, HB-SALTE1, HB-SAVTE, HB-BAL1, HB-BAL2 with extension for H-BML2 e H-BML1

SOUND INSULATION

HB-SALTE1, HB-SALTS1, H-BML 1 with extension for HB-BAL

LABEL S.p.A. DECLARES that the following hospital products comply with the following directives:

COMPATIBILITY DIRECTIVE "EMC 2014/30/UE"

- **EN 61000-6-2**
Standard on EMC immunity in industrial environments.
- **EN 61000-6-3**
Standard on electromagnetic emissions in residential, commercial and light industry environments.

LOW VOLTAGE DIRECTIVE "LVD 2014/35/UE"

- **EN 60335-2-103**
Standard on the safety of household and similar electrical appliances, against electrical, mechanical and heat-related risks.

MACHINE DIRECTIVE "2006/42/EC"

- **EN 13849-1**
Safety-related parts of control systems.
Part 1: General principles for design.
- **EN 13849-2**
Safety-related parts of control systems.
Part 2: Validation.
- **EN 16005**
Power operated pedestrian doorsets - Safety in use.
Requirements and test methods.

**CERTIFICATION HERMETICALLY SEALED AUTOMATIC SLIDING DOOR
HB-SALTE1-S, HB-SAVTE**

- **UNI EN 1026**
Air permeability for doors and windows. Test method.
- **EN 12207**
Air permeability for doors and windows. Classification. Automation ETH/E
- **EN ISO 10140 e UNI EN ISO 717**
Measurement of airborne sound insulation.

CERTIFICATION AUTOMATIC SWING DOOR MOD. "I44-NEPTIS-SS M"

- **UNI EN ISO 10140-2**
Laboratory measurement of sound insulation of building elements.
Part 2: Measurement of airborne sound insulation.
- **UNI EN ISO 717-1**
Rating of sound insulation in buildings and of building elements.
Part 1: Airborne sound insulation.

CERTIFICATION TUV

- **DIN18650-1**
- **DIN18650-2**
- **EN16005**
- Automation for swing door NEPTIS: **N. G577-2**
- Automation for sliding door EVOLUS: **N. G589-2**
- Automatic sliding door with break-out system: **N. G623-4**
- Automation for redundant sliding door: **N. G662-2**

STANDARD UL325

- (Certificate number UL-CA-2012338-0 / UL-US-2015511-0)
- Automation for swing door NEXT: **File E520015**
 - Automation for sliding door ETERNA: **File E520015**
 - Automation for swing door NEPTIS PLUS: **File E520015**



LABEL S.P.A. QUALITY CERTIFICATION

- **UNI EN ISO 9001**



CONDIZIONI GENERALI
DI VENDITA

*GENERAL TERMS
OF SALE*

TRASPORTO DEL MATERIALE, IMBALLO E STOCCAGGIO:

In generale, per tutte le Modalità di trasporto, il materiale ancorché imballato in cassa chiusa o gabbia aperta **NON può essere trasportato da mezzi aperti senza tetto o telone, se non per brevissimi tratti limitatamente alle fasi di carico/scarico o in caso in cui le condizioni atmosferiche ne consentano l'eccezionalità del passaggio all'aperto e comunque l'autorizzazione è soggetta e subordinata alla decisione della Label S.p.A.**

MODALITÀ A VISTA:

È possibile solo per trasporti brevi, a cura del Cliente, di Label o di un trasportatore dedicato dotato di mezzo telonato, per materiale che è scaricato e montato direttamente in cantiere.

L'imballo è a vista su cavalletto, perfettamente bloccato con regge in nylon rinforzato, e il prodotto è protetto sugli angoli con angolari in cartone pressato; protezione superficiale con film in PVC.

• PROCEDURA DI SCARICO

Evitare durante lo scarico che i pannelli si urtino, graffino o si danneggino; è consigliato lo scarico a mano, un pannello alla volta, Segnalare se è previsto lo scarico con sollevamento del cavalletto tramite gru o montacarichi: il mancato avvertimento da parte del cliente di questa modalità farà scadere in qualsiasi modo la garanzia del prodotto.

• STOCCAGGIO

Nella modalità a VISTA è vietato ogni tipo di stoccaggio tranne quello limitato all'attesa del montaggio entro le 24 ore dallo scarico. In questo caso la merce deve essere posizionata a piè d'opera ed è necessario proteggere il materiale con Cartoni, Nylon o altro materiale "pulito" reperibile in cantiere.

Si considera il luogo a piè d'opera come locale finito, protetto da agenti atmosferici e con temperature comprese tra i 10° e i 30°C e con il 40 - 65% di UR (umidità Relativa).

Se, per qualsiasi motivo, il materiale sosterà oltre le 24 ore è necessario provvedere in loco all'utilizzo di casse/gabbie o cavalletti protetti che garantiscano una protezione contro l'urto e contro la sedimentazione di polvere, anche se permangono le caratteristiche ambientali espresse precedentemente per temperatura e UR.

MODALITÀ IN CASSA/GABBIA: TRASPORTO VIA TERRA

Adatto per trasporti sia brevi che lunghi. La cassa non necessita di trattamento di fumigazione, a meno che non lo richieda espressamente il cliente o il luogo di destinazione.

Il materiale è imballato con legacci e protezioni in film plastico in modo da non muoversi all'interno della cassa/gabbia; le parti cartonate saranno semplicemente impilate e incastrate tra loro, come la buona regola lo richiede; scatole di piccole dimensioni (inferiori a 40 x 40 x 40 cm) saranno inserite in imballi cartonati di maggior dimensione e/o fissate con apposito nastro adesivo o legacci alle pareti o ai morali interni alla cassa/gabbia.

• PROCEDURA DI SCARICO

Utilizzare idoneo mezzo di sollevamento:

- muletto o grillo dotato di forche sufficientemente lunghe per impegnare totalmente un lato della cassa/gabbia,
- gru o carroponte dotato di cinghie o benne di larghezza e lunghezza tali da abbracciare totalmente la cassa/gabbia dalla base al tetto.

• STOCCAGGIO

È vietato lo stoccaggio in luogo non coperto, ovvero è consentito lo stoccaggio in luogo coperto ed asciutto per un tempo limitato di 48-72 ore dallo scarico.

In questo caso la merce deve essere posizionata in locali appositi; la cassa/gabbia deve essere sollevata dal pavimento nel caso questo non sia finito almeno al grezzo; è necessario segnalare il materiale con nastro evidenziatore o altro dispositivo di segnalazione per la salvaguardia dell'involucro esterno.

Si considera il luogo a piè d'opera come locale finito, protetto da agenti atmosferici e con temperature comprese tra i 10° e i 30°C e con il 40 - 65% di UR (umidità Relativa).

Se, per qualsiasi motivo, il materiale sosterà più a lungo delle previste 48-72 ore è necessario provvedere a togliere il materiale dall'imballo e porlo a dimora in luogo perfettamente asciutto (massimo 35° di UR) ad una temperatura compresa tra i 15-30°, oppure a porlo in altro contenitore di imballo che ne garantisca le condizioni termiche, igroscopiche e protettive dagli urti e dagli schiacciamenti, nonché dalla sedimentazione di polvere e/o sporco in genere, anche se permangono le caratteristiche ambientali espresse precedentemente per temperatura e UR.

MODALITÀ IN CASSA/GABBIA: TRASPORTO VIA NAVE

Adatto per trasporti sia brevi che lunghi; la cassa subirà un trattamento di fumigazione e verrà previsto un sacco barriera integrale che avvolgerà tutto il materiale precedentemente già sistemato con legacci e protezioni in film plastico, in modo che non si muova all'interno della cassa/gabbia.

Le parti cartonate saranno semplicemente impilate e incastrate tra loro, come la buona regola lo richiede; scatole di piccole dimensioni (inferiori a 40 x 40 x 40 cm) saranno inserite in imballi cartonati di maggior dimensione e/o fissate con apposito nastro adesivo o legacci alle pareti o ai morali interni alla cassa/gabbia.

• PROCEDURA DI SCARICO

Utilizzare idoneo mezzo di sollevamento:

- muletto o grillo dotato di forche sufficientemente lunghe per impegnare totalmente un lato della cassa/gabbia,
- gru o carroponte dotato di cinghie o benne di larghezza e lunghezza tali da abbracciare totalmente la cassa/gabbia dalla base al tetto.

• STOCCAGGIO

È vietato lo stoccaggio in luogo non coperto, ovvero è consentito lo stoccaggio in luogo coperto ed asciutto per un tempo limitato di 30 giorni dallo scarico. In questo caso la merce deve essere posizionata in locali appositi; la cassa/gabbia deve essere sollevata dal pavimento nel caso questo non sia finito almeno al grezzo; è necessario segnalare il materiale con nastro evidenziatore o altro dispositivo di segnalazione per la salvaguardia dell'involucro esterno.

Si considera il luogo a piè d'opera come locale finito, protetto da agenti atmosferici, con temperature comprese tra i 10° e i 40°C, con il 40 - 65% di UR (umidità Relativa).

Se il materiale per qualsiasi causa sosterà più a lungo di 30 giorni, alle condizioni ambientali espresse precedentemente per temperatura e UR, sarà necessario togliere il materiale dall'imballo e porlo a dimora in luogo perfettamente asciutto (massimo 35° di UR) ad una temperatura compresa tra i 15°-30° oppure a porlo in altro contenitore di imballo che ne garantisca le condizioni termiche, igroscopiche e protettive dagli urti, dagli schiacciamenti e dalla sedimentazione di polvere e/o sporco in genere.

MODALITÀ IN CASSA/GABBIA: TRASPORTO VIA AEREA

Adatto per trasporti sia brevi che lunghi. La cassa subirà un trattamento di fumigazione e verrà previsto un involucro WCI che avvolgerà tutto il materiale, precedentemente sistemato con legacci e protezioni in film plastico, in modo da non muoversi all'interno della cassa/gabbia. Per tempi di stoccaggio fino a 30 giorni è necessario chiedere l'imballo con "sacco barriera".

Le parti cartonate saranno semplicemente impilate e incastrate tra loro, come la buona regola lo richiede; scatole di piccole dimensioni (inferiori a 40 x 40 x 40 cm) saranno inserite in imballi cartonati di maggior dimensione e/o fissate con apposito nastro adesivo o legacci alle pareti o ai morali interni alla cassa/gabbia.

• PROCEDURA DI SCARICO

Utilizzare idoneo mezzo di sollevamento:

- muletto o grillo dotato di forche sufficientemente lunghe per impegnare totalmente un lato della cassa/gabbia,
- gru o carroponte dotato di cinghie o benne di larghezza e lunghezza tali da abbracciare totalmente la cassa/gabbia dalla base al tetto.

• STOCCAGGIO

È vietato lo stoccaggio in luogo non coperto, ovvero è consentito lo stoccaggio in luogo coperto ed asciutto per un tempo limitato di 7 giorni dallo scarico (che diventano 30 giorni se l'imballo è completo di sacco barriera). In questo caso la merce deve essere posizionata in locali appositi; la cassa/gabbia deve essere sollevata dal pavimento nel caso questo non sia finito almeno al grezzo; è necessario segnalare il materiale con nastro evidenziatore o altro dispositivo di segnalazione per la salvaguardia dell'involucro esterno.

Si considera il luogo a piè d'opera come locale finito, protetto da agenti atmosferici, con temperature comprese tra i 10° e i 40°C, con il 40 - 65% di UR (umidità Relativa).

Se il materiale per qualsiasi causa sosterà più a lungo di quanto sopra indicato, alle condizioni ambientali espresse precedentemente per temperatura e UR, sarà necessario togliere il materiale dall'imballo e porlo a dimora in luogo perfettamente asciutto (massimo 35° di UR) ad una temperatura compresa tra i 15-30° oppure a porlo in altro contenitore di imballo che ne garantisca le condizioni termiche, igroscopiche e protettive dagli urti, dagli schiacciamenti e dalla sedimentazione di polvere e/o sporco in genere.

MATERIAL TRANSPORT, PACKAGING, AND STORAGE:

In general, for all transport modes, the material, although packaged in a closed box or open cage, CANNOT be transported by open vehicles without cover or tarpaulin, except for very short periods limited to loading/unloading or in case the weather conditions allow the exception of the passage without cover or tarpaulin and in any case the authorization is subject to the decision of Label S.p.A.

OPEN VIEW MODE:

It is only possible for short transport, by the Customer, by Label or by a dedicated carrier equipped with a sheeted vehicle, for material that is unloaded and mounted directly at the site.

The packaging is visible on a stand, perfectly locked with reinforced nylon straps, and the product is protected on the corners with pressed cardboard corners; surface protection with PVC film.

• UNLOADING PROCEDURE

Avoid panels colliding, scratching, or damaging during unloading; manual unloading is recommended, one panel at a time. Notify if the stand is to be unloaded by crane or hoist: customer failure to notify this mode will void product warranty.

• STORAGE

In OPEN VIEW mode, all types of storage are prohibited, except a limited storage period waiting for installation within 24 hours of unloading. In this case, the goods must be placed on site and it is necessary to protect the material with Cardboard, Nylon, or other "clean" material available at the site.

The storage area must be a finished room, protected from atmospheric agents and with temperatures between 50 °F and 86 °F and with 40 - 65% RH (relative humidity).

If, for any reason, the material will be stored for over 24 hours, it is necessary to provide on site the use of crates/cages or protected stands which guarantee protection against impact and settling of dust, even if the environmental characteristics stated previously related to temperature and RH remain unchanged.

CRATE/CAGE MODE: LAND TRANSPORT

Suitable for both short and long transports. The crate does not need fumigation treatment unless the customer or the place of destination expressly so requests. The material is packed with plastic film ties and guards so as not to move inside the crate/cage; the parts in cardboard will simply be stacked and interlocked, as good rule requires; small boxes (less than 40 x 40 x 40 cm - 15¾" x 15¾" x 15¾") will be inserted in larger sized cardboard packaging and/or fixed with appropriate adhesive tape or ties to the walls or joists inside the crate/cage.

• UNLOADING PROCEDURE

Use suitable lifting equipment:

- forklift or clevis with forks long enough to fully engage one side of the crate/cage,
- crane or bridge crane equipped with belts or buckets of such width and length as to completely embrace the crate/cage from the base to the roof.

• STORAGE

Storage in an uncovered place is prohibited, while storage in a covered and dry place is allowed for a limited time of 48-72 hours after unloading.

In this case the goods must be placed in special rooms; the crate/cage must not stand directly on the floor in case it is not finished at least roughly; it is necessary to highlight the material with marking tape or other signaling device for the protection of the external wrapping.

The storage area must be a finished room, protected from atmospheric agents and with temperatures between 50 °F and 86 °F and with 40 - 65% RH (relative humidity).

If, for any reason, the material is to stay longer than the expected 48-72 hours, it is necessary to remove the material from the packaging and to place it in a perfectly dry place (maximum 95 °F - RH) at a temperature of between 59 °F and 86 °F, or place it in another packaging container that guarantees its thermal, hygroscopic, and protective conditions against impacts and crushing, as well as settling of dust and/or dirt in general, even if the environmental characteristics previously stated for temperature and RH remain.

CRATE/CAGE MODE: TRANSPORT BY SEA

Suitable for both short and long transports; the crate shall undergo a fumigation treatment and a full barrier bag will be provided which will wrap all the material previously arranged with plastic film ties and guards, so that it does not move inside the crate/cage.

The parts in cardboard will simply be stacked and interlocked, as good rule requires; small boxes (less than 40 x 40 x 40 cm - 15¾" x 15¾" x 15¾") will be inserted in larger sized cardboard packaging and/or fixed with appropriate adhesive tape or ties to the walls or joists inside the crate/cage.

• UNLOADING PROCEDURE

Use suitable lifting equipment:

- forklift or clevis with forks long enough to fully engage one side of the crate/cage,
- crane or bridge crane equipped with belts or buckets of such width and length as to completely embrace the crate/cage from the base to the roof.

• STORAGE

Storage in an uncovered place is prohibited, while storage in a covered and dry place is allowed for a limited time of 30 days after unloading. In this case the goods must be placed in special rooms; the crate/cage must be lifted from the floor in case it is not finished at least roughly; it is necessary to highlight the material with marking tape or other signaling device for the protection of the external wrapping.

The storage area must be a finished room, protected from atmospheric agents, with temperatures between 50 °F and 104 °F and with 40 - 65% RH (relative humidity).

If, for any reason, the material is to stay longer than 30 days, under the temperature and relative humidity environmental conditions stated above, it is necessary to remove the material from the packaging and to place it in a perfectly dry place (maximum 95 °F - RH) at a temperature of between 59 °F and 86 °F, or place it in another packaging container that guarantees its thermal, hygroscopic, and protective conditions against impacts and crushing, as well as settling of dust and/or dirt in general.

CRATE/CAGE MODE: TRANSPORT BY AIR

Suitable for both short and long transports. The crate shall undergo a fumigation treatment and a WCI package will be provided which will wrap all the material previously arranged with plastic film ties and guards, so that it does not move inside the crate/cage. For storage times of up to 30 days, it is necessary to request a packaging with "barrier bag".

The parts in cardboard will simply be stacked and interlocked, as good rule requires; small boxes (less than 40 x 40 x 40 cm - 15¾" x 15¾" x 15¾") will be inserted in larger sized cardboard packaging and/or fixed with appropriate adhesive tape or ties to the walls or joists inside the crate/cage.

• UNLOADING PROCEDURE

Use suitable lifting equipment:

- forklift or clevis with forks long enough to fully engage one side of the crate/cage,
- crane or bridge crane equipped with belts or buckets of such width and length as to completely embrace the crate/cage from the base to the roof.

• STORAGE

Storage in an uncovered place is prohibited, while storage in a covered and dry place is allowed for a limited time of 7 days after unloading (that become 30 days if the packaging includes a barrier bag). In this case the goods must be placed in special rooms; the crate/cage must be lifted from the floor in case it is not finished at least roughly; it is necessary to highlight the material with marking tape or other signaling device for the protection of the external wrapping.

The storage area must be a finished room, protected from atmospheric agents, with temperatures between 50 °F and 104 °F and with 40 - 65% RH (relative humidity).

If, for any reason, the material is to stay longer than stated above, under the temperature and relative humidity environmental conditions stated above, it is necessary to remove the material from the packaging and to place it in a perfectly dry place (maximum 95 °F - RH) at a temperature between 59 °F and 86 °F, or place it in another packaging container that guarantees its thermal, hygroscopic, and protective conditions against impacts and crushing, as well as settling of dust and/or dirt in general.

1) Definizioni

- 1.1 Ai fini delle presenti condizioni generali di vendita (di seguito denominate, "Condizioni di Vendita"), i seguenti termini avranno il significato di seguito attribuito ad essi:
 - «Venditore» o «Label»: indica Label S.p.A.
 - «Acquirente»: indica qualsiasi società, ente o persona giuridica che acquisti i Prodotti dal Venditore;
 - «Prodotti»: indica i beni prodotti e/o assemblati e venduti dal Venditore;
 - «Ordine(i)»: indica ciascuna proposta di acquisto dei Prodotti inoltrata dall'Acquirente al Venditore tramite fax o email;
 - «Vendita/«»: indica ciascun contratto di vendita concluso a seguito del ricevimento da parte dell'Acquirente dell'accettazione scritta di ogni singolo Ordine, emessa dal Venditore.

2) Ambito di applicazione

- 2.1 Le presenti Condizioni di Vendita si applicano a tutte le Vendite di Prodotti concluse in tutto il mondo. Nel caso in cui vengano concordate per iscritto e sottoscritte dal Venditore e dall'Acquirente condizioni speciali che derogano alle presenti Condizioni di Vendita, tali condizioni speciali prevarranno e sostituiranno o integreranno le disposizioni delle presenti Condizioni di Vendita.
- 2.2 Il Venditore si riserva il diritto di aggiungere, modificare o eliminare singole previsioni delle presenti Condizioni di Vendita, rimanendo inteso che tali aggiunte, modifiche o cancellazioni si applicheranno a tutte le Vendite concluse a partire dal trentesimo giorno successivo alla notifica all'Acquirente delle nuove Condizioni di Vendita.

3) Ordini e Vendite

- 3.1 L'Acquirente dovrà inoltrare gli Ordini al Venditore tramite email al seguente indirizzo ordini@labelspa.it, o tramite fax al seguente numero [+39 0521 675222] indicando espressamente: la data di consegna prevista, la descrizione dei Prodotti, la quantità richiesta, il prezzo e i termini di consegna.
- 3.2 Ogni Ordine ricevuto da Label sarà processato e (i) accettato mediante l'emissione di una conferma d'ordine o (ii) rigettato mediante l'emissione di un report di diniego. Rimane inteso che in caso di discrepanza tra la data di consegna indicata nell'Ordine e la data di consegna specificata nella conferma d'ordine, quest'ultima prevarrà.
- 3.3 Il Venditore potrà, per specifiche ragioni legate a proprie esigenze produttive o al relativo mercato, fornire l'Acquirente attraverso qualsiasi altra società appartenente al Gruppo Label.
- 3.4 La Vendita dovrà ritenersi conclusa, secondo i termini e le condizioni stabilite nell'Ordine, nel momento in cui l'Acquirente riceve, da parte del Venditore, una conferma scritta (conferma che potrà anche essere inviata tramite email, fax o altri mezzi telematici) o, in assenza di tale conferma scritta, nel momento in cui i Prodotti sono consegnati all'Acquirente.
- 3.5 Gli Ordini regolarmente accettati dal Venditore non potranno essere annullati dall'Acquirente senza il consenso scritto del Venditore.

4) Prezzo dei Prodotti

- 4.1 I prezzi dei Prodotti saranno quelli indicati nel listino prezzi del Venditore in vigore al momento dell'invio dell'Ordine da parte dell'Acquirente o, qualora il Prodotto non sia inserito nel listino prezzi o il listino prezzi non sia disponibile, quelli indicati nell'Ordine e confermati per iscritto dal Venditore nella conferma dell'Ordine. Tali prezzi saranno calcolati Ex Works (ICC INCOTERMS 2010), al netto dell'IVA e di ogni sconto.
- 4.2 Il Venditore si riserva il diritto di modificare unilateralmente i prezzi riportati nel listino prezzi. La modifica sarà comunicata all'Acquirente e si applicherà a tutti gli Ordini ricevuti dal Venditore successivamente alla data in cui la modifica è stata comunicata all'Acquirente.
- 4.3 Ogni Vendita di Prodotti sarà soggetta ai termini e alle condizioni di garanzia stabilite nel successivo articolo 8.

5) Consegna

- 5.1 La consegna dei Prodotti sarà effettuata Ex Works (ICC INCOTERMS 2010). I rischi relativi alla perdita dei Prodotti saranno trasferiti all'Acquirente al momento della consegna presso gli stabilimenti del Venditore. I mezzi di trasporto saranno selezionati dal Venditore tenendo conto della loro adeguatezza in relazione agli specifici Prodotti da consegnare.

6) Pagamenti

- 6.1 Il Venditore emetterà le relative fatture al momento dell'accettazione dell'Ordine.
- 6.2 I pagamenti dovranno essere effettuati in Euro e necessariamente entro il termine di 30 giorni decorrenti dall'ultimo giorno del mese in cui la fattura è stata inoltrata dal Venditore all'Acquirente.
- 6.3 Il mancato pagamento entro il termine concordato darà diritto al Venditore (i) di chiedere all'Acquirente il pagamento degli interessi di mora al tasso stabilito dal D. Lgs. 231/02 e successive modifiche; (ii) di sospendere la consegna dei Prodotti e (iii) di risolvere ogni singola Vendita conclusa. La sospensione della consegna dei Prodotti o la risoluzione di ogni Vendita non darà diritto all'Acquirente di pretendere alcun risarcimento dei danni.
- 6.4 Il Venditore manterrà la proprietà dei Prodotti fino all'integrale pagamento del relativo prezzo. L'Acquirente dovrà compiere tutti gli adempimenti necessari richiesti dalle leggi locali al fine di rendere valida ed eseguibile nei confronti di tutti i terzi la presente clausola di riserva della proprietà, anche effettuando l'iscrizione di tale riserva negli appositi registri, ove richiesto localmente.
- 6.5 La compensazione di qualsiasi tipo tra gli importi dovuti dall'Acquirente al Venditore e gli importi eventualmente dovuti dal Venditore all'Acquirente non è consentita.
- 6.6 Ogni reclamo relativo ai Prodotti e/o alla consegna degli stessi non potrà in alcun caso giustificare la sospensione o il ritardo nel pagamento.

7) Non conformità

- 7.1 Qualsiasi difformità dei Prodotti consegnati all'Acquirente rispetto al tipo ed alla quantità indicata nell'Ordine dovrà essere denunciata per iscritto al Venditore entro cinque giorni dalla consegna dei Prodotti, da parte dell'Acquirente. Qualora la denuncia non venga comunicata entro il predetto termine, i Prodotti consegnati verranno considerati come conformi a quelli ordinati.

8) Garanzia

- 8.1 Salvo diverso accordo tra le parti, il Venditore garantisce che i Prodotti sono esenti da vizi/difetti per un periodo di 24 mesi decorrenti dalla data della fattura emessa dal Venditore.
- 8.2 La garanzia non opererà con riferimento a quei Prodotti i cui difetti sono dovuti a (i) mancanza di manutenzione o uso improprio; (ii) inosservanza delle istruzioni del Venditore relative al funzionamento, manutenzione ed alla conservazione dei Prodotti; (iii) riparazioni o modifiche apportate dall'Acquirente o da soggetti terzi senza la preventiva autorizzazione scritta del Venditore.
- 8.3 A condizione che il reclamo dell'Acquirente sia coperto dalla garanzia, il Venditore si impegnerà, a sua discrezione, a sostituire o riparare ciascun Prodotto o le parti di questo che presentino vizi o difetti.
- 8.4 Le spedizioni, dall'Acquirente al Venditore e dal Venditore all'Acquirente, dei Prodotti oggetto di reclamo saranno effettuate a costo e spese dell'Acquirente, salvo diverso accordo tra le parti.
- 8.5 Fatto salvo quanto previsto al precedente art. 8.3 e salvo il caso di dolo o colpa grave, il Venditore non sarà responsabile per qualsivoglia danno a cose o persone derivante e/o connesso ai vizi dei Prodotti, salvo nel caso in cui ciò sia prescritto da inderogabili disposizioni di legge. In ogni caso, il Venditore non sarà ritenuto responsabile per danni indiretti o consequenziali di qualsiasi natura quali, a titolo esemplificativo, le perdite derivanti da inattività o il mancato guadagno.
- 8.6 In ogni caso, il diritto dell'Acquirente al risarcimento dei danni sarà limitato ad un importo massimo pari al valore dei Prodotti che presentino difetti o vizi.

9) Diritti di proprietà intellettuale

- 9.1 Label è l'esclusivo titolare dei diritti di proprietà intellettuale relativi ai Prodotti. La loro comunicazione o utilizzo nell'ambito delle presenti Condizioni di Vendita non crea, in relazione ad essi, alcun diritto o pretesa in capo all'Acquirente. L'Acquirente si obbliga a non compiere alcun atto incompatibile con la titolarità di tali diritti di proprietà intellettuale.
- 9.2 La consegna dei Prodotti non comporta alcun trasferimento del relativo copyright. Il copyright sui Prodotti rimane di proprietà esclusiva del Venditore. L'Acquirente non dovrà in alcun modo imitare o copiare i Prodotti o qualsiasi parte essenziale dei marchi, disegni, modelli, brevetti e in particolare il software e il firmware.

10) Riservatezza

- 10.1 L'Acquirente si impegna a mantenere riservate e a non divulgare a terzi qualsiasi informazione tra cui, a titolo esemplificativo e non limitativo, marchi, documentazione tecnica, disegni, know-how, dati e corrispondenza, rivelata dal Venditore all'Acquirente o di cui l'Acquirente sia venuto a conoscenza durante o a seguito di una Vendita, a prescindere dal fatto che sia o meno contrassegnata come "Informazione Confidenziale".
- 10.2 L'Acquirente si impegna a porre in essere tutte le misure necessarie a mantenere la riservatezza di tali Informazioni Confidenziali e a rivelare le stesse esclusivamente ai propri dipendenti e nei limiti in cui tale rivelazione sia necessaria ai fini dell'adempimento delle obbligazioni previste dalle presenti Condizioni di Vendita.

11) Domicilio legale, legge applicabile e foro competente

- 11.1 Il Venditore è legalmente domiciliato presso la propria sede principale.
- 11.2 Le presenti Condizioni di Vendita e ogni singola Vendita saranno regolate da, e interpretate in conformità, alla Legge Italiana. La Convenzione di Vienna del 1980 sui contratti di vendita internazionali viene espressamente esclusa.
- 11.3 Tutte le controversie derivanti da o connesse alle presenti Condizioni di vendita e/o a ogni singola Vendita saranno soggette all'esclusiva giurisdizione del Tribunale di Parma.
- 11.4 Fatto salvo quanto previsto dal precedente articolo 11.3, il Venditore si riserva il diritto, quando promotore di un'azione legale in qualità di attore, di promuovere tale azione nel luogo di residenza dell'Acquirente, in Italia o all'estero.

1) Definitions

- 1.1 For the purposes of these general terms of sale (hereinafter referred to as "Terms of Sale"), the following terms shall be defined as follows:
- «Seller» or «Label»: shall indicate Label S.p.A.
 - «Purchaser»: shall indicate any company, organisation or legal person who is purchasing Products from the Seller;
 - «Products»: shall indicate the goods produced and/or assembled and sold by the Seller;
 - «Order(s)»: shall indicate any proposed purchase of Products sent from the Purchaser to the Seller via fax or email;
 - «Sale Agreement(s)»: shall indicate any contract of sale entered into upon receipt of the Purchaser's written acceptance of each individual Order, issued by the Seller.

2) Scope of application

- 2.1 These Terms of Sale shall apply to all Sales Agreements for Products throughout the world. In the event that the Seller and the Purchaser both agree to special conditions, signed by both Parties and in writing, which deviate from these Terms of Sale, then those special conditions either shall take precedence over and replace or shall incorporate the provisions set forth in these Terms of Sale.
- 2.2 The Seller reserves the right to add, amend or eliminate individual provisions from these Terms of Sale, with it being understood that such additions, amendments or eliminations shall apply to all Sales Agreements entered into beginning on the thirtieth day following the date on which the Purchaser was informed of the new Terms of Sale.

3) Orders and Sales Agreements

- 3.1 The Purchaser must send Orders to the Seller either via email to the address ordini@labelspa.it, or via fax to the number [+39 0521 675222], providing clear and specific indication of: the expected date of delivery; a description of the Products; the desired quantity; the price; and terms of delivery.
- 3.2 All orders received by Label shall be processed and (i) accepted by means of issuance of an order confirmation or (ii) rejected by means of issuance of a refusal report. It is understood that, in the event of a discrepancy between the delivery date indicated on the Order and the delivery date specified in the order confirmation, the latter shall take precedence as valid.
- 3.3 The Seller shall be entitled, for specific reasons associated with its own production needs or its market, to fulfil the Purchaser's order through any other company belonging to the Label Group.
- 3.4 The Sales Agreement shall be considered concluded, in accordance with the terms and conditions laid down in the Order, when the Purchaser receives from the Seller a written confirmation (said confirmation may also be sent via email, fax or other electronic means) or, in the absence of a written confirmation, at the time when the Products are delivered to the Purchaser.
- 3.5 Orders duly accepted by the Seller cannot be cancelled by the Purchaser without the Seller's written consent.

4) Product Price

- 4.1 The Product prices shall be those indicated on the Seller's price list in effect at the time when the Purchaser places its Order. Otherwise, in the event that the Product is not listed on the price list or the price list is not available, then the prices shall be those indicated in the Order and confirmed by the Seller in writing in the Order confirmation. Prices shall be calculated Ex Works (ICC INCOTERMS 2010), net of VAT and of any discount.
- 4.2 The Seller reserves the right to unilaterally modify the prices listed in the price list. Notice of said modification shall be provided to the Purchaser and shall apply to all Orders received by the Seller after the date in which notice of the modification was provided to the Purchaser.
- 4.3 Any Sales Agreement for Products shall be subject to the terms and conditions of warranty set forth in Article 8 below.

5) Delivery

- 5.1 Delivery of the Products shall be carried out Ex Works (ICC INCOTERMS 2010). Risks related to the loss of the Products shall be transferred to the Purchaser when the Products are delivered to the Purchaser at the Seller's premises. The means of transport shall be chosen by the Seller, taking into account their suitability to the specific Products to be delivered.

6) Payments

- 6.1 The Seller shall issue the invoices associated with an Order at the time of said Order's acceptance.
- 6.2 Payments must be made in EUR and within 30 days of the last day of the month in which the invoice was sent from the Seller to the Purchaser.
- 6.3 The Purchaser's failure to make payment within the agreed upon time frame shall entitle the Seller to: (i) demand that the Purchaser pay default interest at the rate established by Italian Legislative Decree 231/02 and its subsequent amendments and additions; (ii) suspend delivery of the Products and (iii) cancel each individual Sales Agreement that has been entered into. The suspension of Product delivery or the cancellation of all Sales Agreements shall not entitle the Purchaser to claim any damages.
- 6.4 The Seller shall maintain ownership of the Products until their price has been paid in full. The Purchaser must ensure that all necessary local legal requirements are met in order that this retention of ownership clause be made valid and enforceable against all third parties; the Purchaser must also ensure that this retention of ownership is recorded in the proper registers, where required under local law.
- 6.5 Sums owed by the Purchaser to the Seller may not be applied as compensation for sums owed by the Seller to the Purchaser and vice versa.
- 6.6 No complaint regarding the Products and/or their delivery may be used to justify a suspension of or delay in payment.

7) Non-conformity

- 7.1 The Purchaser must report, in writing, any discrepancy between the Products delivered to the Purchaser and the type and quantity listed in the Order within five days of Product delivery. If said report is not made within the timeframe stated above, then the Products delivered shall be considered to be as ordered.

8) Warranty

- 8.1 Unless the Parties should come to a different agreement, the Seller hereby warrants that the Products shall be without flaws/defects for a period of 24 months following the issuance of the invoice by the Seller.
- 8.2 The warranty shall not apply to those Products whose defects arise from: (i) a lack of maintenance or improper use; (ii) failure to follow the Seller's instructions regarding Product operation, maintenance and preservation; (iii) repairs or modifications performed by the Purchaser or third parties without the Seller's prior written consent.
- 8.3 Provided that the Purchaser's claim is covered by the warranty, the Seller shall, at its discretion, either replace or repair each Product or the parts thereof that present flaws or defects.
- 8.4 The shipment, from the Purchaser to the Seller and from the Seller to the Purchaser, of the Products that are the object of the claim shall be carried out at the cost and expense of the Purchaser, unless the Parties have come to a different agreement.
- 8.5 Without prejudice to that which is set forth in Article 8.3 above, and barring cases of wilful misconduct or gross negligence, the Seller shall not be liable for any damages to persons or property arising from and/or associated with flaws in the Products, except in cases where said liability is mandatory under applicable law. In any event, the Seller shall not be held liable for indirect or consequential damages of any nature, such as, for instance, losses arising from downtime or loss of earnings.
- 8.6 In any event, the Purchaser's right to compensation for damages shall be limited to a maximum amount equal to the value of the Products presenting flaws or defects.

9) Intellectual Property Rights

- 9.1 Label is the sole owner of the intellectual property rights relating to the Products. Their transmission or use within the framework of these Terms of Sale does not grant the Purchaser any right or claim to them. The Purchaser hereby undertakes not to take any action that would conflict with the ownership of said intellectual property rights.
- 9.2 Delivery of the Products in no way signifies the transfer of the relative copyrights. Copyrights for the Product remain the exclusive property of the Seller. The Purchaser shall in no way imitate or copy the Products or any essential part of the trademarks, designs, models, patents and, in particular, of the software or firmware.

10) Confidentiality

- 10.1 The Purchaser undertakes to maintain the confidentiality of and refrain from disclosing to third parties any and all information either revealed to the Purchaser by the Seller or which may come into the Purchaser's possession before or after a Sale, regardless of whether or not it is classified as "Confidential Information"; this includes but is not limited to trademarks, technical documentation, designs, know-how, data and correspondence.
- 10.2 The Purchaser undertakes to put in place all measures necessary to protect the confidentiality of said Confidential Information and to disclose it solely to its own employees only insofar as is necessary for the fulfilment of the obligations set forth in these Terms of Sale.

11) Legal domicile, applicable law and jurisdiction

- 11.1 The Seller has designated its head office as its legal domicile.
- 11.2 These Terms of Sale and each individual Sales Agreement shall be subject to and interpreted in compliance with Italian Law. The 1980 Vienna Convention on the International Sale of Goods is expressly excluded.
- 11.3 Any and all disputes arising from or related to these Terms of Sale and/or to any individual Sales Agreement shall be subject to the exclusive jurisdiction of the Courts of Parma.
- 11.4 Without prejudice to that which is set forth in Article 11.3 above, the Seller reserves the right, when acting in the role of claimant in a legal action, to bring that action against the Purchaser in the Purchaser's place of residence, whether in Italy or abroad.



Tutti i contenuti del presente catalogo/listino sono stati controllati con la massima attenzione, **Label** tuttavia declina ogni responsabilità per eventuali omissioni, errate indicazioni e descrizioni, imprecisioni ed errori di stampa di qualunque genere. Per questa ragione fanno fede i prezzi dell'ultima versione listino, consultabile nell'area riservata del sito **labelspa.com**.

I disegni e le illustrazioni sono da considerarsi indicativi del prodotto, ma non costituiscono documentazione tecnica e il Cliente deve verificare che siano applicabili alle proprie esigenze specifiche.













LABEL SI RISERVA IL DIRITTO DI MODIFICARE LE SPECIFICHE DEI PRODOTTI SENZA PREAVVISO.

The content of this catalogue/price list has been carefully checked, however **Label** accepts no liability for any omissions, wrong information and descriptions, inaccuracies and printing errors of any kind. For this reason, the prices in the latest version of the price list, which can be found in the reserved area of the web site **labelspa.com**, shall apply. The drawings and illustrations are intended to be indicative of the product, but do not constitute technical documentation and the Customer must verify that they are applicable to its specific needs.

LABEL RESERVES THE RIGHT TO CHANGE PRODUCT SPECIFICATIONS WITHOUT NOTICE.



LEGENDA PITTOGRAMMI TABELLE - TABLES PICTOGRAMS LEGEND

	Codice <i>Code</i>		Descrizione <i>Description</i>		Spessore muro <i>Wall thickness</i>		Confezione <i>Package</i>
	Funzionamento Automatico <i>Automatic operation</i>		Funzionamento Manuale <i>Manual operation</i>		Tenuta Ermetica <i>Hermetic seal</i>		Tenuta Semplice <i>Simple seal</i>
	Battente <i>Swing</i>		Anta <i>leaf</i>		Scorrevole <i>Sliding</i>		Finitura <i>Finish</i>

UNITÀ DI MISURA - UNIT OF MEASUREMENT

1 m = 3' 3" - 2 m = 6' 6" - 3 m = 9' 9" - 4 m = 13' 2" - 1000 mm = 1 m - 1000 mm = 3' 3" - 2000 mm = 6' 6" - 3000 mm = 9' 9" - 4000 mm = 13' 2"

1 kg = 2.204 lb - 70 kg = 154.324 lb - 90 kg = 198.416 lb - 130 kg = 286.601 lb - 250 kg = 551.156 lb

1 °C = 33,8 °F - -15 °C / +50 °C = +5 °F / +122 °F



ANSI/CAN/UL325



AZIENDA CERTIFICATA
SISTEMA QUALITÀ
UNI EN 9001:2015





INNOVATION IS AN OPEN DOOR



LABEL S.p.A. Via Umberto Ilariuzzi 17/A - 43126 San Pancrazio Parmense (PARMA) Italy
T. +39 0521 6752 - infocom@labelspa.it

www.labelspa.com

